

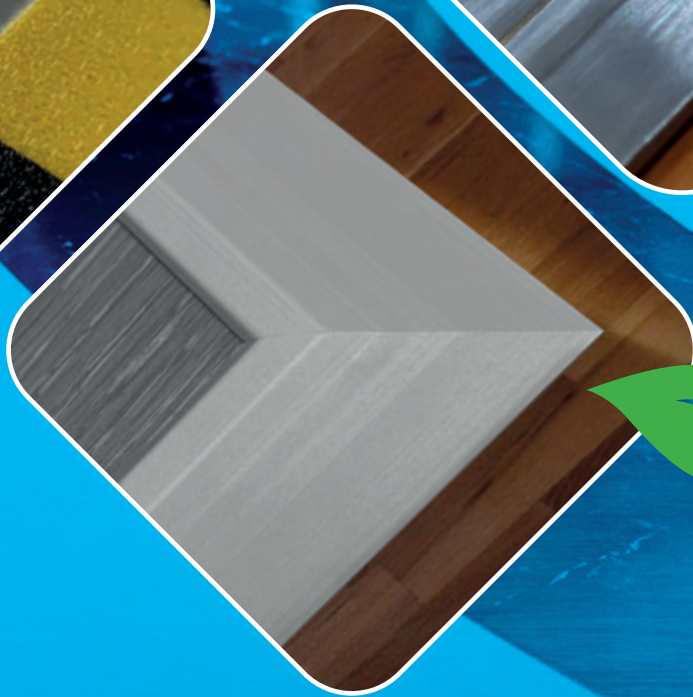

Auer Metallprofile

GmbH

HAUPTKATALOG | main catalog
ohne Preisangaben | without prices

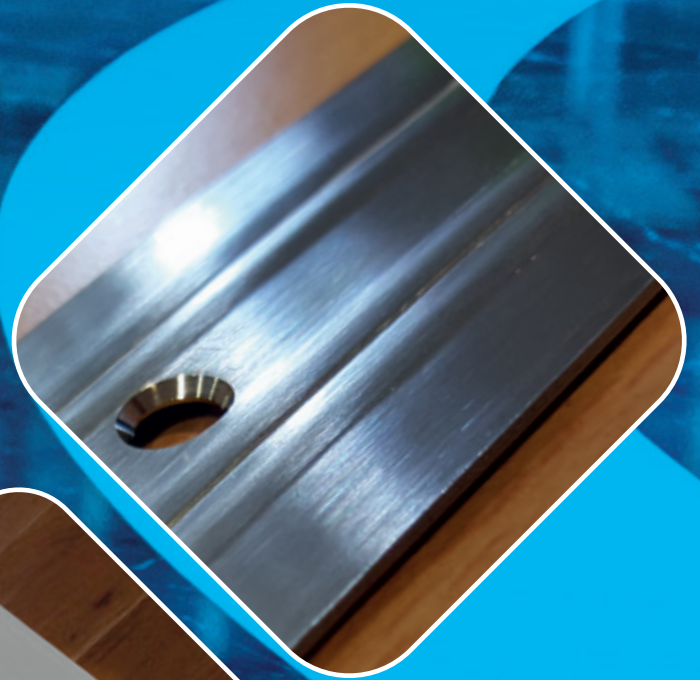
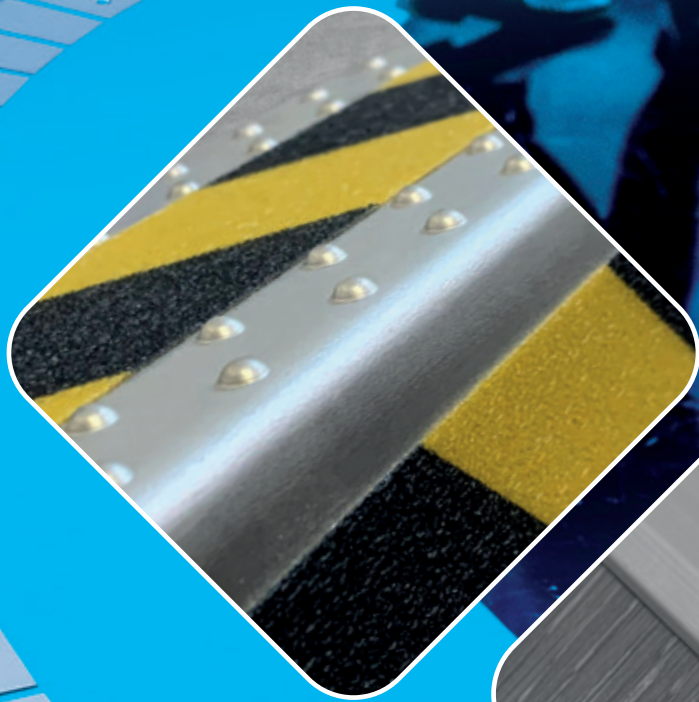

2024



Dirk Rohde DW - 14
Geschäftsführer
general manager



Manja Ulbricht DW - 10
Geschäftsführerin
general manager



Jan Rohde DW - 21
Produktionsleiter / Vertrieb
production manager / distribution



Jan Ulbricht DW - 29
Vertrieb / Laserbeauftragter
distribution / laser representative



Uwe Albrecht DW - 27
Vertrieb / Reklamations-
beauftragter
distribution / complaint officer



Frank Wollrab DW - 12
Vertrieb
distribution



Nicole Scheppan DW - 15
Auftragsannahme
order acceptance



Angela Rohde DW - 31
Auftragsannahme
order acceptance



Katrin Rohde DW - 16
Buchhaltung
accounting



Kathi Wollrab DW - 28
Rechnungslegung
invoice department



Silke Nostitz DW - 17
Vertrieb
distribution



Carmen Sachse DW - 18
Vertrieb / Marketing
distribution / marketing

Sie erreichen uns telefonisch unter:
You can reach us by phone at:

+ 49 (0) 3771 / 2868-0

Für Angebote und Ausschreibungen:
For inquiries:

Angebot@Auer-Metallprofile.de

Für Ihre Bestellungen:
For your order:

Order@Auer-Metallprofile.de

Für alles andere:
For everything else:

Info@Auer-Metallprofile.de

Auer.Metallprofile



Die Auer Metallprofile-App

Ihre Profilauswahl für unterwegs – ab jetzt im Apple- und Google-Store erhältlich!

Auer Metallprofile App - your profile selection to go - now available in Apple and Google Store!

FARB- und MUSTERNUMMERNVERZEICHNIS / COLOUR and CASE NUMBER LIST

Aluminium farbig eloxiert
aluminium anodized

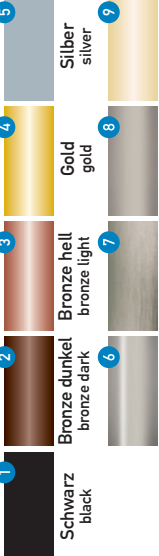

1 Schwarz
black

2 Bronze dunkel
bronze dark

3 Bronze hell
bronze light

4 Gold
gold

5 Silber
silver

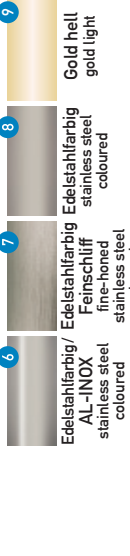

6 Edeltahlfarbig/
AL-INOX
stainless steel
coloured

7 Edeltahlfarbig
Feinschliff
fine-honed
stainless steel
coloured

8 Edeltahlfarbig
Edeltahlfarbig
stainless steel
coloured

9 Gold hell
gold light

Messing / Edeltahl
brass / stainless steel

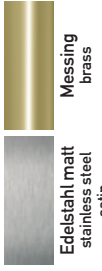

Messing
brass

Edeltahl matt
stainless steel
satin

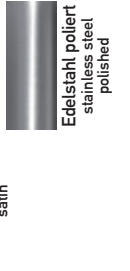

Edeltahl poliert
stainless steel
polished

Aluminium abriebfest emailiert
aluminium hard wearing enamelled



Blau
blue

Silber metallic
silver metallic

Dunkelgrau
dark grey

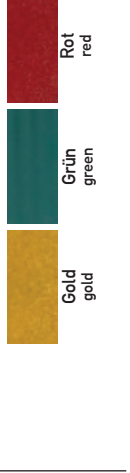

Gold
gold

Grün
green

Rot
red

Kunststoffoberfläche in Holzdekor
plastic surface wood decor



Eiche rustikal
rustic oak

Kirschbaum
cherry wood

Ahorn
maple



Buche
beech

Eiche
oak

farbiger Kunststoff
coloured PVC



Schwarz
black

Grau
grey

Braun
brown

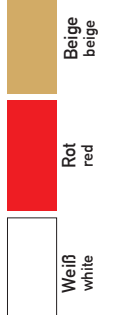

Beige
beige

Rot
red

Weiß
white

Koffer Nr./case no.	Seite page	Koffer Nr./case no.	Seite page	Koffer Nr./case no.	Seite page	Koffer Nr./case no.	Seite page	Koffer Nr./case no.	Seite page	Koffer Nr./case no.	Seite page	Koffer Nr./case no.	Seite page	Koffer Nr./case no.	Seite page
1	51	94	16	173	136	244	149	308	98	380	121	446	80	513	90
2	58	95	9	174	136	246	150	309	90	381	121	447	99	514	91
3	61	97	10	175	136	248	159	310	117	382	121	448	100	515	91
4	62	98	20	178	137	249	159	311	35	383	15	449	101	516	96
5	53/54	99	6	179	137	250	65	312	35	384	16	450	102	517	96
6	56	100	6	180	144	251	93	315	105	385	16	451	103	518	121/127
7	57	101	88	182	146	252	31	316	105	386	26	452	113	519	27
8	62	105	85	183	146	253	31	317	105	387	75	453	113	520	27
9	69	108	80	184	147	254	31	318	35	388	7	454	113	521	27
10	55	109	81	185	147	255	95	319	35	389	8	455	113	522	27
11	55	110	81	186	147	256	97	320	35	394	30	456	113	523	38
12	59/60	111	82	187	147	257	98	322	133	395	30	457	66/114	524	50
13	52	112	87	189	141	258	79	323	134	396	30	458	66/114	525	78
14	52	119	149	190	141	259	88	324	134	397	47	461	116	526	78
15	58	120	149	194	145	260	88	325	135	398	47	462	117	527	78
16	58	121	22	197	142	261	88	326	135	399	31	463	117	528	78
17	84	127	13	198	143	262	86	327	105	400	31	464	121	529	78
18	79	128	13	199	143	263	87	328	36	401	31	465	122	530	79
19	74	129	13	200	143	264	26	329	36	402	31	466	122	531	79
20	74	130	73	201	33	265	86	330	36	403	31	467	122	532	81
21	83	131	73	202	33	266	15	331	36	404	31	468	123	533	82
22	75	132	70	203	33	267	18	332	36	405	31	469	123	534	83
23	74	133	70	204	33	268	75	333	18	406	32	470	123	535	84
24	80	134	26	205	20	269	75	334	17	407	32	471	124	536	78
25	138	135	26	206	34	270	20	336	149	408	32	472	124	537	17
26	138	136	65	207	34	271	20	337	42	409	32	473	112	538	66/114
27	76	137	71	208	34	272	99	338	42	410	32	474	14	539	66/114
28	76	138	107	209	43	273	100	339	13	411	32	475	14	540	66/114
29	76	139	107	210	44	274	101	340	18	412	64	476	14	541	66/114
30	76	140	107	211	44	275	102	341	17	413	67/111	477	45	542	66/115
31	130	141	108	212	45	276	103	342	7	414	67/111	478	83	543	66/115
32	127	142	50	213	45	277	104	343	7	415	67/111	479	133	544	66/115
33	128	143	50	214	45	278	159	344	8	416	67/111	480	77	545	66/115
34	128	144	50	215	45	279	159	345	8	417	67/111	481	43	546	66/115
35	129	145	61	216	45	280	159	346	73	418	67/111	482	134	547	66/115
36	128	146	22	217	45	281	131	347	73	419	67/111	483	138	548	67/111
51	151	147	21	218	45	282	77	348	73	420	67/111	484	135	549	67/111
57	151	148	109	219	45	283	77	349	69	421	67/111	486	22	550	67/111
68	144	149	109	220	45	284	77	350	63	422	67/111	487	23	551	67/111
69	144	150	109	221	45	285	67/111	351	106	423	67/111	489	25	552	67/111
70	144	151	109	222	45	286	67/111	352	31	424	67/111	490	25	553	67/111
71	145	152	109	223	112	287	67/111	353	31	425	67/111	491	28	554	67/111
72	145	153	108	224	112	288	67/111	354	31	426	67/111	492	28	555	67/111
73	141	154	33	225	112	289	67/111	355	31	427	86	493	40	556	67/111
74	140	155	61	226	112	290	67/111	356	150	428	66/114	494	41	557	67/111
75	140	156	118	227	45	291	67/111	357	150	429	140	495	41	558	67/111
76	140	157	118	228	31	292	116	358	150	430	142	496	18	559	67/111
79	159	158	118	229	31	293	116	361	152	431	142	498	96	560	68
80	25	159	118	230	48	294	116	362	152	432	149	499	96	561	68
81	21	160	120	231	48	295	116	363	152	433	151	500	24	562	68
82	21	161	120	232	48	296	116	364	152	434	146	501	84	563	68
83	12	162	120	233	48	297	116	366	152	435	15	502	85	564	68
84	12	163	120	234	48	298	66/114	367	32	436	15	503	42	565	68
85	6	164	108	235	46	299	66/114	368	32	437	16	504	24	566	68
86	25	165	129	236	46	300	66/114	369	19	438	34	505	24	567	68
87	9	166	129	237	65	301	125	370	19	439	64	506	71	568	68
88	4/5	167	131	238	65	302	125	371	140	440	64	507	37	569	118
89	2/3	168	131	239	65	303	125	372	7	441	64	508	37	570	119
90	6	169	131	240	65	304	125	373	23	442	67/111	509	37	571	119
91	10/11	170	136	241	47	305	125	374	23	443	67/111	510	37	572	119
92	22	171	136	242	149	306	95	375	23	444	67/111	511	40	573	119
93	85	172	136	243	149	307	97	379	142	445	67/111	512	41	574	119

Unsere AMP - Außendienstmitarbeiter

Our AMP field service employees

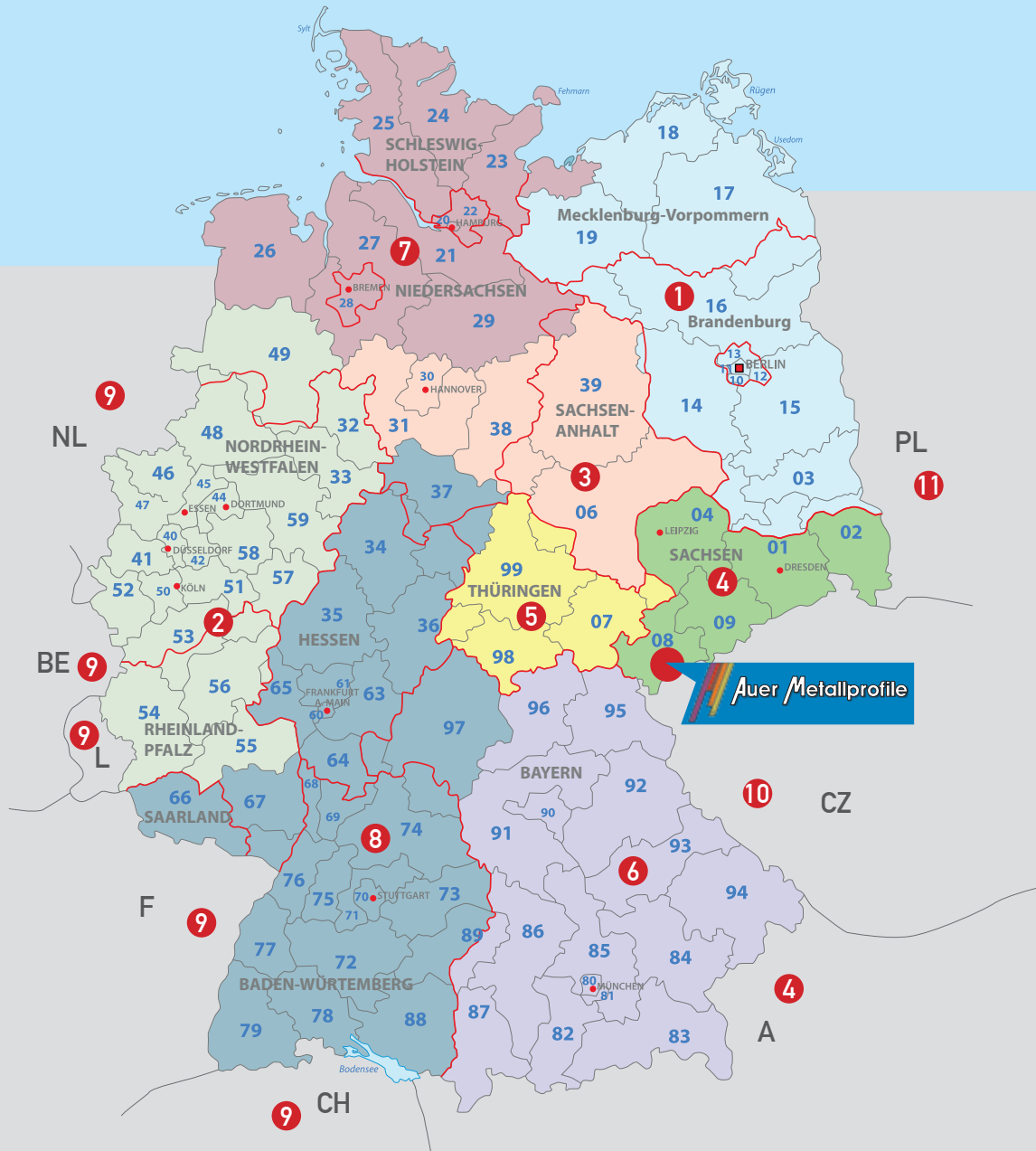

Abweichungen möglich – bei Rückfragen +49 (0)3771 / 28 68-0 | deviations possible – for any questions +49 (0)3771 / 28 68-0

1 Marco Kalbhen Handelsvertretung

D-14476 Fahrland
Mobil: **0175/20 47 971**
Email: info@kalma-handel.de
Fax: 033208/20 89 66

4 Matthias Bäßler Handelsvertretung

D-04643 Geithain
Mobil: **0171/82 39 292**
Email: info@baessler-werkzeug.de
Fax: 034341/40 804

7 Andrea Facklam Handelsvertretung

D-22927 Großhansdorf
Mobil: **0160/70 13 414**
Email: A.Facklam@t-online.de
Fax: 04102/69 14 89

9 Michel Kuentz E.I.R.L.

F - 68740 Rumersheim-Le-Haut
Mobil: **0033 633/10 12 56**
Email: michelkuentz@orange.fr

2 André Schlepphorst ABS-Leisten-Vertriebsges.

Mobil: **0151/29 50 17 82**
Email: Kontakt@ABS-Leisten.de
Schlepphorst@ABS-Leisten.de

5 Marcel Bäßler Handelsvertretung

D-04654 Frohburg/OT Flößberg
Mobil: **0163/47 74 765**
Email: info@handelsagentur-baessler.de

8 Silke & Michael Davin Handelsvertretung

D-63637 Jossgrund-Lettgenbrunn
Fax: 06059/90 75 13

Silke Davin
Mobil: **0173/35 96 854**
Email: silke.davin186@yahoo.de

10 Veronika Burianová RESKO Tachov s.r.o.

CZ-34701 Tachov
Tel.: **00420 374/78 76 52**
Mobil: **00420 725/92 36 30**
Email: info@resko-tachov.cz

3 Martin Paetzel Handelsvertretung

D-39387 Oschersleben
Mobil: **0177/28 78 533**
Email: mpae2002@freenet.de
Fax: 03949/51 15 80

6 Tanja Wehnl Handelsagentur

D-91338 Igensdorf
Mobil: **0170/21 76 854**
Email: tanja.wehnl@handelsagentur-wehnl.de
Fax: 09192/99 32 53

9 Michael Davin Handelsvertretung

Mobil: **0172/61 93 307**
Email: michael.davin@t-online.de

11 Grzegorz Matys Centrum Profili

PL-05-092 Lomianki k/W-wy
Tel.: **0048 502/02 90 49**
Email: sklep@auer-metallprofile.pl

NEUHEITEN 2024

NEWS 2024



537

NEU:
Treppenkante
80 x 50 x 3 mm
Aluminium
eloxiert

NEW:
stair nosing
80 x 50 x 3 mm
aluminium
anodized

NEU: in 2 m Länge
bei allen Treppenkanten mit
Emailebeschichtung in
verschiedenen Farben, mit und
ohne nachleuchtenden Rillen

NEW: in 2 m length
at all stair nosings with enamel coating
in different colours, with and
without photoluminescent grooves

519 - 522

NEU: Farben
schwarz und
edelstahlfarbig
bei Eckprofilen 30 x 40 mm,
Aluminium eloxiert

NEW: colours black and
stainless steel coloured
at stair nosings 30 x 40 mm,
aluminium anodized

413 538 - 565

NEU: Breiten 30/35/45 mm
bei Flachprofil/Flachschwelle
Edelstahl matt

NEW: width 30/35/45 mm
at flat threshold
stainless steel matt

566 - 568

NEU: Verbundschwelle
in Breiten 40/50/60 mm

NEW: composite threshold
in width 40/50/60 mm

530 - 535

NEU: Farbe schwarz
bei Einschubprofile glatt,
Aluminium eloxiert,
mit und ohne Nase,
verschiedene Höhen

NEW: colour black
at insert profile smooth,
aluminium anodized,
with and without nose,
in different heights

31

NEU:
Dehnungsfugenprofil 2 - 6 mm
in Aluminium pressblank
mit schwarzer Silikoneinlage

NEW:
expansion gap profile 2 - 6 mm,
in aluminum mill-finish with black
silicone insert

31

NEU: 3 m Länge
bei Dehnungsfugenprofil
2 - 6 mm, Aluminium
pressblank mit grauer
Silikoneinlage

NEW: 3 m length at expansion
gap profile, aluminum mill-finish,
with gray silicone insert

32

NEU:
Höhen 8/10/11/12,5/15 mm
bei Fliesentrennprofil
Aluminium schwarz eloxiert

NEW:
height: 8/10/11/12,5/15 mm
at tile separation profile
aluminum black anodized

NEUHEITEN 2024

NEWS 2024



569

NEU: Maß
100 x 10 x 1,7 mm
Sockelleiste
Typ L100,
Aluminium
stranggepresst

NEW: dimension
100 x 10 x 1.7 mm
skirting type L100,
aluminum extruded

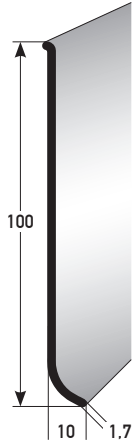

570

NEU:
Außenecke
für L-Sockelleisten,
Druckguss
L40 / L60 /
L80 / L100

NEW: outside corner
for L-skirtings,
diecast
L40 / L60 / L80 / L100



571

NEU:
Innenecke für
L-Sockelleisten,
Druckguss
L40 / L60 /
L80 / L100

NEW: inside corner
for L-skirtings,
diecast
L40 / L60 /
L80 / L100



572

NEU: Verbinder
für L-Sockelleisten
Druckguss
L40 / L60 /
L80 / L100

NEW: connector
for L-skirtings,
diecast
L40 / L60 /
L80 / L100



573 574

NEU: Endstücke
links und rechts
für L-Sockelleisten
Druckguss
L40 / L60 /
L80 / L100

NEW: end caps
left and right
for L-skirtings,
diecast
L40 / L60 / L80 / L100



25 26

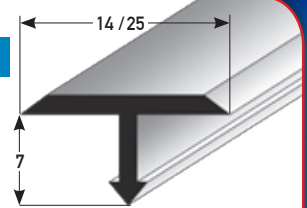

NEU: 3 m Länge
bei T-Profile 14 und 25 mm,
Edelstahl matt

NEW: 3 m length at T-profiles
14 and 25 mm, stainless steel matt



AMP-Standard-Musterkoffer

AMP standard
example case 2023



AMP-Läuferstangen-Musterkoffer

AMP stair rods
example case



Seite / page	Produktkategorie / product categories	Form / shape	
1 - 28	1. Winkelprofile und Treppenkanten aus Aluminium und Messing 1. angle edges and stair nosings out of aluminium + brass		
<p>Winkelprofile / Treppenkanten / Vorstoßprofile / Fassonprofile / wendbare Treppenseitenprofile / ALU-Treppeninnenecken / Eckprofile Kombi-Treppenkanten mit Einlagen / Doppelsein Schub-Treppenkanten</p> <p>angle edges / stair nosings / edge profiles / fasson stair nosings / turnable stair side profiles / aluminium stair inside corners / corner profiles combination stair nosings with inserts / double insert stair nosings</p>	29 - 38	2. Treppenkanten aus Edelstahl 2. stair nosings out of stainless steel	
<p>Edelstahl-Treppenkanten: INOX PROTECT / profilierte Riffelung / gefräste Riffelung / Prägelochung / Prägelochung + Anker / gezogen V4A / Noppenprägung / Fliesen-Treppenkante / Edst.-Einschubprofile mit Nase / Edst.-Treppeninnenecken</p> <p>stainless steel stair nosing: INOX PROTECT / fluted raffle / antislip fluting / embossed punching / embossed punching + anchor / drawn V4A / nub embossing / tile stair nosing / stainless steel nosed insert profile / stainless steel stair inside corner</p>	39 - 48	3. Wand-, Kantenschutz- & Spezialprofile aus Edelstahl + Aluminium + Messing 3. wall + corner protection and special profiles out of stainless steel + aluminium + brass	
<p>Wandprofile / Eckschutzwinkel / Edelstahl-Deko-Winkel / Edst.-Einschubprofile / Edst.-Ausgleichsprofile / Miniwinkel Edelstahl + Messing / Edelstahl-Spezialprofile</p> <p>wall profiles / corner protection angles / stainless steel deco-angles / stainless steel insert profiles / stainless steel leveling profiles / stainless steel special profiles</p>	49 - 71	4. Übergangprofile aus Aluminium, Edelstahl und Messing 4. connecting profiles out of aluminium + stainless steel + brass	
<p>Übergangprofile Aluminium / Messing / Edelstahl / Edelstahl-Übergangprofile: profilierte Riffelung / gezogen V4A / gekantet Flachswellen / INOX PROTECT Aluminium-Flachswellen / Abschlussprofile / Anpassungsprofile Sockelprofile</p> <p>connecting profiles aluminium / brass / stainless steel / stainless steel cover profiles: fluted raffle / drawn V4A / edged / flat threshold INOX PROTECT / aluminium flat threshold / adaptation profiles / levelling profiles / plinth profiles</p>			



Seite / page	Produktkategorie / product categories	Form / shape
72-88	5. Einschub- und Anstoßprofile aus Aluminium 5. insert profiles out of aluminium	
89-93	6. LED und Service 6. LED + service	
94-109	7. Systemprofile aus Aluminium und Edelstahl für 4 - 24 mm Beläge 7. system profiles out of aluminium + stainless steel for 4 - 24 mm floorings	
110-121	8. Sockelleisten aus Edelstahl und Aluminium 8. skirtings out of stainless steel + aluminium	



Seite / page	Produktkategorie / product categories	Form / shape
126-138	9. Fliesentrenn-, Dehnungsfugen-, Bau- & T-Profile aus Aluminium, Edelstahl, Messing & PVC	
	9. ceramic tile separation profiles + expansion gap profiles out of aluminium + stainless steel + brass + PVC	
	<p>Fliesentrennprofile / Flexible Fliesentrennpr. / Dehnungsfugenprofile / Spezial-Dehnungsfugenprofile, Fugenbreite bis 20 mm / SUPER-Dehnungsfugenprofile, Fugenbreite 20/ 35 mm / Wellenverbinder / Bauprofile: Winkel / U-Profile / T-Profile + Befestigung / Rohre / Flachprofile / Vierkantrohre</p> <p>ceramic tile separation profiles / flexible ceramic tile separation profiles / expansion gap profiles / special expansion gap profile, over 20 mm joint width / wave connector / super expansion gap profile, joint width 20/ 35 mm / T-profiles + fastening / pipes / flat profiles / rectangular pipes</p>	
139-147	10. Läuferstangen aus Messing und Edelstahl	
	10. stair rods out of brass + stainless steel	
	<p>Läuferstange Ø 10 / 13 / 16 / 25 mm + Zubehör / Dreikantläuferstange 16x16 mm + Zubehör / Teppichschrauben & -nägel</p> <p>stair rod Ø 10 / 13 / 16 / 25 mm + accessories / triangular stair rod 16x16 mm + accessories / carpet screws + carpet nails</p>	
148-152	11. Reparaturwinkel f. Treppen und PVC-Profile	
	11. repair angles for stairs + PVC profiles	
	<p>Reparaturwinkel Edelstahl + verzinkter Stahl / Rund-Reparaturwinkel / PVC-Profile: PVC-Einfassleisten ein- u. doppelseitig / PVC-Übergangsprofil / Stufenmattenwinkel / Knickwinkel / Weichsockelleisten / Hohlkehlprofil / PVC-Treppenkanten</p> <p>repair angles stainless steel + galvanized steel / round repair angles / PVC profiles: insert profiles single and double-sided / PVC connecting profile / PVC-angles for stair mats / edge profiles / soft skirtings / hollow profile / stair nosings</p>	
153-160	12. Zubehör	
	12. accessories	
	<p>Fußbodenverlegebänder / Montagekleber / Schrauben / Dübel / Ringnägel / Leistenstifte / Türstopper / Wegmarkierungsronden / Edelst.-Heizrohrrosetten / Lüftungsbleche</p> <p>tapes / builders adhesive / screws / dowels / rifled nails / pins / door stopper / trail marker ronden / stainless steel heating pipe rosettes</p>	
161-165	13. Hinweise und AGB	
	13. hints + terms and conditions	
	<p>Verlegehinweise / AGB - Liefer- & Zahlungsbedingungen</p> <p>installation tips / terms and conditions - delivery and payment</p>	



1. Winkelprofile und Treppenkanten aus Aluminium und Messing

1. angle edges and stair nosings out of aluminium + brass

1

2. Treppenkanten aus Edelstahl

2. stair nosings out of stainless steel

2

3. Wand-, Kantenschutz- und Spezialprofile aus Edelstahl, Aluminium und Messing

3. wall, corner protection and special profiles out of stainless steel + aluminium + brass

3

4. Übergangprofile aus Aluminium, Edelstahl und Messing

4. connecting profiles out of aluminium + stainless steel + brass

4

5. Einschub- und Anstoßprofile aus Aluminium

5. insert profiles out of aluminium

5

6. LED + Service

6. LED + service

6

7. Systemprofile aus Aluminium und Edelstahl für 4 - 24 mm Beläge

7. system profiles out of aluminium + stainless steel for 4 - 24 mm floorings

7

8. Sockelleisten aus Edelstahl und Aluminium

8. skirtings out of stainless steel + aluminium

8

9. Fliesentrenn-, Dehnungsfugen-, Bau- & T-Profile aus Aluminium, Edelstahl, Messing und PVC

9. ceramic tile separation profiles + expansion gap profiles + building profiles + T-profiles out of alu. + stainl. steel + brass + PVC

9

10. Läuferstangen aus Messing und Edelstahl

10. stair rods out of brass + stainless steel

10

11. Reparaturwinkel für Treppen und PVC-Profile

11. repair angles for stairs + PVC profiles

11

12. Zubehör

12. accessories

12

13. Hinweise und AGB

13. hints + terms and conditions

13

1. Winkelprofile und Treppenkanten aus Aluminium und Messing

1. angle edges and stair nosings
out of aluminium + brass

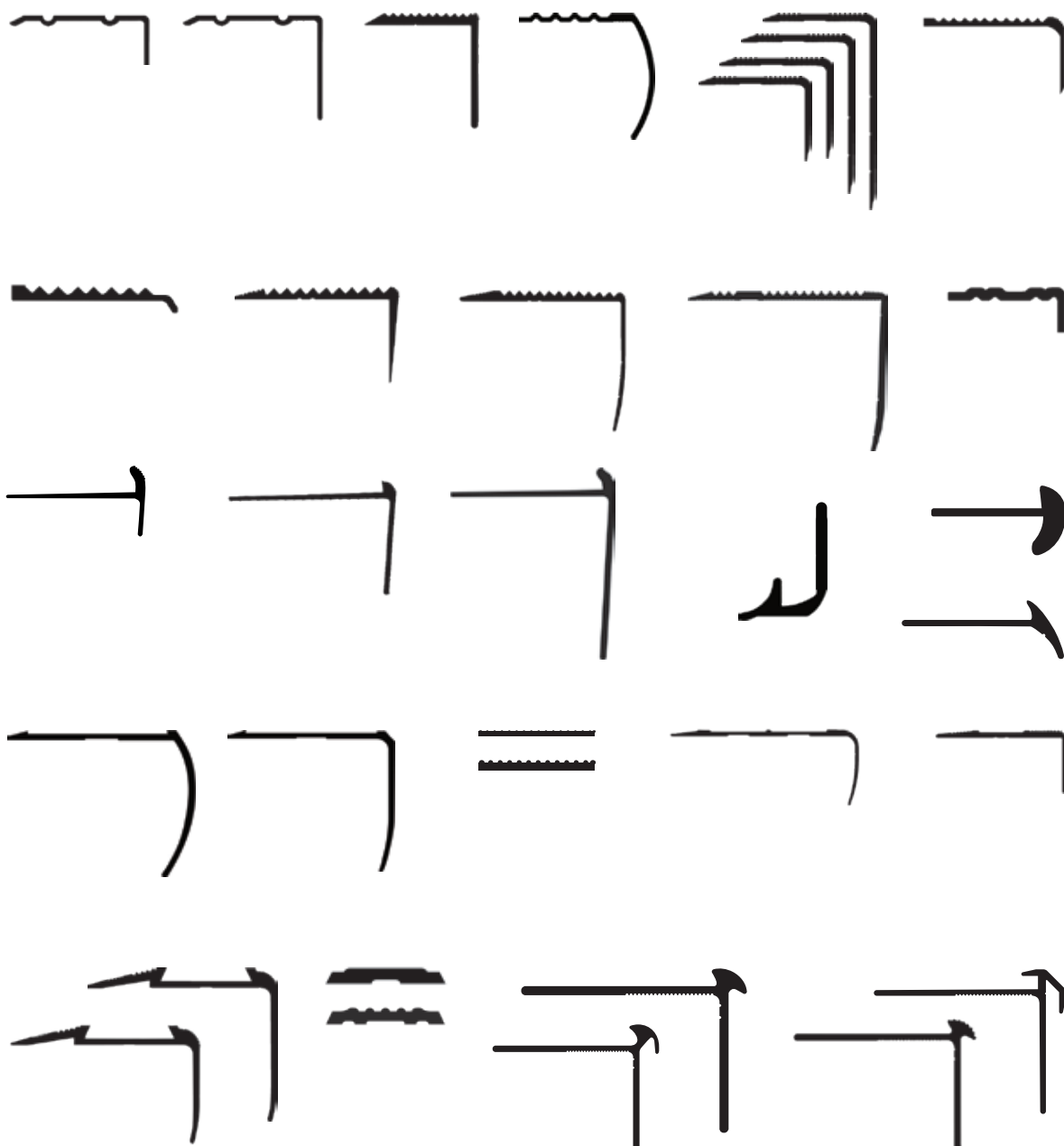

Andere Eloxalfarben siehe Abschnitt 6, Lieferzeit 14 Tage / other anodized colours see section 6, delivery time 14 days

Profi-Pack à 10 Stück im Bund			
professional packing à 10 pcs.			
Farbe / colour	L / l (m)	Art. / ref.	€ / Stk. / pcs.

SB-Pack incl. Schr. / Dübel: VE 20 Stk.	
self-service-pack with screws / dowels; à 20 pcs.	
Art. / ref.	€ / Stk. / pcs.

89 Winkelprofil 10 x 24,5 mm, Aluminium eloxiert, gebohrt

angle edge 10 x 24,5 mm, aluminium anodized, drilled

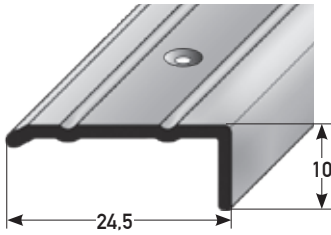

silberfarbig silver	0,8	04480-2	
	0,9	04490-1	
	1,0	04500-7	
	1,2	04510-6	
	2,0	04520-5	
goldfarbig gold	0,8	04580-9	
	0,9	04590-8	
	1,0	04600-4	
	1,2	04610-3	
	2,0	04620-2	
bronzefarbig hell bronze light	0,8	04680-6	
	0,9	04690-5	
	1,0	04700-1	
	1,2	04710-0	
	2,0	04720-9	
bronzefarbig dunkel bronze dark	0,8	04780-3	
	0,9	04790-2	
	1,0	04800-8	
	1,2	04810-7	
	2,0	04820-6	
gold hell gold light	0,8	70580-2	
	0,9	70582-6	
	1,0	70584-0	
	1,2	70586-4	
	2,0	70588-8	
edelstahlfarbig Feinschliff fine-honed stainless steel, coloured	0,8	70592-5	
	0,9	70594-9	
	1,0	70596-3	
	1,2	70598-7	
	2,0	70600-7	
schwarz black	1,0	72024-9	
	2,7	72026-3	

04491-8	
04501-4	
04521-2	
04531-1	
04591-5	
04601-1	
04621-9	
04631-8	
04691-2	
04701-8	
04721-6	
04731-5	
04791-9	
04801-5	
04821-3	
04831-2	
70604-5	
70606-9	
70608-3	
70610-6	
70612-0	
70614-4	
70616-8	
70618-2	
72028-7	
72030-0	

Holzdekorfolie / wood decor	Buche beech	
	1,0	38700-8
	2,7	38710-7
	Eiche oak	
	1,0	38720-6
	2,7	38730-5
	Ahorn maple	
	1,0	38740-4
	2,7	38750-3
	Kirschbaum cherry wood	
	1,0	38760-2
	2,7	38765-7
Eiche rustikal rustic oak		
1,0	38770-1	
2,7	38775-6	

38701-5	
38711-4	
38721-3	
38731-2	
38741-1	
38751-0	
38761-9	
38766-4	
38771-8	
38776-3	



Andere Eloxalfarben siehe Abschnitt 6. Lieferzeit 14 Tage / other anodized colours see section 6. delivery time 14 days

Profi-Pack à 10 Stück im Bund			
professional packing à 10 pcs.			
Farbe / colour	L / l (m)	Art. / ref.	€ / Stk. / pcs.

SB-Pack VE 20 Stk.	
self-service pack à 20 pcs.	
Art. / ref.	€ / Stk. / pcs.

89 Winkelprofil 10 x 24,5 mm. Aluminium eloxiert, selbstklebend

angle edge 10 x 24,5 mm. aluminium anodized, self-adhesive

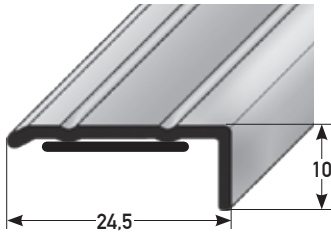

silberfarbig silver	1.0	04503-8	
	2.7	04533-5	
goldfarbig gold	1.0	04603-5	
	2.7	04633-2	
bronzefarbig hell bronze light	1.0	04703-2	
	2.7	04733-9	
bronzefarbig dunkel bronze dark	1.0	04803-9	
	2.7	04833-6	
gold hell gold light	1.0	70622-9	
	2.7	70624-3	
edelstahlfarb. Feinschliff / fine honed stainless steel coloured	1.0	70626-7	
	2.7	70628-1	
schwarz black	1.0	72032-4	
	2.7	72034-8	

04502-1	
04532-8	
04602-8	
04632-5	
04702-5	
04732-2	
04802-2	
04832-9	
70630-4	
70632-8	
70634-2	
70636-6	
72036-2	
72038-6	

Holzdekorfolie / wood decor			
	Buche beech	1.0	38640-7
Eiche oak	2.7	38650-6	
	1.0	38660-5	
Ahorn maple	2.7	38670-4	
	1.0	38680-3	
Kirschbaum cherry wood	2.7	38690-2	
	1.0	38780-0	
Eiche rustikal rustic oak	2.7	38785-5	
	1.0	38790-9	
	2.7	38795-4	

38641-4	
38651-3	
38661-2	
38671-1	
38681-0	
38691-9	
38781-7	
38786-2	
38791-6	
38796-1	



Andere Eloxalfarben siehe Abschnitt 6, Lieferzeit 14 Tage
other anodized colours see section 6, delivery time 14 days

Profi-Pack à 10 Stück im Bund			
professional packing à 10 pcs.			
Farbe/colour	L/l (m)	Art./ref.	€/Stk./pcs.

SB-Pack incl. Schr./Dübel: VE 20 Stk.	
self-service-pack with screws/dowels; à 20 pcs.	
Art./ref.	€/Stk./pcs.

88 Winkelprofil 18 x 24,5 mm, Aluminium eloxiert, gebohrt

angle edge 18 x 24,5 mm.
aluminium anodized, drilled

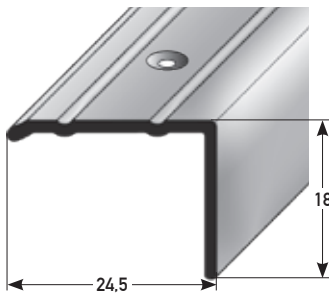

silberfarbig silver	0,8	04080-4	
	0,9	04090-3	
	1,0	04100-9	
	1,2	04110-8	
	2,0	04120-7	
goldfarbig gold	0,8	04180-1	
	0,9	04190-0	
	1,0	04200-6	
	1,2	04210-5	
	2,0	04220-4	
bronzefarbig hell bronze light	0,8	04280-8	
	0,9	04290-7	
	1,0	04300-3	
	1,2	04310-2	
	2,0	04320-1	
bronzefarbig dunkel bronze dark	0,8	04380-5	
	0,9	04390-4	
	1,0	04400-0	
	1,2	04410-9	
	2,0	04420-8	
gold hell gold light	0,8	70640-3	
	0,9	70642-7	
	1,0	70644-1	
	1,2	70646-5	
	2,0	70648-9	
edelstahlfarbig Feinschliff fine-honed stainless steel, coloured	0,8	70652-6	
	0,9	70654-0	
	1,0	70656-4	
	1,2	70658-8	
	2,0	70660-1	
schwarz black	1,0	72040-9	
	2,7	72042-3	

04091-0	
04101-6	
04121-4	
04131-3	
04191-7	
04201-3	
04221-1	
04231-0	
04291-4	
04301-0	
04321-8	
04331-7	
04391-1	
04401-7	
04421-5	
04431-4	
70664-9	
70666-3	
70668-7	
70670-0	
70672-4	
70674-8	
70676-2	
70678-6	
72044-7	
72046-1	

Holzdekorfolie/wood decor	Buche beech	1,0	38520-2	
		2,7	38530-1	
	Eiche oak	1,0	38540-0	
		2,7	38550-9	
	Ahorn maple	1,0	38560-8	
		2,7	38570-7	
	Kirschbaum cherry wood	1,0	38580-6	
		2,7	38585-1	
	Eiche rustikal rustic oak	1,0	38590-5	
		2,7	38595-0	

38521-9	
38531-8	
38541-7	
38551-6	
38561-5	
38571-4	
38581-3	
38586-8	
38591-2	
38596-7	



Andere Eloxalfarben siehe Abschnitt 6. Lieferzeit 14 Tage
other anodized colours see section 6. delivery time 14 days

Profi-Pack à 10 Stück im Bund			
professional packing à 10 pcs.			
Farbe/colour	L/l (m)	Art./ref.	€/Stk./pcs.

SB-Pack VE 20 Stk.	
self-service pack à 20 pcs.	
Art./ref.	€/Stk./pcs.

1

88 Winkelprofil 18 x 24,5 mm. Aluminium eloxiert, selbstklebend

angle edge 18 x 24,5 mm.
aluminium anodized, self-adhesive

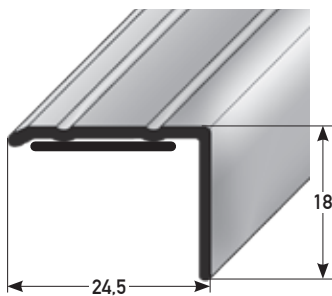

silberfarbig silver	1.0	04103-0	
	2.7	04133-7	
goldfarbig gold	1.0	04203-7	
	2.7	04233-4	
bronzefarbig hell bronze light	1.0	04303-4	
	2.7	04333-1	
bronzefarbig dunkel bronze dark	1.0	04403-1	
	2.7	04433-8	
gold hell gold light	1.0	70682-3	
	2.7	70684-7	
edelstahlfarb. Feinschliff / fine honed stainless steel coloured	1.0	70686-1	
	2.7	70688-5	
schwarz black	1.0	72048-5	
	2.7	72050-8	

04102-3	
04132-0	
04202-0	
04232-7	
04302-7	
04332-4	
04402-4	
04432-1	
70690-8	
70692-2	
70694-6	
70696-0	
72052-2	
72054-6	

Holzdekorfolie/wood decor			
	Buche beech	1.0	38460-1
2.7		38470-0	
Eiche oak	1.0	38480-9	
	2.7	38490-8	
Ahorn maple	1.0	38500-4	
	2.7	38510-3	
Kirschbaum cherry wood	1.0	38600-1	
	2.7	38605-6	
Eiche rustikal rustic oak	1.0	38610-0	
	2.7	38615-5	

38461-8	
38471-7	
38481-6	
38491-5	
38501-1	
38511-0	
38601-8	
38606-3	
38611-7	
38616-2	



Andere Eloxalfarben siehe Abschnitt 6, Lieferzeit 14 Tage
other anodized colours see section 6, delivery time 14 days

Profi-Pack à 10 Stück im Bund			
professional packing à 10 pcs.			
Farbe / colour	L / l (m)	Art. / ref.	€/Stk. / pcs.

SB-Pack incl. Schr. / Dübel: VE 20 Stk.	
self-service-pack with screws / dowels; à 20 pcs.	
Art. / ref.	€/Stk. / pcs.

90 Treppenkante 20 x 20 mm, Aluminium eloxiert, gebohrt

stair nosing 20 x 20 mm, aluminium anodized, drilled

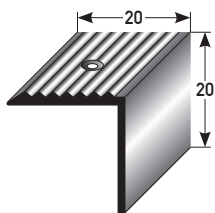

100

silberfarbig silver	1.0	39500-3	
	2.7	39510-2	
goldfarbig gold	1.0	39520-1	
	2.7	39530-0	
bronzefarbig hell bronze light	1.0	39540-9	
	2.7	39550-8	
bronzefarbig dunkel bronze dark	1.0	39560-7	
	2.7	39570-6	

39501-0	
39511-9	
39521-8	
39531-7	
39541-6	
39551-5	
39561-4	
39571-3	

MESSING poliert brass polished	1.0	28733-9	
	2.5	28730-8	

28732-2	
28731-5	

Bitte fordern Sie unsere Pflegehinweise für Messingprofile an!
Please ask for our care tips for brass profiles!

85 Treppenkante 30 x 30 mm, Aluminium eloxiert, gebohrt

stair nosing 30 x 30 mm, aluminium anodized, drilled

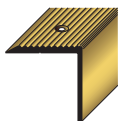
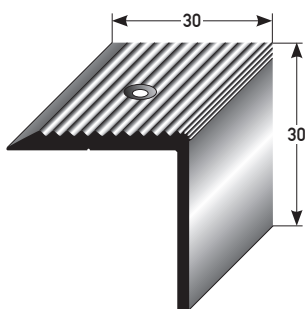

99

silberfarbig silver	0.9	31450-9	
	1.0	31455-4	
	2.7	31460-8	
goldfarbig gold	0.9	31465-3	
	1.0	31470-7	
	2.7	31475-2	
bronzefarbig hell bronze light	0.9	31480-6	
	1.0	31485-1	
	2.7	31490-5	
bronzefarbig dunkel bronze dark	0.9	31495-0	
	1.0	31500-1	
	2.7	31505-6	

31456-1	
31461-5	
31471-4	
31476-9	
31486-8	
31491-2	
31501-8	
31506-3	

MESSING poliert brass polished	1.0	28752-0	
	2.5	28750-6	

28753-7	
28751-3	

Bitte fordern Sie unsere Pflegehinweise für Messingprofile an!
Please ask for our care tips for brass profiles!

Aluminium mit abriebfester Spezialmaillierung, gebohrt / aluminium enameled, hard wearing, drilled

Edelstahl-Emaillebeschichtung
Farbton – dunkelgrau
stainless steel-enameled,
colour – dark grey



1.0	40060-8	
2.0	72848-1	
2.7 *	40070-7 *	

40061-5	
72850-4	
40071-4 *	

Emaillebeschichtung
Farbton – silber metallic
stainless steel-enameled,
colour - silver metallic



1.0	40210-7	
2.0	72852-8	
2.7 *	40211-4 *	

40212-1	
72854-2	
40213-8 *	

Edelstahl-Emaillebeschichtung mit 4 nachleuchtenden Rillen
Farbton – dunkelgrau
stainless steel-enameled
with 4 photoluminescent
grooves, colour – dark grey



1.0	40065-3	
2.0	72856-6	
2.7 *	40075-2 *	

40067-7	
72858-0	
40077-6 *	

* Auslaufartikel / discontinued item

passende emaillierte Schrauben siehe Abschnitt 12 / suitable enameled screws see section 12



Andere Eloxalfarben siehe Abschnitt 6. Lieferzeit 14 Tage
other anodized colours see section 6. delivery time 14 days

Profi-Pack à 10 Stück im Bund			
professional packing à 10 pcs.			
Farbe / colour	L / l (m)	Art. / ref.	€ / Stk. / pcs.

SB-Pack incl. Schr./Dübel: VE 20 Stk.	
self-service-pack with screws / dowels: à 20 pcs.	
Art. / ref.	€ / Stk. / pcs.

372 Treppenkante 30 x 30 x 2 mm R, Aluminium eloxiert, gebohrt

stair nosing 30 x 30 x 2 mm R, aluminium anodized, drilled

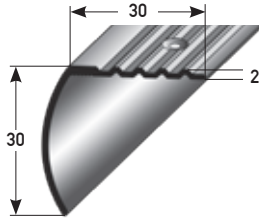

silberfarbig silver	1.0	66200-6	
	2.7	66202-0	
goldfarbig gold	1.0	66204-4	
	2.7	66206-8	
bronzefarbig hell bronze light	1.0	66208-2	
	2.7	66210-5	
bronzefarbig dunkel bronze dark	1.0	66212-9	
	2.7	66214-3	

66216-7	
66218-1	
66220-4	
66222-8	
66224-2	
66226-6	
66228-0	
66230-3	

342 Treppenkante 22 x 30 mm, Aluminium eloxiert, gebohrt

stair nosing 22 x 30 mm, aluminium anodized, drilled

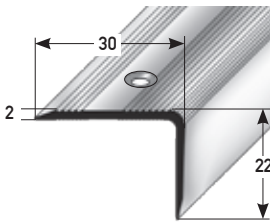

silberfarbig silver	1.0	65540-4	
	2.7	65542-8	
goldfarbig gold	1.0	65544-2	
	2.7	65546-6	
bronzefarbig hell bronze light	1.0	65548-0	
	2.7	65550-3	
bronzefarbig dunkel bronze dark	1.0	65552-7	
	2.7	65554-1	

65560-2	
65562-6	
65564-0	
65566-4	
65568-8	
65570-1	
65572-5	
65574-9	

388 Treppenkante 27 x 27 mm, Aluminium eloxiert, gebohrt

stair nosing 27 x 27 mm, aluminium anodized, drilled

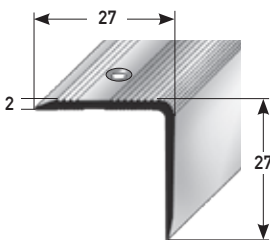

silberfarbig silver	1.0	67196-1	
	2.7	67198-5	
goldfarbig gold	1.0	67200-5	
	2.7	67202-9	
bronzefarbig hell bronze light	1.0	67204-3	
	2.7	67206-7	
bronzefarbig dunkel bronze dark	1.0	67208-1	
	2.7	67210-4	

67216-6	
67218-0	
67220-3	
67222-7	
67224-1	
67226-5	
67228-9	
67230-2	

343 Treppenkante 32 x 30 mm, Aluminium eloxiert, gebohrt

stair nosing 32 x 30 mm, aluminium anodized, drilled

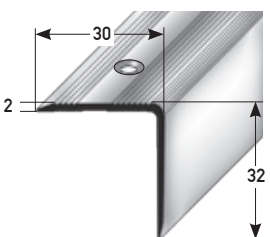

silberfarbig silver	1.0	65582-4	
	2.7	65584-8	
goldfarbig gold	1.0	65586-2	
	2.7	65588-6	
bronzefarbig hell bronze light	1.0	65590-9	
	2.7	65592-3	
bronzefarbig dunkel bronze dark	1.0	65594-7	
	2.7	65596-1	

65602-9	
65604-3	
65606-7	
65608-1	
65610-4	
65612-8	
65614-2	
65616-6	



Andere Eloxalfarben siehe Abschnitt 6, Lieferzeit 14 Tage
other anodized colours see section 6, delivery time 14 days

Profi-Pack à 10 Stück im Bund			
professional packing à 10 pcs.			
Farbe / colour	L / l (m)	Art. / ref.	€/Stk. / pcs.

SB-Pack incl. Schr. / Dübel: VE 20 Stk.	
self-service-pack with screws / dowels; à 20 pcs.	
Art. / ref.	€/Stk. / pcs.

344 Treppenkante 42 x 30 mm, Aluminium eloxiert, gebohrt

stair nosing 42 x 30 mm, aluminium anodized, drilled

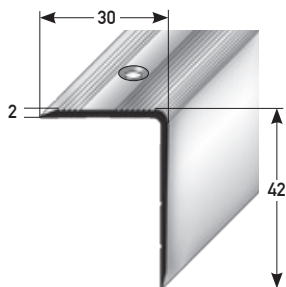

silberfarbig silver	1.0	65624-1	
	2.7	65626-5	
goldfarbig gold	1.0	65628-9	
	2.7	65630-2	
bronzefarbig hell bronze light	1.0	65632-6	
	2.7	65634-0	
bronzefarbig dunkel bronze dark	1.0	65636-4	
	2.7	65638-8	

65644-9	
65646-3	
65648-7	
65650-0	
65652-4	
65654-8	
65656-2	
65658-6	

389 Treppenkante 42 x 40 mm, Aluminium eloxiert, gebohrt

stair nosing 42 x 40 mm, aluminium anodized, drilled

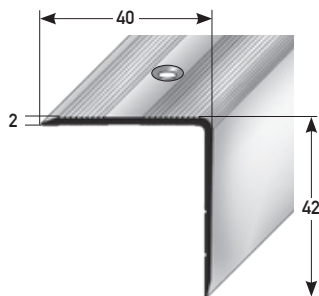

silberfarbig silver	1.0	67152-7	
	2.7	67154-1	
goldfarbig gold	1.0	67156-5	
	2.7	67158-9	
bronzefarbig hell bronze light	1.0	67160-2	
	2.7	67162-6	
bronzefarbig dunkel bronze dark	1.0	67164-0	
	2.7	67166-4	

67172-5	
67174-9	
67176-3	
67178-7	
67180-0	
67182-4	
67184-8	
67186-2	

345 Treppenkante 52 x 30 mm, Aluminium eloxiert, gebohrt

stair nosing 52 x 30 mm, aluminium anodized, drilled

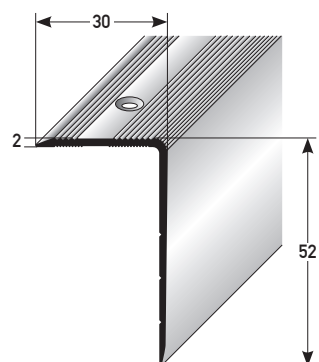

silberfarbig silver	1.0	65666-1	
	2.7	65668-5	
goldfarbig gold	1.0	65670-8	
	2.7	65672-2	
bronzefarbig hell bronze light	1.0	65674-6	
	2.7	65676-0	
bronzefarbig dunkel bronze dark	1.0	65678-4	
	2.7	65680-7	

65686-9	
65688-3	
65690-6	
65692-0	
65694-4	
65696-8	
65698-2	
65700-2	



1. WINKELPROFILE UND TREPPENKANTEN AUS ALUMINIUM UND MESSING / 1. ANGLE EDGES+STAIR NOSINGS OUT OF ALUMINIUM +BRASS

Andere Eloxalfarben siehe Abschnitt 6. Lieferzeit 14 Tage
other anodized colours see section 6. delivery time 14 days

Profi-Pack à 10 Stück im Bund			
professional packing à 10 pcs.			
Farbe / colour	L / l (m)	Art. / ref.	€ / Stk. / pcs.

SB-Pack incl. Schr. / Dübel: VE 20 Stk.	
self-service-pack with screws / dowels: à 20 pcs.	
Art. / ref.	€ / Stk. / pcs.

95 Treppenkante 15 x 40 mm. Aluminium eloxiert, gebohrt

stair nosing 15 x 40 mm.
aluminium anodized, drilled

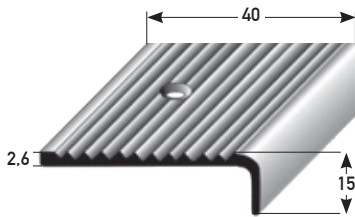

silberfarbig silver	1.0	41100-0	
	2.7	41110-9	
goldfarbig gold	1.0	41120-8	
	2.7	41130-7	
bronzefarbig hell bronze light	1.0	41140-6	
	2.7	41150-5	
bronzefarbig dunkel bronze dark	1.0	41160-4	
	2.7	41170-3	
Aluminium blank aluminium plain	1.0	41180-2	
	2.7	41190-1	

41105-5	
41115-4	
41125-3	
41135-2	
41145-1	
41155-0	
41165-9	
41175-8	
41185-7	
41195-6	

87 Treppenkante 23 x 40 mm. Aluminium eloxiert, gebohrt

stair nosing 23 x 40 mm.
aluminium anodized, drilled

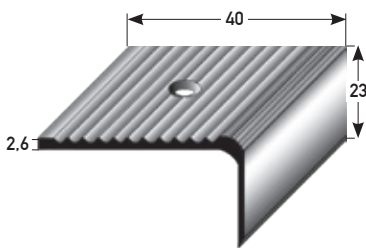

silberfarbig silver	0.9	29430-6	
	1.0	29435-1	
	2.7	29440-5	
goldfarbig gold	0.9	29445-0	
	1.0	29450-4	
	2.7	29455-9	
bronzefarbig hell bronze light	0.9	29460-3	
	1.0	29465-8	
	2.7	29470-2	
bronzefarbig dunkel bronze dark	0.9	29475-7	
	1.0	29480-1	
	2.7	29485-6	

29436-8	
29441-2	
29451-1	
29456-6	
29466-5	
29471-9	
29481-8	
29486-3	

Aluminium mit abriebfester Spezialmaillierung, gebohrt / aluminium enameled, hard wearing, drilled

Edelstahl-Emaillbeschichtung
Farbton – dunkelgrau
stainless steel-enameled,
colour – dark grey

NEU!	1.0	40080-6	
	2.0	72836-8	
	2.7 *	40090-5 *	

40081-3	
72838-2	
40091-2 *	

Emaillbeschichtung
Farbton – silber metallic
stainless steel-enameled,
colour – silver metallic

NEU!	1.0	40230-5	
	2.0	72840-5	
	2.7 *	40231-2 *	

40232-9	
72842-9	
40233-6 *	

Edelstahl-Emaillbeschichtung mit 5 nachleuchtenden Rillen
Farbton – dunkelgrau
stainless steel-enameled
with 5 photoluminescent grooves,
colour – dark grey

NEU!	1.0	40085-1	
	2.0	72844-3	
	2.7 *	40095-0 *	

40087-5	
72846-7	
40097-4 *	

* Auslaufartikel / discontinued item

passende emaillierte Schrauben siehe Abschnitt 12
suitable enameled screws see section 12



Andere Eloxalfarben siehe Abschnitt 6, Lieferzeit 14 Tage
 other anodized colours see section 6, delivery time 14 days

* Auslaufartikel/discontinued item

Profi-Pack à 10 Stück im Bund			
professional packing à 10 pcs.			
Farbe/colour	L/l (m)	Art./ref.	€/Stk./pcs.

SB-Pack incl. Schr./Dübel: VE 20 Stk.	
self-service-pack with screws/dowels; à 20 pcs.	
Art./ref.	€/Stk./pcs.

91 Treppenkante 20 x 40 mm, Aluminium eloxiert, gebohrt

stair nosing 20 x 40 mm,
 aluminium anodized, drilled

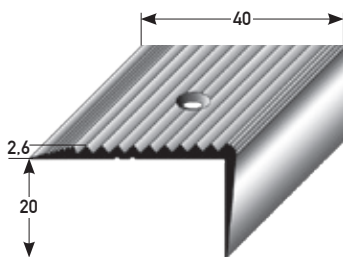

Bitte fordern Sie unsere Pflegehinweise für Messingprofile an!
 Please ask for our care tips for brass profiles!

silberfarbig silver	0,8	07080-1	
	0,9	07090-0	
	1,0	07100-6	
	1,2	07110-5	
	2,0	07120-4	
goldfarbig gold	0,8	07180-8	
	0,9	07190-7	
	1,0	07200-3	
	1,2	07210-2	
	2,0	07220-1	
bronzefarbig hell bronze light	0,8	07280-5	
	0,9	07290-4	
	1,0	07300-0	
	1,2	07310-9	
	2,0	07320-8	
bronzefarbig dunkel bronze dark	0,8	07380-2	
	0,9	07390-1	
	1,0	07400-7	
	1,2	07410-6	
	2,0	07420-5	
	2,7	07430-4	

	07091-7	
	07101-3	
	07111-2	
	07121-1	
	07131-0	
	07191-4	
	07201-0	
	07211-9	
	07221-8	
	07231-7	
	07291-1	
	07301-7	
	07311-6	
	07321-5	
	07331-4	
	07391-8	
	07401-4	
	07411-3	
	07421-2	
	07431-1	



97 MESSING poliert brass polished	1,0	28722-3	
	2,5	28720-9	

	28723-0	
	28721-6	



Beispiel:

Treppenkante mit abriebfester und nachleuchtender Spezialmaillierung (91) für bodennahe Leitsysteme nach BGR 216. Leuchtzeit: 1 Stunde stark bei einer Mindestbeleuchtung von 100 Lux für ca. 5 Min. (siehe nächste Seite)

example: stair nosing with abrasion-resistant and special luminescent enamel (91) for floor-level guidance systems according to BGR 216. Lighting time: 1 hour strong with a minimum illumination of 100 lux for approx. 5 min. (see next page)



Profi-Pack à 10 Stück im Bund

professional packing à 10 pcs.

Farbe / colour	L / l (m)	Art. / ref.	€/Stk. / pcs.
----------------	-----------	-------------	---------------

SB-Pack incl. Schr. / Dübel:
VE 20 Stk.

self-service-pack with
screws / dowels: à 20 pcs.

Art. / ref.	€/Stk. / pcs.
-------------	---------------

Treppenkante 20 x 40 mm, Aluminium mit abriebfester Spezialmaillierung, gebohrt

stair nosing 20 x 40 mm, aluminium
hard wearing enamel, drilled

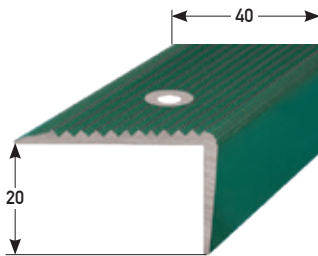

dunkelgrau dark grey	NEU!	1.0	40000-4
		2.0	72796-5
		2.7 *	40010-3 *
silber metallic silver metallic	NEU!	1.0	40150-6
		2.0	72800-9
		2.7 *	40151-3 *
gold gold		1.0 *	64000-4 *
		2.7 *	64002-8 *
blau blue	NEU!	1.0	64004-2
		2.0	72804-7
rot red		1.0 *	64008-0 *
		2.7 *	64010-3 *
grün green	NEU!	1.0	64012-7
		2.0	72808-5
		2.7 *	64014-1 *
schwarz black	NEU!	1.0	64016-5
		2.0	72812-2
		2.7 *	64018-9 *

40001-1	
72798-9	
40011-0 *	
40152-0	
72802-3	
40153-7 *	
64022-6 *	
64024-0 *	
64026-4	
72806-1	
64028-8 *	
64030-1 *	
64032-5 *	
64034-9	
72810-8	
64036-3 *	
64038-7	
72814-6	
64040-0 *	

* Auslaufartikel / discontinued item

Treppenkante 20 x 40 mm, Aluminium mit abriebfester Spezialmaillierung, 5 Rillen nachleuchtend, gebohrt

stair nosing 20 x 40 mm aluminium
hard wearing enamel, drilled,
5 photoluminescent grooves

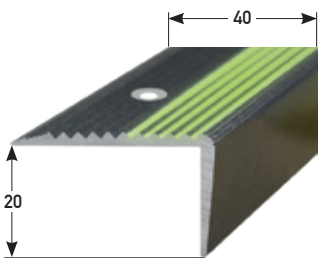

dunkelgrau dark grey	NEU!	1.0	40005-9
		2.0	72816-0
		2.7 *	40015-8 *
silber metallic silver metallic	NEU!	1.0	40140-7
		2.0	72820-7
		2.7 *	40142-1 *
gold gold		1.0 *	64044-8 *
		2.7 *	64046-2 *
blau blue	NEU!	1.0	64048-6
		2.0	72824-5
rot red		1.0	64052-3 *
		2.7	64054-7 *
grün green	NEU!	1.0	64056-1
		2.0	72828-3
		2.7 *	64058-5 *
schwarz black	NEU!	1.0	64060-8
		2.0	72832-0
		2.7 *	64062-2 *

40007-3	
72818-4	
40017-2 *	
40144-5	
72822-1	
40146-9 *	
64066-0 *	
64068-4 *	
64070-7	
72826-9	
64072-1 *	
64074-5 *	
64076-9 *	
64078-3	
72830-6	
64080-6 *	
64082-0	
72834-4	
64084-4 *	

* Auslaufartikel / discontinued item



Andere Eloxalfarben siehe Abschnitt 6, Lieferzeit 14 Tage
other anodized colours see section 6, delivery time 14 days

Profi-Pack à 10 Stück im Bund			
professional packing à 10 pcs.			
Farbe / colour	L / l (m)	Art. / ref.	€/Stk. / pcs.

SB-Pack incl. Schr. / Dübel: VE 20 Stk.	
self-service-pack with screws / dowels; à 20 pcs.	
Art. / ref.	€/Stk. / pcs.

84 Treppenkante 28 x 50 mm, Aluminium eloxiert, gebohrt

stair nosing 28 x 50 mm, aluminium anodized, drilled

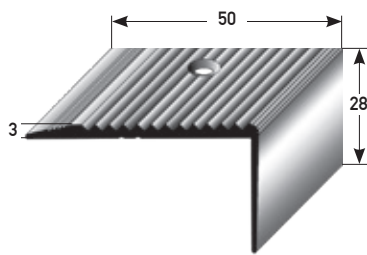

silberfarbig silver	1.0	31410-3	
	2.7	31415-8	
goldfarbig gold	1.0	31420-2	
	2.7	31425-7	
bronzefarbig hell bronze light	1.0	31430-1	
	2.7	31435-6	
bronzefarbig dunkel bronze dark	1.0	31440-0	
	2.7	31445-5	

31416-5	
31426-4	
31436-3	
31446-2	

Aluminium mit abriebfester Spezialmaillierung, gebohrt / aluminium enameled, hard wearing, drilled

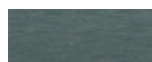

Edelstahl-Emaillbeschichtung
Farbton – dunkelgrau
stainless steel-enameled, colour – dark grey

NEU!	1.0	40040-0	
	2.0	72772-9	
	2.7 *	40050-9 *	

40041-7	
72774-3	
40051-6 *	



Emaillbeschichtung
Farbton – silber metallic
stainless steel-enameled, colour - silver metallic

NEU!	1.0	40190-2	
	2.0	72776-7	
	2.7 *	40191-9 *	

40192-6	
72778-1	
40193-3 *	

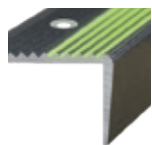

Edelstahl-Emaillbeschichtung mit 5 nachleuchtenden Rillen
Farbton – dunkelgrau
stainless steel-enameled with 5 photoluminescent grooves, colour – dark grey

NEU!	1.0	40045-5	
	2.0	72780-4	
	2.7 *	40055-4 *	

40047-9	
72782-8	
40057-8 *	

* Auslaufartikel / discontinued item

passende emaillierte Schrauben siehe Abschnitt 12 / suitable enameled screws see section 12

83 Treppenkante 42 x 50 mm, Aluminium eloxiert, gebohrt

stair nosing 42 x 50 mm, aluminium anodized, drilled

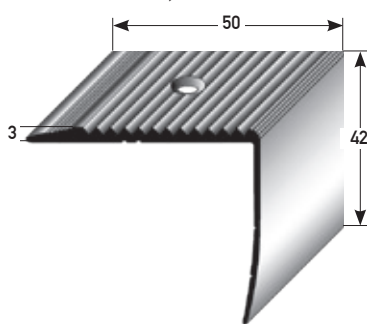

silberfarbig silver	1.0	07621-6	
	2.5	07620-9	
goldfarbig gold	1.0	07641-4	
	2.5	07640-7	
bronzefarbig hell bronze light	1.0	07661-2	
	2.5	07660-5	
bronzefarbig dunkel bronze dark	1.0	07681-0	
	2.5	07680-3	

07622-3	
07642-1	
07662-9	
07682-7	

Aluminium mit abriebfester Spezialmaillierung, gebohrt / aluminium enameled, hard wearing, drilled



Edelstahl-Emaillbeschichtung
Farbton – dunkelgrau
stainless steel-enameled, colour – dark grey

NEU!	1.0	40020-2	
	2.0	72784-2	
	2.5 *	40030-1 *	

40021-9	
72786-6	
40031-8 *	



Emaillbeschichtung
Farbton – silber metallic
stainless steel-enameled, colour - silver metallic

NEU!	1.0	40170-4	
	2.0	72788-0	
	2.5 *	40171-1 *	

40172-8	
72790-3	
40173-5 *	



Edelstahl-Emaillbeschichtung mit 5 nachleuchtenden Rillen
Farbton – dunkelgrau
stainless steel-enameled with 5 photoluminescent grooves, colour – dark grey

NEU!	1.0	40025-7	
	2.0	72792-7	
	2.5 *	40035-6 *	

40027-1	
72794-1	
40037-0 *	

* Auslaufartikel / discontinued item

passende emaillierte Schrauben siehe Abschnitt 12 / suitable enameled screws see section 12



Andere Eloxalfarben siehe Abschnitt 6. Lieferzeit 14 Tage
other anodized colours see section 6. delivery time 14 days

Profi-Pack à 5 Stück im Bund			
professional packing à 5 pcs.			
Farbe / colour	L / l (m)	Art. / ref.	€ / Stk. / pcs.

339 Treppenkante 55 x 69 mm, Aluminium eloxiert, gebohrt

stair nosing 55 x 69 mm.
aluminium anodized, drilled

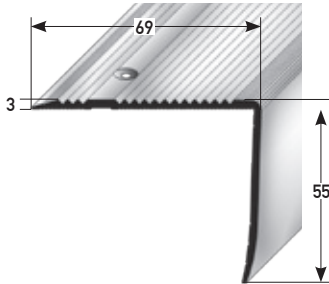

silberfarbig silver	1.0	65504-6	
	2.7	65506-0	
goldfarbig gold	1.0	65508-4	
	2.7	65510-7	
bronzefarbig hell bronze light	1.0	65512-1	
	2.7	65514-5	
bronzefarbig dunkel bronze dark	1.0	65516-9	
	2.7	65518-3	

passende Schrauben siehe Abschnitt 12
suitable enameled screws see section 12

Profi-Pack à 10 Stück im Bund			
professional packing à 10 pcs.			
Material + Farbe / material + colour	L / l (m)	Art. / ref.	€ / Stk. / pcs.

SB-Pack incl. Schr. / Dübel; VE 20 Stk.	
self-service-pack with screws / dowels; à 20 pcs.	
Art. / ref.	€ / Stk. / pcs.

127 Vorstoßprofil 2 x 25 mm, gebohrt

edge profile 2 x 25 mm, drilled

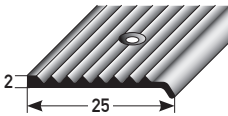

Bitte fordern Sie unsere Pflegehinweise für Messingprofile an!
Please ask for our care tips for brass profiles!

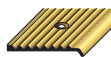

Alu silberfarbig silver	1.0	69960-6	
	2.5	69962-0	
Alu goldfarbig gold	1.0	69964-4	
	2.5	69966-8	
Alu bronze hell bronze light	1.0	69968-2	
	2.5	69970-5	
Alu bronze dunkel bronze dark	1.0	69972-9	
	2.5	69974-3	

69978-1	
69980-4	
69982-8	
69984-2	
69986-6	
69988-0	
69990-3	
69992-7	

MESSING poliert brass polished	1.0	28210-5	
	2.0	28220-4	
	2.5	28200-6	

28211-2	
28201-3	

129 Vorstoßprofil 3 x 30 mm, gebohrt

edge profile 3 x 30 mm, drilled

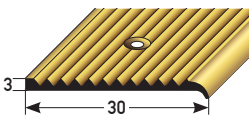

MESSING poliert brass polished	1.0	28630-1	
	2.0	28640-0	
	2.5	28650-9	

28631-8	
28651-6	

Bitte fordern Sie unsere Pflegehinweise für Messingprofile an! Please ask for our care tips for brass profiles!

128 Vorstoßprofil 3 x 35 mm, gebohrt

edge profile 3 x 35 mm, drilled

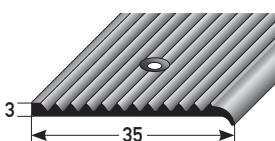

Bitte fordern Sie unsere Pflegehinweise für Messingprofile an!
Please ask for our care tips for brass profiles!



Alu silberfarbig silver	1.0	28530-4	
	2.5	28535-9	
Alu goldfarbig gold	1.0	28540-3	
	2.5	28545-8	
Alu bronze hell bronze light	1.0	28550-2	
	2.5	28555-7	
Alu bronze dunkel bronze dark	1.0	28560-1	
	2.5	28565-6	

28531-1	
28536-6	
28541-0	
28546-5	
28551-9	
28556-4	
28561-8	
28566-3	

MESSING poliert brass polished	1.0	28610-3	
	2.0	28620-2	
	2.5	28600-4	

28611-0	
28601-1	



Andere Eloxalfarben siehe Abschnitt 6, Lieferzeit 14 Tage
other anodized colours see section 6, delivery time 14 days

Profi-Pack à 10 Stück im Bund			
professional packing à 10 pcs.			
Farbe / colour	L / l (m)	Art. / ref.	€ / Stk. / pcs.

SB-Pack incl. Schr. / Dübel: VE 20 Stk.	
self-service-pack with screws / dowels; à 20 pcs.	
Art. / ref.	€ / Stk. / pcs.

474 Fassonprofil 2 mm, Aluminium eloxiert, gebohrt

fasson stair nosing 2 mm, aluminium anodized, drilled

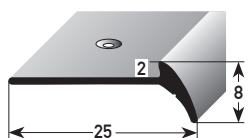

AUSKLINKEN & BIEGEN
notched + bent

silberfarbig silver	1.0	70700-4	
	2.7	70702-8	
goldfarbig gold	1.0	70704-2	
	2.7	70706-6	
bronzefarbig hell bronze light	1.0	70708-0	
	2.7	70710-3	
bronzefarbig dunkel bronze dark	1.0	70712-7	
	2.7	70714-1	

70716-5	
70718-9	
70720-2	
70722-6	
70724-0	
70726-4	
70728-8	
70730-1	

475 Fassonprofil 2.5 mm, Aluminium eloxiert, gebohrt

fasson stair nosing 2.5 mm, aluminium anodized, drilled

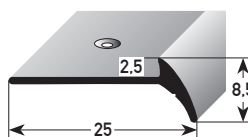

AUSKLINKEN & BIEGEN
notched + bent

silberfarbig silver	1.0	70734-9	
	2.7	70736-3	
goldfarbig gold	1.0	70738-7	
	2.7	70740-0	
bronzefarbig hell bronze light	1.0	70742-4	
	2.7	70744-8	
bronzefarbig dunkel bronze dark	1.0	70746-2	
	2.7	70748-6	

70750-9	
70752-3	
70754-7	
70756-1	
70758-5	
70760-8	
70762-2	
70764-6	

476 Fassonprofil 3 mm, Aluminium eloxiert, gebohrt

fasson stair nosing 3 mm, aluminium anodized, drilled

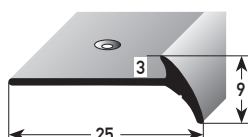

AUSKLINKEN & BIEGEN
notched + bent

silberfarbig silver	1.0	70768-4	
	2.7	70770-7	
goldfarbig gold	1.0	70772-1	
	2.7	70774-5	
bronzefarbig hell bronze light	1.0	70776-9	
	2.7	70778-3	
bronzefarbig dunkel bronze dark	1.0	70780-6	
	2.7	70782-0	

70784-4	
70786-8	
70788-2	
70790-5	
70792-9	
70794-3	
70796-7	
70798-1	

AUSKLINKEN & BIEGEN
notched + bent

Befestigungsschenkel ausklinken
attachment flanges notched

Befestigungsschenkel ausklinken und biegen
attachment flanges notched and bent

Art. / ref.	€ / m
22240-8	

auf Anfrage
on request



1. WINKELPROFILE UND TREPPENKANTEN AUS ALUMINIUM UND MESSING / 1. ANGLE EDGES+STAIR NOSINGS OUT OF ALUMINIUM +BRASS

Andere Eloxalfarben siehe Abschnitt 6. Lieferzeit 14 Tage
other anodized colours see section 6. delivery time 14 days

Profi-Pack à 10 Stück im Bund

professional packing à 10 pcs.

Farbe / colour	L / l (m)	Art. / ref.	€/Stk. / pcs.
----------------	-----------	-------------	---------------

SB-Pack incl. Schr. / Dübel: VE 20 Stk.

self-service-pack with screws / dowels: à 20 pcs.

Art. / ref.	€/Stk. / pcs.
-------------	---------------

435 Treppenkante 10 x 37 x 2 mm, Aluminium eloxiert, gebohrt

stair nosing 10 x 37 x 2 mm, aluminium anodized, drilled

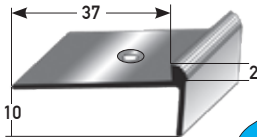

AUSKLINKEN & BIEGEN
notched + bent

silberfarbig silver	1.0	68100-7	
	2.7	68102-1	
goldfarbig gold	1.0	68104-5	
	2.7	68106-9	
bronzefarbig hell bronze light	1.0	68108-3	
	2.7	68110-6	
bronzefarbig dunkel bronze dark	1.0	68112-0	
	2.7	68114-4	

68118-2	
68120-5	
68122-9	
68124-3	
68126-7	
68128-1	
68130-4	
68132-8	

436 Treppenkante 24 x 37 x 2 mm, Aluminium eloxiert, gebohrt

stair nosing 24 x 37 x 2 mm, aluminium anodized, drilled

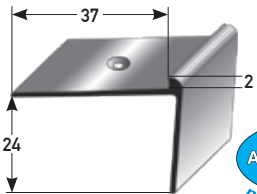

AUSKLINKEN & BIEGEN
notched + bent

silberfarbig silver	1.0	68150-2	
	2.7	68152-6	
goldfarbig gold	1.0	68154-0	
	2.7	68156-4	
bronzefarbig hell bronze light	1.0	68158-8	
	2.7	68160-1	
bronzefarbig dunkel bronze dark	1.0	68162-5	
	2.7	68164-9	

68168-7	
68170-0	
68172-4	
68174-8	
68176-2	
68178-6	
68180-9	
68182-3	

266 Treppenkante 40 x 37 x 2 mm, Aluminium eloxiert, gebohrt

stair nosing 40 x 37 x 2 mm, aluminium anodized, drilled

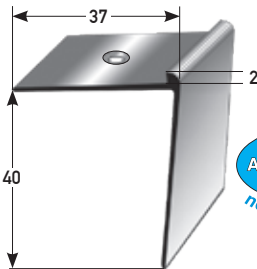

AUSKLINKEN & BIEGEN
notched + bent

silberfarbig silver	1.0	46482-2	
	2.7	46480-8	
goldfarbig gold	1.0	46492-1	
	2.7	46490-7	
bronzefarbig hell bronze light	1.0	46502-7	
	2.7	46500-3	
bronzefarbig dunkel bronze dark	1.0	46512-6	
	2.7	46510-2	

46486-0	
46484-6	
46496-9	
46494-5	
46506-5	
46504-1	
46516-4	
46514-0	

383 Treppenkante 10 x 37 x 2.5 mm, Aluminium eloxiert, gebohrt

stair nosing 10 x 37 x 2.5 mm, aluminium anodized, drilled

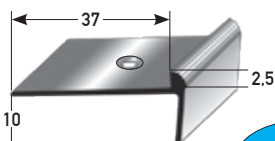

AUSKLINKEN & BIEGEN
notched + bent

silberfarbig silver	1.0	66556-4	
	2.7	66558-8	
goldfarbig gold	1.0	66560-1	
	2.7	66562-5	
bronzefarbig hell bronze light	1.0	66564-9	
	2.7	66566-3	
bronzefarbig dunkel bronze dark	1.0	66568-7	
	2.7	66570-0	

66580-9	
66582-3	
66584-7	
66586-1	
66588-5	
66590-8	
66592-2	
66594-6	

AUSKLINKEN & BIEGEN
notched + bent

Befestigungsschenkel ausklinken
attachment flanges notched

Befestigungsschenkel ausklinken und biegen
attachment flanges notched and bent

Art. / ref.	€/ m
22240-8	

auf Anfrage
on request



Andere Eloxalfarben siehe Abschnitt 6, Lieferzeit 14 Tage
other anodized colours see section 6, delivery time 14 days

Profi-Pack à 10 Stück im Bund			
professional packing à 10 pcs.			
Farbe / colour	L / l (m)	Art. / ref.	€/Stk. / pcs.

SB-Pack incl. Schr. / Dübel: VE 20 Stk.	
self-service-pack with screws / dowels; à 20 pcs.	
Art. / ref.	€/Stk. / pcs.

384 Treppenkante 24 x 37 x 2,5 mm, Aluminium eloxiert, gebohrt

stair nosing 24 x 37 x 2,5 mm, aluminium anodized, drilled

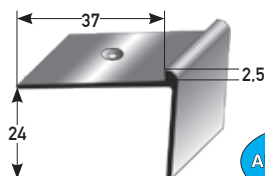

AUSKLINKEN & BIEGEN
notched + bent

silberfarbig silver	1.0	66604-2	
	2.7	66606-6	
goldfarbig gold	1.0	66608-0	
	2.7	66610-3	
bronzefarbig hell bronze light	1.0	66612-7	
	2.7	66614-1	
bronzefarbig dunkel bronze dark	1.0	66616-5	
	2.7	66618-9	

66628-8	
66630-1	
66632-5	
66634-9	
66636-3	
66638-7	
66640-0	
66642-4	

385 Treppenkante 40 x 37 x 2,5 mm, Aluminium eloxiert, gebohrt

stair nosing 40 x 37 x 2,5 mm, aluminium anodized, drilled

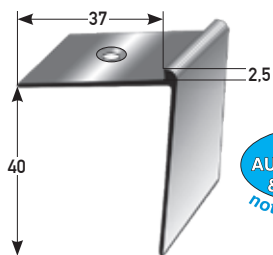

AUSKLINKEN & BIEGEN
notched + bent

silberfarbig silver	1.0	66652-3	
	2.7	66654-7	
goldfarbig gold	1.0	66656-1	
	2.7	66658-5	
bronzefarbig hell bronze light	1.0	66660-8	
	2.7	66662-2	
bronzefarbig dunkel bronze dark	1.0	66664-6	
	2.7	66666-0	

66676-9	
66678-3	
66680-6	
66682-0	
66684-4	
66686-8	
66688-2	
66690-5	

437 Treppenkante 10 x 37 x 3 mm, Aluminium eloxiert, gebohrt

stair nosing 10 x 37 x 3 mm, aluminium anodized, drilled

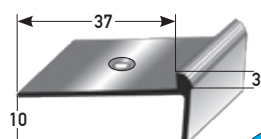

AUSKLINKEN & BIEGEN
notched + bent

silberfarbig silver	1.0	68200-4	
	2.7	68202-8	
goldfarbig gold	1.0	68204-2	
	2.7	68206-6	
bronzefarbig hell bronze light	1.0	68208-0	
	2.7	68210-3	
bronzefarbig dunkel bronze dark	1.0	68212-7	
	2.7	68214-1	

68218-9	
68220-2	
68222-6	
68224-0	
68226-4	
68228-8	
68230-1	
68232-5	

94 Treppenkante 24 x 37 x 3 mm, Aluminium eloxiert, gebohrt

stair nosing 24 x 37 x 3 mm, aluminium anodized, drilled

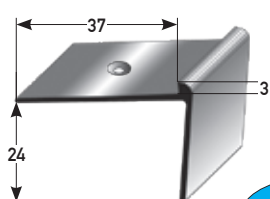

AUSKLINKEN & BIEGEN
notched + bent

silberfarbig silver	1.0	35560-1	
	2.7	35520-5	
goldfarbig gold	1.0	35570-0	
	2.7	35530-4	
bronzefarbig hell bronze light	1.0	35580-9	
	2.7	35540-3	
bronzefarbig dunkel bronze dark	1.0	35590-8	
	2.7	35550-2	

35561-8	
35521-2	
35571-7	
35531-1	
35581-6	
35541-0	
35591-5	
35551-9	

AUSKLINKEN & BIEGEN
notched + bent

Befestigungsschenkel ausklinken attachment flanges notched
Befestigungsschenkel ausklinken und biegen attachment flanges notched and bent

Art. / ref.	€/m
22240-8	
auf Anfrage on request	



Andere Eloxalfarben siehe Abschnitt 6. Lieferzeit 14 Tage
other anodized colours see section 6. delivery time 14 days

Profi-Pack à 10 Stück im Bund			
professional packing à 10 pcs.			
Farbe / colour	L / l (m)	Art. / ref.	€ / Stk. / pcs.

SB-Pack incl. Schr. / Dübel: VE 20 Stk.	
self-service-pack with screws / dowels: à 20 pcs.	
Art. / ref.	€ / Stk. / pcs.

341 Treppenkante 40 x 40 x 3 mm, Aluminium eloxiert, gebohrt

stair nosing 40 x 40 x 3 mm, aluminium anodized, drilled

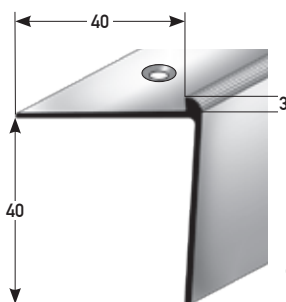

AUSKLINKEN & BIEGEN
notched + bent

silberfarbig silver	1.0	65750-7	
	2.7	65752-1	
goldfarbig gold	1.0	65754-5	
	2.7	65756-9	
bronzefarbig hell bronze light	1.0	65758-3	
	2.7	65760-6	
bronzefarbig dunkel bronze dark	1.0	65762-0	
	2.7	65764-4	

65770-5	
65772-9	
65774-3	
65776-7	
65778-1	
65780-4	
65782-8	
65784-2	

537 Treppenkante 80 x 50 x 3 mm, Aluminium eloxiert, gebohrt

stair nosing 80 x 50 x 3 mm, aluminium anodized, drilled

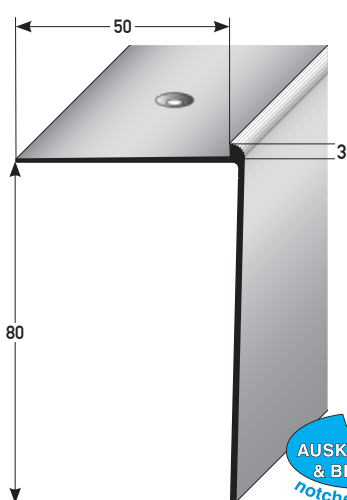

AUSKLINKEN & BIEGEN
notched + bent

silberfarbig silver	1.0	72862-7	
	2.7	72864-1	
goldfarbig gold	1.0	72866-5	
	2.7	72868-9	
bronzefarbig hell bronze light	1.0	72870-2	
	2.7	72872-6	
bronzefarbig dunkel bronze dark	1.0	72874-0	
	2.7	72876-4	

72878-8	
72880-1	
72882-5	
72884-9	
72886-3	
72888-7	
72890-0	
72892-4	



334 Treppenkante 10 x 37 x 5 mm, Aluminium eloxiert, gebohrt

stair nosing 10 x 37 x 5 mm, aluminium anodized, drilled

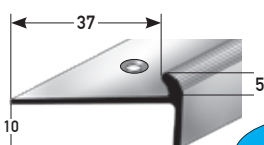

AUSKLINKEN & BIEGEN
notched + bent

silberfarbig silver	1.0	65350-9	
	2.7	65352-3	
goldfarbig gold	1.0	65360-8	
	2.7	65362-2	
bronzefarbig hell bronze light	1.0	65370-7	
	2.7	65372-1	
bronzefarbig dunkel bronze dark	1.0	65380-6	
	2.7	65382-0	

65354-7	
65356-1	
65364-6	
65366-0	
65374-5	
65376-9	
65384-4	
65386-8	

AUSKLINKEN & BIEGEN
notched + bent

Befestigungsschenkel ausklinken
attachment flanges notched

Befestigungsschenkel ausklinken und biegen
attachment flanges notched and bent

Art. / ref.	€ / m
22240-8	

auf Anfrage
on request



Andere Eloxalfarben siehe Abschnitt 6, Lieferzeit 14 Tage
other anodized colours see section 6, delivery time 14 days

Profi-Pack à 10 Stück im Bund			
professional packing à 10 pcs.			
Farbe / colour	L / l (m)	Art. / ref.	€/Stk. / pcs.

SB-Pack incl. Schr. / Dübel: VE 20 Stk.	
self-service-pack with screws / dowels; à 20 pcs.	
Art. / ref.	€/Stk. / pcs.

267 Treppenkante 24 x 37 x 5 mm, Aluminium eloxiert, gebohrt

stair nosing 24 x 37 x 5 mm, aluminium anodized, drilled

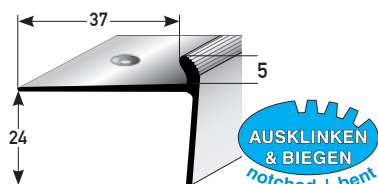

silberfarbig silver	1.0	46522-5	
	2.7	46520-1	
goldfarbig gold	1.0	46532-4	
	2.7	46530-0	
bronzefarbig hell bronze light	1.0	46542-3	
	2.7	46540-9	
bronzefarbig dunkel bronze dark	1.0	46552-2	
	2.7	46550-8	

46526-3	
46524-9	
46536-2	
46534-8	
46546-1	
46544-7	
46556-0	
46554-6	

340 Treppenkante 40 x 40 x 5 mm, Aluminium eloxiert, gebohrt

stair nosing 40 x 40 x 5 mm, aluminium anodized, drilled

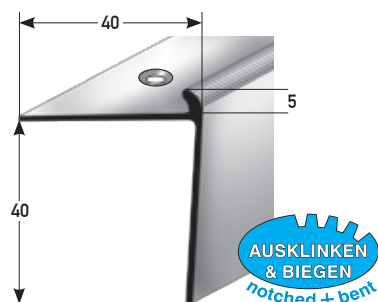

silberfarbig silver	1.0	65708-8	
	2.7	65710-1	
goldfarbig gold	1.0	65712-5	
	2.7	65714-9	
bronzefarbig hell bronze light	1.0	65716-3	
	2.7	65718-7	
bronzefarbig dunkel bronze dark	1.0	65720-0	
	2.7	65722-4	

65728-6	
65730-9	
65732-3	
65734-7	
65736-1	
65738-5	
65740-8	
65742-2	

333 Treppenkante 10 x 37 x 7 mm, Aluminium eloxiert, gebohrt

stair nosing 10 x 37 x 7 mm, aluminium anodized, drilled

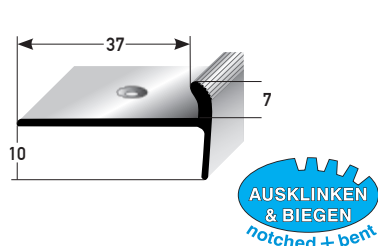

silberfarbig silver	1.0	65300-4	
	2.7	65302-8	
goldfarbig gold	1.0	65310-3	
	2.7	65312-7	
bronzefarbig hell bronze light	1.0	65320-2	
	2.7	65322-6	
bronzefarbig dunkel bronze dark	1.0	65330-1	
	2.7	65332-5	

65304-2	
65306-6	
65314-1	
65316-5	
65324-0	
65326-4	
65334-9	
65336-3	

496 wendbares Treppenseitenprofil 3/5 mm, Aluminium eloxiert, ungebohrt

turnable stair side profile 3/5 mm, aluminium anodized, undrilled

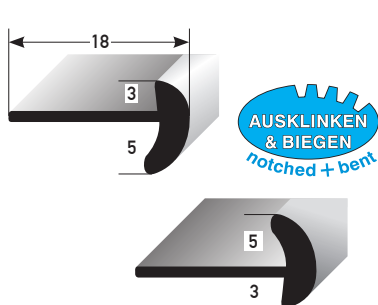

silberfarbig silver	2.7	71330-2	
		71332-6	
		71334-0	
		71336-4	

71338-8	
71340-1	
71342-5	
71344-9	



Befestigungsschenkel ausklinken attachment flanges notched
Befestigungsschenkel ausklinken und biegen attachment flanges notched and bent

Art. / ref.	€/m
22240-8	
auf Anfrage on request	



Andere Eloxalfarben siehe Abschnitt 6. Lieferzeit 14 Tage
other anodized colours see section 6. delivery time 14 days

Treppennenecken aus Aluminium

stair inside corners out of aluminium

Profi-Pack à 10 Stück im Bund			
professional packing à 10 pcs.			
Farbe / colour	L / l (m)	Art. / ref.	€ / Stk. / pcs.

SB-Pack: VE 20 Stk.	
self-service-pack: à 20 pcs.	
Art. / ref.	€ / Stk. / pcs.

369 Treppennenecke 3 mm, Aluminium eloxiert, gebohrt

stair inside corner 3 mm, aluminium anodized, drilled

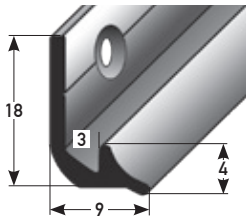

silberfarbig silver	1.0 2.7	66426-0 66428-4	
goldfarbig gold	1.0 2.7	66430-7 66432-1	
bronzefarbig hell bronze light	1.0 2.7	66434-5 66436-9	
bronzefarbig dunkel bronze dark	1.0 2.7	66438-3 66440-6	

66427-7	
66429-1	
66431-4	
66433-8	
66435-2	
66437-6	
66439-0	
66441-3	

370 Treppennenecke 5 mm, Aluminium eloxiert, gebohrt

stair inside corner 5 mm, aluminium anodized, drilled

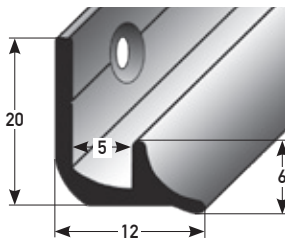

silberfarbig silver	1.0 2.7	66444-4 66446-8	
goldfarbig gold	1.0 2.7	66448-2 66450-5	
bronzefarbig hell bronze light	1.0 2.7	66452-9 66454-3	
bronzefarbig dunkel bronze dark	1.0 2.7	66456-7 66458-1	

66445-1	
66447-5	
66449-9	
66451-2	
66453-6	
66455-0	
66457-4	
66459-8	

Beispiel: Treppennenecke 5 mm, Aluminium eloxiert, gebohrt, siehe oben
example: stair inside corner 5 mm, aluminium anodized, drilled, see above



1

Profi-Pack à 10 Stück im Bund			
professional packing à 10 pcs.			
Farbe / colour	L / l (m)	Art. / ref.	€ / Stk. / pcs.

SB-Pack incl. Schr. / Dübel: VE 20 Stk.	
self-service-pack with screws / dowels; à 20 pcs.	
Art. / ref.	€ / Stk. / pcs.

205 Treppenkante 10 x 30 x 1,2 mm, Messing poliert, profilierte Riffelung, gebohrt

stair nosing 10 x 30 x 1,2 mm, brass polished, fluted profile, drilled

MESSING poliert brass polished	1,0	61850-8	
	2,7	61870-6	

61860-7	
61880-5	

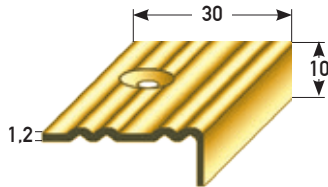

Bitte fordern Sie unsere Pflegehinweise für Messingprofile an!
Please ask for our care tips for brass profiles!

270 Treppenkante 20 x 40 x 1,5 mm, Messing matt, profilierte Riffelung, gebohrt

stair nosing 20 x 40 x 1,5 mm, brass matt, fluted profile, drilled

MESSING matt brass matt	1,0	46600-0	
	2,0	46602-4	

46604-8	
46606-2	

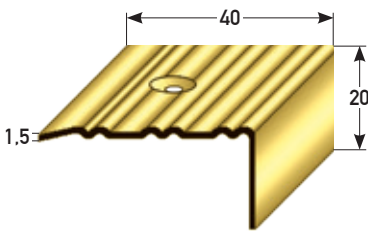

Bitte fordern Sie unsere Pflegehinweise für Messingprofile an!
Please ask for our care tips for brass profiles!

271 Treppenkante 40 x 40 x 1,5 mm, Messing matt, profilierte Riffelung, gebohrt

stair nosing 40 x 40 x 1,5 mm, brass matt, fluted profile, drilled

MESSING matt brass matt	1,0	46610-9	
	2,0	46612-3	

46614-7	
46616-1	

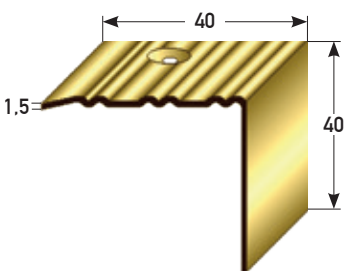

Bitte fordern Sie unsere Pflegehinweise für Messingprofile an!
Please ask for our care tips for brass profiles!

98 Treppenkante 15 x 35 mm, Messing poliert, gebohrt

stair nosing 15 x 35 mm, brass polished, drilled

MESSING poliert brass polished	1,0	28712-4	
	2,5	28710-0	

28713-1	
28711-7	

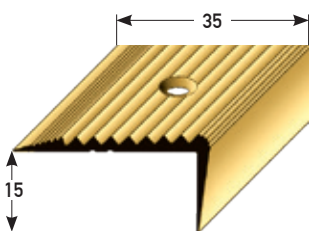

Bitte fordern Sie unsere Pflegehinweise für Messingprofile an!
Please ask for our care tips for brass profiles!



1. WINKELPROFILE UND TREPPENKANTEN AUS ALUMINIUM UND MESSING / 1. ANGLE EDGES+STAIR NOSINGS OUT OF ALUMINIUM +BRASS

Andere Eloxalfarben siehe Abschnitt 6. Lieferzeit 14 Tage
other anodized colours see section 6. delivery time 14 days

Profi-Pack à 10 Stück im Bund			
professional packing à 10 pcs.			
Farbe / colour	L / l (m)	Art. / ref.	€ / Stk. / pcs.

SB-Pack incl. Schr. / Dübel: VE 20 Stk.	
self-service-pack with screws / dowels: à 20 pcs.	
Art. / ref.	€ / Stk. / pcs.

82 Kombi-Treppenkante 23 x 40 mm, Aluminium eloxiert, gebohrt

combination stair nosing 23 x 40 mm, aluminium anodized, drilled

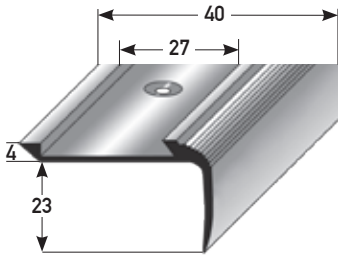

silberfarbig silver	1.0	07501-1	
	2.5	07500-4	
goldfarbig gold	1.0	07521-9	
	2.5	07520-2	
bronzefarbig hell bronze light	1.0	07541-7	
	2.5	07540-0	
bronzefarbig dunkel bronze dark	1.0	07561-5	
	2.5	07560-8	

07502-8	
07522-6	
07542-4	
07562-2	

passend für Einlage 27 mm, siehe Nr. 121, Seite 22
suitable for insert 27 mm, see no. 121, page 22

81 Kombi-Treppenkante 27 x 58 mm, Aluminium eloxiert, gebohrt

combination stair nosing 27 x 58 mm, aluminium anodized, drilled

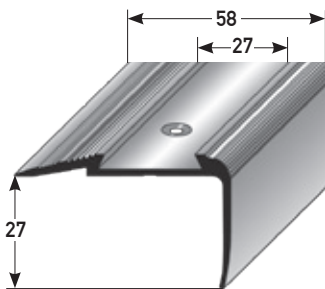

silberfarbig silver	1.0	07941-5	
	2.5	07940-8	
goldfarbig gold	1.0	07951-4	
	2.5	07950-7	
bronzefarbig hell bronze light	1.0	07961-3	
	2.5	07960-6	
bronzefarbig dunkel bronze dark	1.0	07971-2	
	2.5	07970-4	

07942-2	
07952-1	
07962-0	
07972-9	

passend für Einlage 27 mm, siehe Nr. 121, Seite 22
suitable for insert 27 mm, see no. 121, page 22

Aluminium mit abriebfester Spezialmaillierung, gebohrt / aluminium enameled, hard wearing, drilled

Edelstahl-Emaillbeschichtung
Farbton – dunkelgrau
stainless steel-enameled,
colour – dark grey



1.0	40100-1	
2.0	72764-4	
2.5 *	40110-0 *	

40101-8	
72766-8	
40111-7 *	

Emaillbeschichtung
Farbton – silber metallic
stainless steel-enameled,
colour - silver metallic



1.0	40250-3	
2.0	72768-2	
2.5 *	40251-0 *	

40252-7	
72770-5	
40253-4 *	

* Auslaufartikel / discontinued item

147 Kombi-Treppenkante 45 x 58 mm, Aluminium eloxiert, gebohrt

combination stair nosing 45 x 58 mm, aluminium anodized, drilled

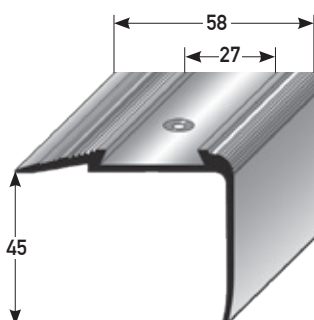

silberfarbig silver	1.0	42700-1	
	2.5	42705-6	
goldfarbig gold	1.0	42715-5	
	2.5	42720-9	
bronzefarbig hell bronze light	1.0	42730-8	
	2.5	42735-3	
bronzefarbig dunkel bronze dark	1.0	42745-2	
	2.5	42750-6	

42710-0	
42725-4	
42740-7	
42755-1	

passend für Einlage 27 mm, siehe Nr. 121, Seite 22
suitable for insert 27 mm, see no. 121, page 22



Andere Eloxalfarben siehe Abschnitt 6, Lieferzeit 14 Tage
other anodized colours see section 6, delivery time 14 days

Profi-Pack à 10 Stück im Bund			
professional packing à 10 pcs.			
Farbe / colour	L / l (m)	Art. / ref.	€ / Stk. / pcs.

SB-Pack incl. Schr. / Dübel: VE 20 Stk.	
self-service-pack with screws / dowels; à 20 pcs.	
Art. / ref.	€ / Stk. / pcs.

146 Kombi-Treppenkante 80 x 58 mm, Aluminium eloxiert, gebohrt

combination stair nosing 80 x 58 mm, aluminium anodized, drilled

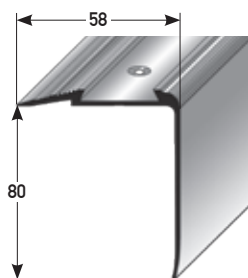

silberfarbig silver	1.0	42760-5	
	2.7	42765-0	
goldfarbig gold	1.0	42775-9	
	2.7	42780-3	
bronzefarbig hell bronze light	1.0	42790-2	
	2.7	42795-7	
bronzefarbig dunkel bronze dark	1.0	42805-3	
	2.7	42810-7	

42770-4	
42785-8	
42800-8	
42815-2	

passend für Einlage 27 mm, siehe Nr. 121, unten
suitable for insert 27 mm, no. 121, see below

Der lange Schenkel kann auch gekürzt werden. / The long side can be shortened on request.



121 PVC-Einlage 27 mm, Weich-PVC

für Kombi-Treppenkante Nr. 81, 82, 146 und 147

PVC-insert 27 mm for combination stair nosing no. 81, 82, 146 + 147 made of soft PVC

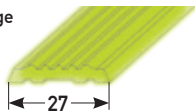
Für Zuschnitte erheben wir einen Arbeitsaufschlag von 15%.
For cuttings we charge a labor surcharge of 15%.



Farbe / colour	L / l (m)	eben / smooth	
grau / grey	25 m	55301-4	
schwarz / black		55302-1	
braun / brown		55303-8	
beige / beige		55304-5	
rot / red		55309-0	
blau / blue	55300-7		
Extrem nachleuchtend extremely photoluminescent	25 m	mit extremer Leuchtkraft with extreme luminosity	

56301-3	
56302-0	
56303-7	
56304-4	
56309-9	
56300-6	
40135-3	

Montagehinweis: Bei der Montage sind die Enden der Einlage mit Montagekleber am Profil zu befestigen.
Installation advice: Fix the ends of the inserts at the profile with installation glue.

92 Treppenkante 15 x 36 mm, Aluminium eloxiert, gebohrt

stair nosing 15 x 36 mm, aluminium anodized, drilled

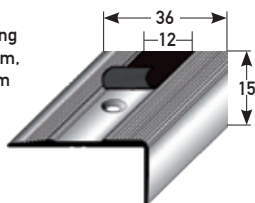

passend für Einlage 12 mm, siehe unten
suitable for insert 12 mm, see below

Profi-Pack à 10 Stück im Bund			
professional packing à 10 pcs.			
Farbe / colour	L / l (m)	Art. / ref.	€ / Stk. / pcs.

SB-Pack incl. Schr. / Dübel: VE 20 Stk.	
self-service-pack with screws / dowels; à 20 pcs.	
Art. / ref.	€ / Stk. / pcs.

silberfarbig silver	1.0	07710-7	
	2.7	07720-6	
goldfarbig gold	1.0	07730-5	
	2.7	07740-4	
bronzefarbig hell bronze light	1.0	07750-3	
	2.7	07760-2	
bronzefarbig dunkel bronze dark	1.0	07770-1	
	2.7	07780-0	

07711-4	
07721-3	
07731-2	
07741-1	
07751-0	
07761-9	
07771-8	
07781-7	

486 Easy-Clean-Einlage 12 mm, rau, selbstklebend, für Treppenkante Nr. 92

easy-clean insert 12 mm, rough, self-adhesive, for stair nosing no. 92

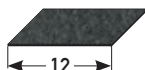

Farbe / colour	L / l (m)	Art. / ref.	€
schwarz / black	Rolle / roll à 25 m	71100-1	
grau / grey		71102-5	
gelb-schwarz yellow-black		71104-9	

Für Zuschnitte erheben wir einen Arbeitsaufschlag von 15%.

For cuttings we charge a labor surcharge of 15%.

Achtung! Verlegeanleitung für Einlagen beachten! Siehe Abschnitt 13.
Attention! Please follow the installation advice in section 13.



1. WINKELPROFILE UND TREPPENKANTEN AUS ALUMINIUM UND MESSING / 1. ANGLE EDGES+STAIR NOSINGS OUT OF ALUMINIUM +BRASS

Andere Eloxalfarben siehe Abschnitt 6. Lieferzeit 14 Tage
other anodized colours see section 6. delivery time 14 days

Profi-Pack à 10 Stück im Bund

professional packing à 10 pcs.

Farbe / colour	L / l (m)	Art. / ref.	€ / Stk. / pcs.
----------------	-----------	-------------	-----------------

SB-Pack incl. Schr. / Dübel: VE 20 Stk.

self-service-pack with screws / dowels: à 20 pcs.

Art. / ref.	€ / Stk. / pcs.
-------------	-----------------

373 Treppenkante 39 x 48 mm, Aluminium eloxiert, gebohrt

stair nosing 39 x 48 mm. aluminium anodized, drilled

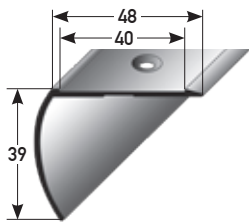

silberfarbig silver	1.0	66362-1	
	2.7	66364-5	
goldfarbig gold	1.0	66368-3	
	2.7	66370-6	
bronzefarbig hell bronze light	1.0	66374-4	
	2.7	66376-8	
bronzefarbig dunkel bronze dark	1.0	66380-5	
	2.7	66382-9	

66366-9	
66372-0	
66378-2	
66384-3	

passend für Einlage 39 mm, Nr. 375 + 487, siehe unten
suitable for insert 39 mm, no. 375 + 487, see below

374 Treppenkante 43 x 50 mm, Aluminium eloxiert, gebohrt

stair nosing 43 x 50 mm. aluminium anodized, drilled

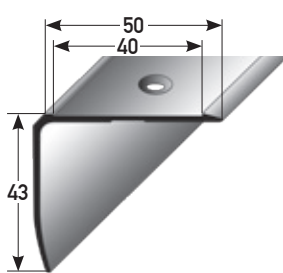

silberfarbig silver	1.0	66388-1	
	2.7	66390-4	
goldfarbig gold	1.0	66394-2	
	2.7	66396-6	
bronzefarbig hell bronze light	1.0	66400-0	
	2.7	66402-4	
bronzefarbig dunkel bronze dark	1.0	66406-2	
	2.7	66408-6	

66392-8	
66398-0	
66404-8	
66410-9	

passend für Einlage 39 mm, Nr. 375 + 487, siehe unten
suitable for insert 39 mm, no. 375 + 487, see below

375 Easy-Clean-Einlage 39 mm, rau, selbstklebend

easy-clean insert, 39 mm rough self-adhesive

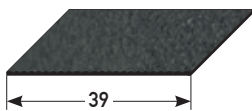

Farbe / colour	L / l (m)	Art. / ref.	€
schwarz / black	Rolle / roll à 25 m	66416-1	
grau / grey		66414-7	
gelb-schwarz yellow-black		66418-5	

487 Anti-Rutsch-Einlage 39 mm, grobe Körnung K60, selbstklebend

anti-slip insert 39 mm coarse grain K60, self-adhesive

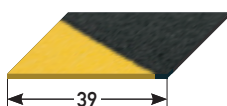

schwarz / black	Rolle / roll à 25 m	71110-0	
grau / grey		71112-4	
braun / brown		71114-8	
gelb-schwarz yellow-black		71116-2	

Für Zuschnitte erheben wir einen Arbeitsaufschlag von 15%. For cuttings we charge a labor surcharge of 15%.

Achtung!! Bitte die Verlegeanleitung für Einlagen beachten! Siehe Abschnitt 13.
Attention!! Please follow the installation advice in section 13.

passend für Übergangsprofil Nr. 412 & Treppenkanten Nr. 373 / 374 / 394 - 396
suitable connecting profile no. 412 + stair nosings no. 373 / 374 / 394 - 396



Andere Eloxalfarben siehe Abschnitt 6, Lieferzeit 14 Tage
other anodized colours see section 6, delivery time 14 days

Profipack, á 10 Stück im Bund			
professional packing, á 10 pcs.			
Farbe / colour	L / l (m)	Art. / ref.	€/Stk. / pcs.

SB-Pack inkl. Schr. / Dübel, VE 20 Stk.	
self-service-pack with screws / dowels; á 20 pcs.	
Art. / ref.	€/Stk. / pcs.

500 Treppenkante 30 x 60 mm, Aluminium eloxiert, gebohrt

stair nosing 30 x 60 mm, aluminium anodized, drilled

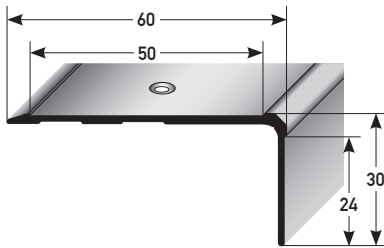

silberfarbig silver	1.0	71534-4		71550-4	
	2.7	71536-8		71552-8	
goldfarbig gold	1.0	71538-2		71554-2	
	2.7	71540-5		71556-6	
bronzefarbig hell bronze light	1.0	71542-9		71558-0	
	2.7	71544-3		71560-3	
bronzef. dunkel bronze dark	1.0	71546-7		71562-7	
	2.7	71548-1		71564-1	

Gemäß DIN 18040-2 „Barrierefreies Bauen“ kann auf der Setzstufe eine 23 mm-Einlage verklebt werden.

According to DIN 18040-2 „barrier-free construction“ a 23 mm insert can be glued on the riser.

passend für 50 mm-Einlage, Nr. 504 + 505, auf Trittstufe und 23 mm-Einlage, Nr. 489 + 490, an Setzstufe, siehe unten und nächste Seite
suitable for tread insert 50 mm, no. 504 + 505, and for riser 23 mm insert, no. 489 + 490, see below and next page

504 Easy-Clean-Einlage 50 mm, rau, selbstklebend

für Treppenkante Nr. 500

easy-clean insert 50 mm, rough, self-adhesive, for stair nosing no. 500

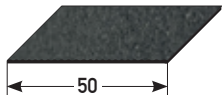

Farbe / colour	L / l (m)	Art. / ref.	€
schwarz / black	Rolle / roll à 25 m	71570-2	
grau / grey		71572-6	
gelb-schwarz yellow-black		71574-0	

Für Zuschnitte erheben wir einen Arbeitsaufschlag von 15%.
For cuttings we charge a labor surcharge of 15%.

Achtung!! Bitte die Verlegeanleitung für Einlagen beachten! Siehe Abschnitt 13.
Attention!! Please follow the installation advice in section 13.

505 Anti-Rutsch-Einlage 50 mm, grobe Körnung K60, selbstklebend

für Treppenkante Nr. 500

anti-slip insert 50 mm, coarse grain K60, self-adhesive, for stair nosing no. 500

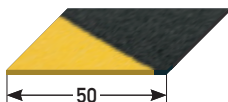

Farbe / colour	L / l (m)	Art. / ref.	€
schwarz / black	Rolle / roll à 25 m	71580-1	
grau / grey		71582-5	
gelb-schwarz yellow-black		71584-9	

Beispiel:
Treppenkante 30 x 60 mm mit Einlage 50 mm gelb-schwarz beklebt, ohne und mit Setzstufenbeklebung mit 23 mm Einlage.

example: stair nosings 30 x 60 mm with 50 mm yellow-black insert, without and with 23 mm insert on the riser.

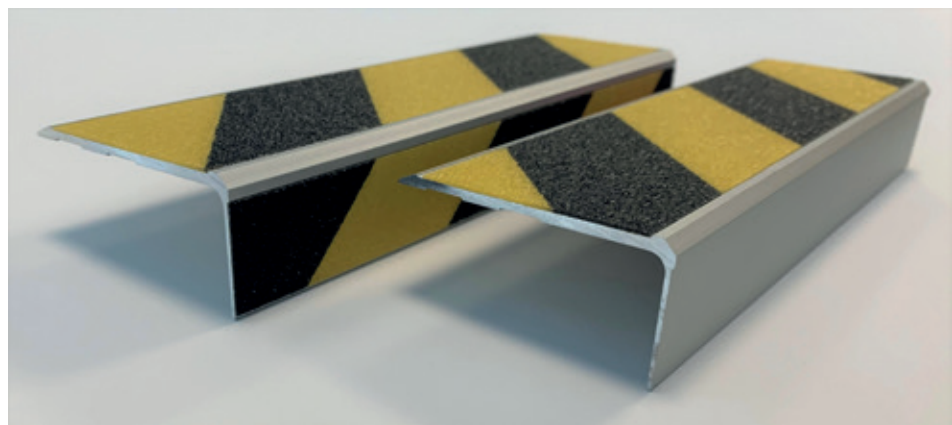

1. WINKELPROFILE UND TREPPENKANTEN AUS ALUMINIUM UND MESSING / 1. ANGLE EDGES+STAIR NOSINGS OUT OF ALUMINIUM +BRASS

Andere Eloxalfarben siehe Abschnitt 6. Lieferzeit 14 Tage
other anodized colours see section 6. delivery time 14 days

Profi-Pack à 10 Stück im Bund

professional packing à 10 pcs.

Farbe / colour	L / l (m)	Art. / ref.	€ / Stk. / pcs.
----------------	-----------	-------------	-----------------

SB-Pack incl. Schr. / Dübel: VE 20 Stk.

self-service-pack with screws / dowels: à 20 pcs.

Art. / ref.	€ / Stk. / pcs.
-------------	-----------------

86 Treppenkante 28,5 x 53 mm. Aluminium eloxiert, gebohrt

stair nosing 28,5 x 53 mm.
aluminium anodized, drilled

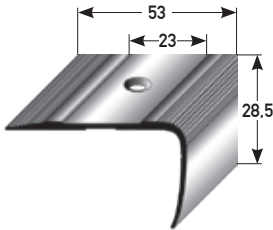

silberfarbig silver	1,0	35440-6	
	2,7	35400-0	
goldfarbig gold	1,0	35450-5	
	2,7	35410-9	
bronzefarbig hellbronze light	1,0	35460-4	
	2,7	35420-8	
bronzefarbig dunkel bronze dark	1,0	35470-3	
	2,7	35430-7	

35401-7	
35411-6	
35421-5	
35431-4	

passend für Einlage 23 mm, Nr. 489 + 490, siehe unten
suitable for insert 23 mm, no. 489 + 490, see below

80 Treppenkante 28,5 x 75 mm. Aluminium eloxiert, gebohrt

stair nosing 28,5 x 75 mm.
aluminium anodized, drilled

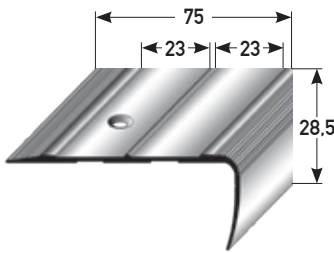

silberfarbig silver	1,0	39660-4	
	2,7	39670-3	
goldfarbig gold	1,0	39680-2	
	2,7	39690-1	
bronzefarbig hell bronze light	1,0	39700-7	
	2,7	39710-6	
bronzefarbig dunkel bronze dark	1,0	39720-5	
	2,7	39730-4	

39671-0	
39691-8	
39711-3	
39731-1	

passend für Einlage 23 mm, Nr. 489 + 490, siehe unten
suitable for insert 23 mm, no. 489 + 490, see below

Achtung: doppelte Menge der Einlage 23 mm berücksichtigen
Attention: Consider double amount of insert

489 Easy-Clean-Einlage 23 mm, rau, selbstklebend

easy-clean insert 23 mm
rough, self-adhesive

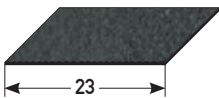

Farbe / colour	L / l (m)	Art. / ref.	€
schwarz / black	Rolle / roll à 25 m	71122-3	
grau / grey		71124-7	
gelb-schwarz yellow-black		71126-1	

Für Zuschnitte erheben wir einen Arbeitsaufschlag von 15 %. For cuttings we charge a labor surcharge of 15%.

Achtung!! Bitte die Verlegeanleitung für Einlagen beachten! Siehe Abschnitt 13.
Attention!! Please follow the installation advice in section 13.

Einlagen für Treppenkanten Nr. 80 / 86 / 500
inserts for stair nosings no. 80 / 86 / 500

490 Anti-Rutsch-Einlage 23 mm, grobe Körnung K60, selbstklebend

anti-slip insert 23 mm
coarse grain K60,
self-adhesive

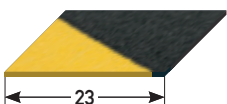

schwarz / black	Rolle / roll à 25 m	71132-2	
grau / grey		71134-6	
braun / brown		71136-0	
gelb-schwarz yellow-black		71138-4	



Andere Eloxalfarben siehe Abschnitt 6, Lieferzeit 14 Tage
other anodized colours see section 6, delivery time 14 days

Profi-Pack à 10 Stück im Bund			
professional packing à 10 pcs.			
Farbe / colour	L / l (m)	Art. / ref.	€/Stk. / pcs.

SB-Pack incl. Schr. / Dübel: VE 20 Stk.	
self-service-pack with screws / dowels; à 20 pcs.	
Art. / ref.	€/Stk. / pcs.

264 Treppenkante 30 x 40 x 2 mm, Aluminium eloxiert, gebohrt

stair nosing 30 x 40 x 2 mm, aluminium anodized, drilled

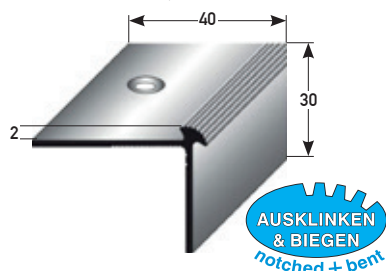

silberfarbig silver	1.0	46560-7	
	2.7	46562-1	
goldfarbig gold	1.0	46570-6	
	2.7	46572-0	
bronzefarbig hell bronze light	1.0	46580-5	
	2.7	46582-9	
bronzefarbig dunkel bronze dark	1.0	46590-4	
	2.7	46592-8	

46564-5	
46566-9	
46574-4	
46576-8	
46584-3	
46586-7	
46594-2	
46596-6	

386 Treppenkante 30 x 40 x 2,5 mm, Aluminium eloxiert, gebohrt

stair nosing 30 x 40 x 2,5 mm, aluminium anodized, drilled

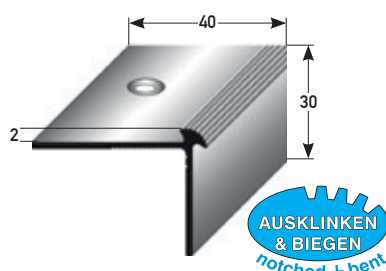

silberfarbig silver	1.0	66700-1	
	2.7	66702-5	
goldfarbig gold	1.0	66704-9	
	2.7	66706-3	
bronzefarbig hell bronze light	1.0	66708-7	
	2.7	66710-0	
bronzefarbig dunkel bronze dark	1.0	66712-4	
	2.7	66714-8	

66724-7	
66726-1	
66728-5	
66730-8	
66732-2	
66734-6	
66736-0	
66738-4	

134 Treppenkante 30 x 40 x 3 mm, Aluminium eloxiert, gebohrt

stair nosing 30 x 40 x 3 mm, aluminium anodized, drilled

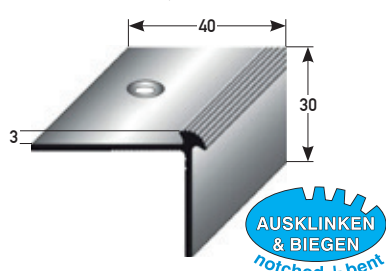

silberfarbig silver	1.0	41340-0	
	2.7	41350-9	
goldfarbig gold	1.0	41360-8	
	2.7	41370-7	
bronzefarbig hell bronze light	1.0	41380-6	
	2.7	41390-5	
bronzefarbig dunkel bronze dark	1.0	41400-1	
	2.7	41410-0	

41341-7	
41351-6	
41361-5	
41371-4	
41381-3	
41391-2	
41401-8	
41411-7	

135 Treppenkante 30 x 40 x 5 mm, Aluminium eloxiert, gebohrt

stair nosing 30 x 40 x 5 mm, aluminium anodized, drilled

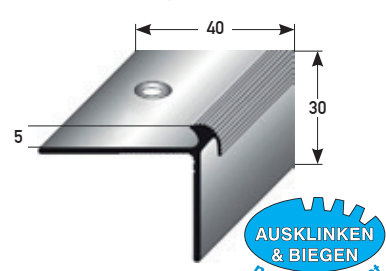

silberfarbig silver	1.0	41260-1	
	2.7	41270-0	
goldfarbig gold	1.0	41280-9	
	2.7	41290-8	
bronzefarbig hell bronze light	1.0	41300-4	
	2.7	41310-3	
bronzefarbig dunkel bronze dark	1.0	41320-2	
	2.7	41330-1	

41261-8	
41271-7	
41281-6	
41291-5	
41301-1	
41311-0	
41321-9	
41331-8	



Befestigungsschenkel ausklinken attachment flanges notched
Befestigungsschenkel ausklinken und biegen attachment flanges notched and bent

Art. / ref.	€/m
22240-8	
auf Anfrage on request	



Andere Eloxalfarben siehe Abschnitt 6. Lieferzeit 14 Tage
other anodized colours see section 6. delivery time 14 days

Profi-Pack à 10 Stück im Bund			
professional packing à 10 pcs.			
Farbe / colour	L/l (m)	Art./ref.	€/Stk./pcs.

SB-Pack incl. Schr. / Dübel: VE 20 Stk.	
self-service-pack with screws / dowels: à 20 pcs.	
Art./ref.	€/Stk./pcs.

519 Eckprofil 30 x 40 x 2 mm, glatt, Aluminium eloxiert, gebohrt

corner profil 30 x 40 x 2 mm, smooth, aluminium anodized, drilled

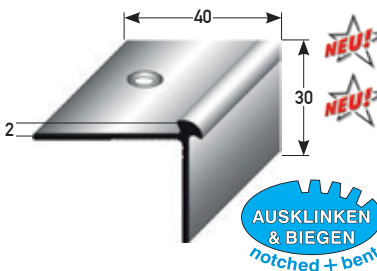

silberfarbig	1.0	71880-2	
silver	2.7	71882-6	
edelstahlfarbig	1.0	72696-8	
stainless steel coloured	2.7	72698-2	
schwarz	1.0	72700-2	
black	2.7	72702-6	

71884-0	
71886-4	
72706-4	
72708-8	
72710-1	
72712-5	

520 Eckprofil 30 x 40 x 2,5 mm, glatt, Aluminium eloxiert, gebohrt

corner profil 30 x 40 x 2,5 mm, smooth, aluminium anodized, drilled

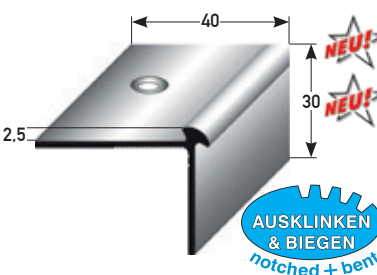

silberfarbig	1.0	71890-1	
silver	2.7	71892-5	
edelstahlfarbig	1.0	72714-9	
stainless steel coloured	2.7	72716-3	
schwarz	1.0	72718-7	
black	2.7	72720-0	

71894-9	
71896-3	
72722-4	
72724-8	
72726-2	
72728-6	

521 Eckprofil 30 x 40 x 3 mm, glatt, Aluminium eloxiert, gebohrt

corner profil 30 x 40 x 3 mm, smooth, aluminium anodized, drilled

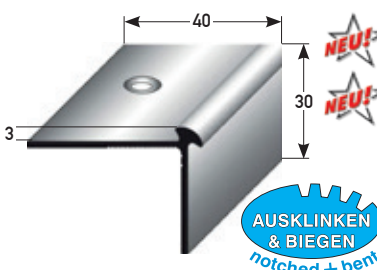

silberfarbig	1.0	71900-7	
silver	2.7	71902-1	
edelstahlfarbig	1.0	72730-9	
stainless steel coloured	2.7	72732-3	
schwarz	1.0	72734-7	
black	2.7	72736-1	

71904-5	
71906-9	
72738-5	
72740-8	
72742-2	
72744-6	

522 Eckprofil 30 x 40 x 5 mm, glatt, Aluminium eloxiert, gebohrt

corner profil 30 x 40 x 5 mm, smooth, aluminium anodized, drilled

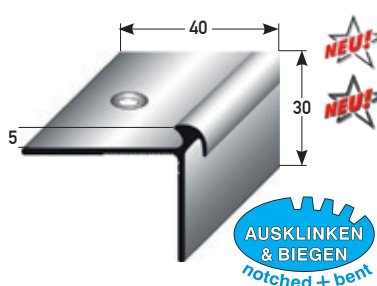

silberfarbig	1.0	71910-6	
silver	2.7	71912-0	
edelstahlfarbig	1.0	72746-0	
stainless steel coloured	2.7	72748-4	
schwarz	1.0	72750-7	
black	2.7	72752-1	

71914-4	
71916-8	
72754-5	
72756-9	
72758-3	
72760-6	



Befestigungsschenkel ausklinken attachment flanges notched
Befestigungsschenkel ausklinken und biegen attachment flanges notched and bent

Art./ref.	€/m
22240-8	
auf Anfrage on request	



Andere Eloxalfarben siehe Abschnitt 6, Lieferzeit 14 Tage
other anodized colours see section 6, delivery time 14 days

Profi-Pack à 10 Stück im Bund			
professional packing à 10 pcs.			
Farbe/colour	L/l (m)	Art./ref.	€/Stk./pcs.

SB-Pack incl. Schr./Dübel: VE 20 Stk.	
self-service-pack with screws/dowels; à 20 pcs.	
Art./ref.	€/Stk./pcs.

491 Treppenkante Doppelseinschub 3 mm, Aluminium eloxiert, 2 x gebohrt

double insert stair nosing
3 mm, aluminium anodized,
2 x drilled

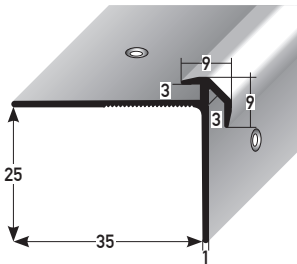

silberfarbig silver	1.0	71144-5	
	2.7	71146-9	
goldfarbig gold	1.0	71148-3	
	2.7	71150-6	
bronzefarbig hell bronze light	1.0	71152-0	
	2.7	71154-4	
bronzefarbig dunkel bronze dark	1.0	71156-8	
	2.7	71158-2	
gold hell gold light	1.0	71160-5	
	2.7	71162-9	
edelstahlfarbig stainless steel coloured	1.0	71164-3	
	2.7	71166-7	

71168-1	
71170-4	
71172-8	
71174-2	
71176-6	
71178-0	
71180-3	
71182-7	
71184-1	
71186-5	
71188-9	
71190-2	

492 Treppenkante Doppelseinschub 5 mm, Aluminium eloxiert, 2 x gebohrt

double insert stair nosing
5 mm, aluminium anodized,
2 x drilled

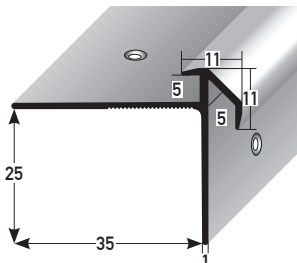

silberfarbig silver	1.0	71196-4	
	2.7	71198-8	
goldfarbig gold	1.0	71200-8	
	2.7	71202-2	
bronzefarbig hell bronze light	1.0	71204-6	
	2.7	71206-0	
bronzefarbig dunkel bronze dark	1.0	71208-4	
	2.7	71210-7	
gold hell gold light	1.0	71212-1	
	2.7	71214-5	
edelstahlfarbig stainless steel coloured	1.0	71216-9	
	2.7	71218-3	

71220-6	
71222-0	
71224-4	
71226-8	
71228-2	
71230-5	
71232-9	
71234-3	
71236-7	
71238-1	
71240-4	
71242-8	

Technische Datenblätter, Verlegehinweise, Materialbeschreibungen
und Pflegehinweise erhalten Sie auf Anfrage oder unter
www.Auer-Metallprofile.de

Technical details, installation tips, material descriptions and care instructions are available on request or under
www.Auer-Metallprofile.de



2. Treppenkanten aus Edelstahl

2. stair nosings out of stainless steel

2

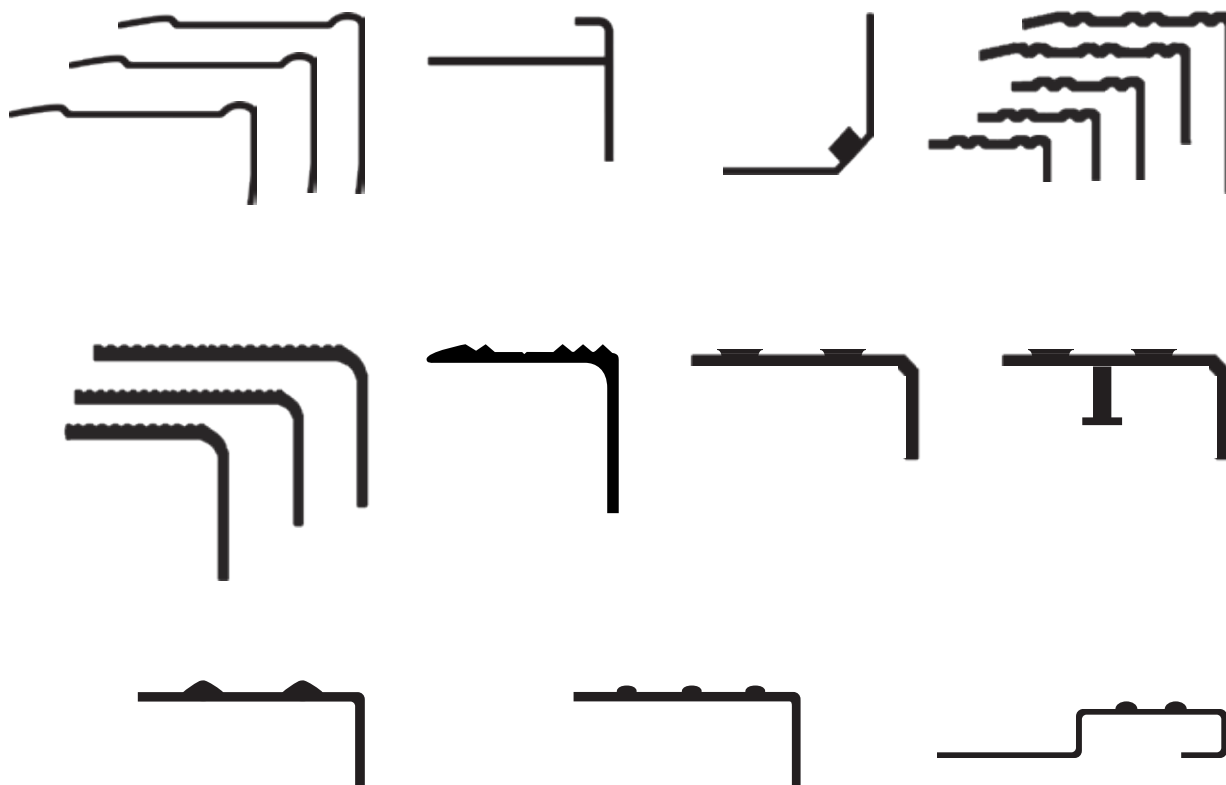

2. TREPPENKANTEN EDELSTAHL / 2. STAIR NOSINGS STAINLESS STEEL

Edelstahlschrauben siehe Abschnitt 12
stainless steel screws see section 12

Edelstahl-Treppenkanten INOX PROTECT zur Verlegung mit Einlage 39 mm			
stainless steel stair nosings for installation with insert 39 mm			
L/l (m)	VE/unit	Art./ref.	€/Stk./pcs.

394 Treppenkante 25 x 63 x 1,5 mm INOX PROTECT, Edelstahl matt, gebohrt

stair nosing 25 x 63 x 1,5 mm
INOX PROTECT, stainless steel matt, drilled

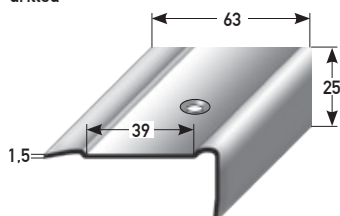

1,0 m	5 Stück/pcs.	67000-1	
2,5 m		67002-5	
3,0 m		67004-9	

für Verlegung mit Einlage 39 mm, siehe Seite 23
for installation with insert 39 mm, see page 23

395 Treppenkante 35 x 63 x 1,5 mm INOX PROTECT, Edelstahl matt, gebohrt

stair nosing 35 x 63 x 1,5 mm
INOX PROTECT, stainless steel matt, drilled

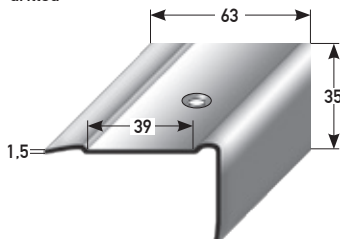

1,0 m	5 Stück/pcs.	67008-7	
2,5 m		67010-0	
3,0 m		67012-4	

für Verlegung mit Einlage 39 mm, siehe Seite 23
for installation with insert 39 mm, see page 23

396 Treppenkante 45 x 63 x 1,5 mm INOX PROTECT, Edelstahl matt, gebohrt

stair nosing 45 x 63 x 1,5 mm
INOX PROTECT, stainless steel matt, drilled

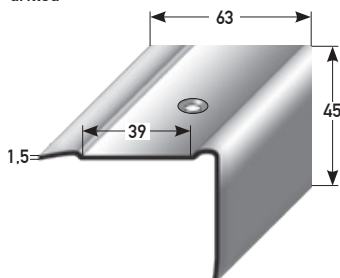

1,0 m	5 Stück/pcs.	67016-2	
2,5 m		67018-6	
3,0 m		67020-9	

für Verlegung mit Einlage 39 mm, siehe Seite 23
for installation with insert 39 mm, see page 23

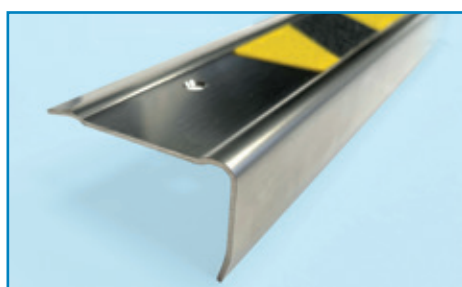

Treppenkante INOX PROTECT mit Einlage 39 mm, gelb-schwarz (siehe oben bzw. Seite 23)
stair nosing INOX PROTECT with insert 39 mm, yellow-black (see above and at page 23)

3.0 m-Ware ist nur per Spedition lieferbar (gesonderte Transportkosten)
3.0 m profiles are only available per forwarding agency (separate transport costs)

Trennscheibe 115 x 1 mm, Inox spezial, zum Trennen von Edelstahlprofilen

cutting disc 115 x 1 mm Inox special, suitable for cutting stainless steel profiles



VE/unit	Art./ref.	€/Stk./pcs.
1 Stück/pcs.	22246-0	

kaum Gratbildung bzw. thermische Blaufärbung
hardly any flashing and no discolouring

Fächerscheibe 115 x 22,2 mm, Körnung 60, zum Entgraten von Edelstahl

flap disc 115 x 22,2 mm, grain size 60, suitable for deburring stainless steel



1 Stück/pcs.	22250-7	
--------------	---------	--



Andere Abmaße auf Anfrage
other dimensions on demand

Edelstahl-Einschubprofile matt gebürstet für Höhen von 2 bis 22 mm

insert profiles out of stainless steel for heights from 2 mm till 22 mm

Koffernr./ case no.	A x B x C x D mm	L / l (m)	VE/unit	Art./ref.	€/Stk./pcs.
------------------------	------------------	-----------	---------	-----------	-------------

Einschubprofile mit Nase, Edelstahl matt, gebohrt

nosed insert profile, stainless steel matt, drilled

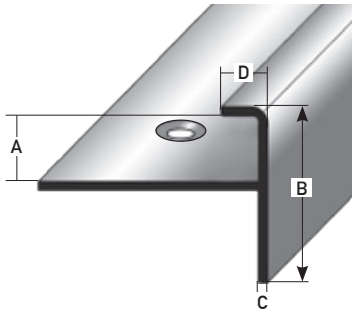

352	2 x 23 x 1,5 x 6	2,7 m	10 Stk./pcs.	60385-6	
353	2,5 x 23 x 1,5 x 6			60395-5	
354	3 x 23 x 1,5 x 6			60405-1	
355	5 x 23 x 1,5 x 6			60416-7	
399	8 x 23 x 1,5 x 6			67662-1	
400	10 x 23 x 1,5 x 6			67668-3	
401	11 x 23 x 1,5 x 6			67674-4	
402	12 x 23 x 1,5 x 6			67680-5	
403	15 x 23 x 1,5 x 6	67686-7			

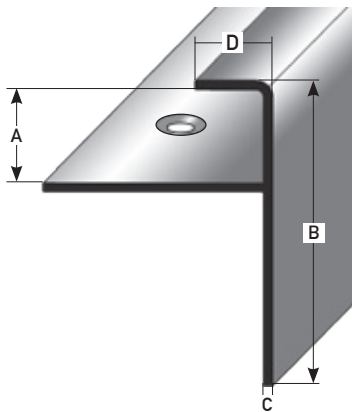

252	2,5 x 40 x 1,5 x 10	2,5 m	10 Stk./pcs.	60380-1	
229	4,5 x 40 x 1,5 x 10			60390-0	
228	8 x 40 x 1,5 x 10			60400-6	
404	11 x 40 x 1,5 x 10			60402-0	
405	12 x 40 x 1,5 x 10			60408-2	
253	15 x 40 x 1,5 x 10			60410-5	
254	22 x 40 x 1,5 x 10			60420-4	

passende Edelstahlschrauben siehe Abschnitt 12/ suitable stainless steel screws see section 12

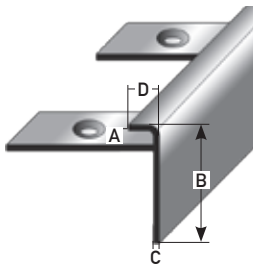

Profil biegen
profile bent

auf Anfrage
on request

Die Fertigung erfolgt auf Fixlängen. Verschnitt wird mit berechnet, ohne Zuschnittskosten.
Production takes place on fixed lengths. blendet is charged with, without calculation of the cost of cutting.



Andere Abmaße auf Anfrage
other dimensions on demand

passende Edelstahlschrauben
siehe Abschnitt 12
suitable stainless steel screws
see section 12

Treppennenecke Edelstahl matt, geböhrt

stair inside corner,
stainless steel matt, drilled

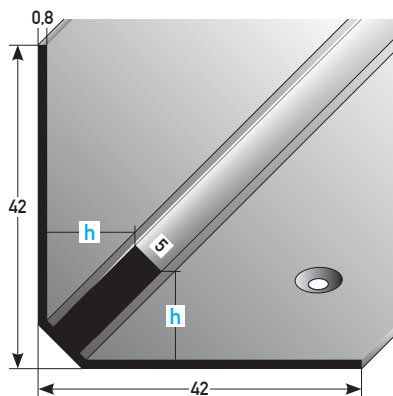
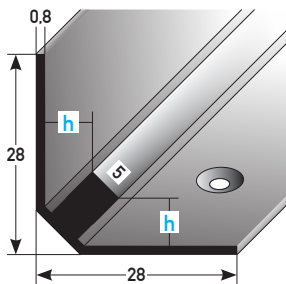
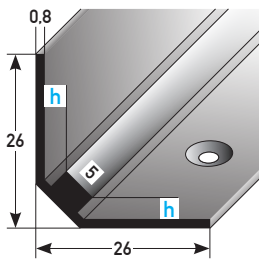

Beispiel: Edelstahl-Einschubprofil mit Nase und Edelstahl-Treppennenecke (siehe oben und vorherige Seite)
example: stainless steel insert profil with nose and stainless steel stair inside corner (see above and previous page)

Edelstahl-Treppennenecken matt gebürstet für Höhen von 2 bis 22 mm

stair inside corner out of stainless steel matt for heights from 2 mm till 22 mm

Koffernr. / case no.	Für Belaghöhe = h in mm / for flooring height = h in mm	L / l (m)	VE/unit	Art./ref.	€/Stk./ pcs.
----------------------	---	-----------	---------	-----------	--------------

367

2 - 3 mm	1.0 m	10 Stk./ pcs.	45621-6	45620-9
	2.7 m			

368

3 - 5 mm	1.0 m	10 Stk./ pcs.	45616-2	45615-5
	2.7 m			

406

8 mm	1.0 m	10 Stk./ pcs.	67612-6	67614-0
	2.7 m			

407

10 mm	1.0 m	10 Stk./ pcs.	67620-1	67622-5
	2.7 m			

408

11 mm	1.0 m	10 Stk./ pcs.	67628-7	67630-0
	2.7 m			

409

12 mm	1.0 m	10 Stk./ pcs.	67636-2	67638-6
	2.7 m			

410

15 mm	1.0 m	10 Stk./ pcs.	67644-7	67646-1
	2.7 m			

411

22 mm	1.0 m	10 Stk./ pcs.	67652-2	67654-6
	2.7 m			

Die Fertigung erfolgt auf Fixlängen. Verschnitt wird mit berechnet, ohne Zuschneidkosten.

Production takes place on fixed lengths, blendet is charged with, without calculation of the cost of cutting.



Rutschhemmungsklasse: R10

Prüfzeugnis kann angefordert werden.
slip resistance class: R10 certificate can be requested.

passende Edelstahlschrauben
siehe Abschnitt 12/ suitable stainless steel screws see section 12

Edelstahl-Treppenkante mit profilierter Riffelung, 1,5 mm Materialdicke

stainless steel stair nosing with fluted raffle, 1,5 mm material thickness

Profi-Pack à 10 Stück im Bund

professional packing à 10 pcs.

L/l (m)	VE/unit	Art./ref.	€/Stk./pcs.
---------	---------	-----------	-------------

SB inkl. Dübel/ Edelstahlschrauben

self-service-pack
with dowels/stainless steel screws

Art./ref.	€/Stk./pcs.
-----------	-------------

154 Edelstahl-Treppenkante 20 x 40 x 1,5 mm, profilierte Riffelung, matt, gebohrt

stainless steel stair nosing 20 x 40 x 1,5 mm,
fluted profile, matt, drilled

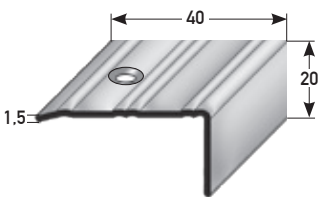

1,0	10 Stk./pcs.	61630-6	
2,7			

61635-1	
61645-0	

R10

201 Edelstahl-Treppenkante 40 x 40 x 1,5 mm, profilierte Riffelung, matt, gebohrt

stainless steel stair nosing 40 x 40 x 1,5 mm,
fluted profile, matt, drilled

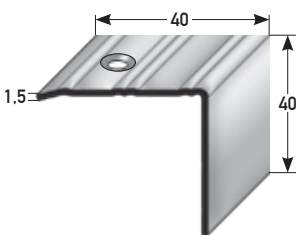

1,0	10 Stk./pcs.	61690-0	
2,7			

61695-5	
61705-1	

R10

202 Edelstahl-Treppenkante 30 x 30 x 1,5 mm, profilierte Riffelung, matt, gebohrt

stainless steel stair nosing 30 x 30 x 1,5 mm,
fluted profile, matt, drilled

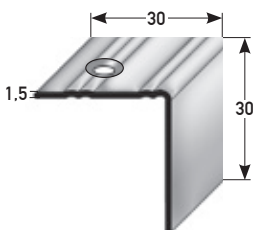

1,0	10 Stk./pcs.	61720-4	
2,7			

61725-9	
61735-8	

R10

203 Edelstahl-Treppenkante 20 x 30 x 1,5 mm, profilierte Riffelung, matt, gebohrt

stainless steel stair nosing 20 x 30 x 1,5 mm,
fluted profile, matt, drilled

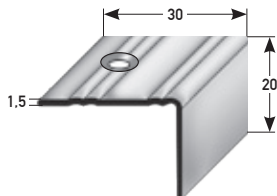

1,0	10 Stk./pcs.	61750-1	
2,7			

61755-6	
61765-5	

R10

204 Edelstahl-Treppenkante 10 x 30 x 1,5 mm, profilierte Riffelung, matt, gebohrt

stainless steel stair nosing 10 x 30 x 1,5 mm,
fluted profile, matt, drilled

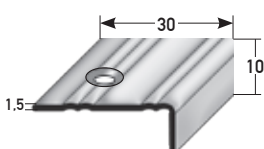

1,0	10 Stk./pcs.	61780-8	
2,7			

61785-3	
61795-2	

R10

ungebohrte Profile & Längen bis 6,0 m auf Anfrage / undrilled profiles and lengths up to 6,0 m on request
Werkstoff 1.4301 (V2A) / V4A auf Anfrage / material 1.4301 (V2A) / V4A on request

Qualität zu wählen ist die beste Art zu sparen / choosing quality is the best way to save



2. TREPPENKANTEN EDELSTAHL / 2. STAIR NOSINGS STAINLESS STEEL

Rutschhemmungsklasse: R10

Prüfzeugnis kann angefordert werden.
slip resistance class: R10 certificate can be requested.

passende Edelstahlschrauben
siehe Abschnitt 12/ suitable stainless steel screws see section 12

Edelstahl-Treppenkante mit gefräster Riffelung –
zum Gegenstoßen von Bodenbelägen oder Beschichtungen bis 3 mm,
rutschhemmende Riffelung, Glattfläche matt gebürstet, gekantet, versenkt gebohrt

stainless steel stair nosing with milled fluting – for installation with floorings up to 3 mm,
antislip fluting, smooth edge matt brushed, edged, countersunk drilled

L/l (m)	VE/unit	Art./ref.	€/Stk./pcs.
---------	---------	-----------	-------------

206 Edelstahl-Treppenkante 20 x 40 x 3 mm, gefräste Riffelung, gekantet, gebohrt

stainless steel stair nosing 20 x 40 x 3 mm,
milled fluting, edged, drilled

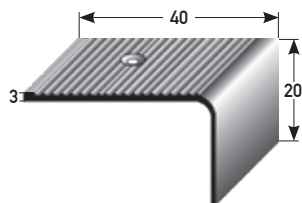

1,0	1 Stk./pcs.	60500-3	
2,5		60501-0	

R10

207 Edelstahl-Treppenkante 30 x 30 x 3 mm, gefräste Riffelung, gekantet, gebohrt

stainless steel stair nosing 30 x 30 x 3 mm,
milled fluting, edged, drilled

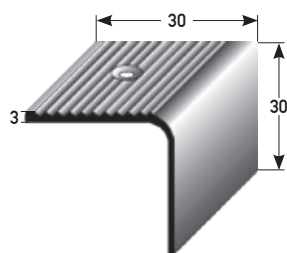

1,0	1 Stk./pcs.	60510-2	
2,5		60511-9	

R10

208 Edelstahl-Treppenkante 28 x 50 x 3 mm, gefräste Riffelung, gekantet, gebohrt

stainless steel stair nosing 28 x 50 x 3 mm,
milled fluting, edged, drilled

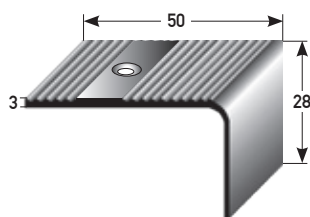

1,0	1 Stk./pcs.	60520-1	
2,5		60521-8	

R10



Kante im Auslauf anphasen
(zum Aufsetzen auf Bodenbelag)
chamfering edges (to be installed on top of flooring)

22213-2

Treppenkante Edelstahl V4A gezogen

drawn stainless steel stair nosing V4A

Profi-Pack à 10 Stück im Bund

SB incl. Dübel/Edelstahlschrauben

L/l (m)	VE/unit	Art./ref.	€/Stk./pcs.	Art./ref.	€/Stk./pcs.
---------	---------	-----------	-------------	-----------	-------------

438 Treppenkante 23 x 25 x 3,5 mm, Edelstahl V4A gezogen, gebohrt

drawn stainless steel stair nosing V4A
23 x 25 x 3,5 mm, drilled

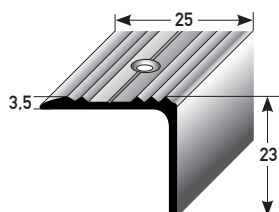

1,0	10 Stück/pcs.	68250-9		68256-1	
2,5		68252-3		68258-5	

Rutschhemmungsklasse: R12

Prüfzeugnis kann angefordert werden.
slip resistance class: R12 certificate can be requested.

3,5er Edelstahlschrauben
siehe Abschnitt 12 / 3,5 stainless steel screws see section 12

311 Treppenkante 10 x 30 x 1,5 mm mit Prägelochung, Edelstahl matt, gebohrt, mit Schutzfolie

stair nosing 10 x 30 x 1,5 mm with embossed punching, stainless steel matt, drilled, with protective film

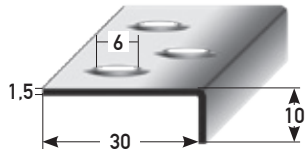

Edelstahl - Treppenkanten mit Prägelochung, matt gebürstet, gebohrt, mit Schutzfolie, VE 1 Stück

stainless steel stair nosings with embossed punching, 1,5 mm material thickness, matt brushed, drilled, with protective film, unit 1 pcs.

Dimension (mm)	L/l (m)	Art./ref.	€/Stk./pcs.
10 x 30 x 1,5	1,0 m	65118-5	
	2,5 m	65120-8	
	3,0 m	65122-2	

R12

312 Treppenkante 20 x 40 x 1,5 mm mit Prägelochung, Edelstahl matt, gebohrt, mit Schutzfolie

stair nosing 20 x 40 x 1,5 mm with embossed punching, stainless steel matt, drilled, with protective film

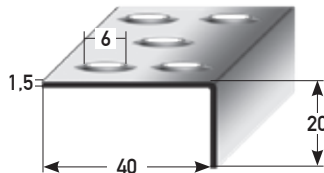

20 x 40 x 1,5	1,0 m	65128-4	
	2,5 m	65130-7	
	3,0 m	65132-1	

R12

318 Treppenkante 25 x 60 x 1,5 mm mit Prägelochung, Edelstahl matt, gebohrt, mit Schutzfolie

stair nosing 25 x 60 x 1,5 mm with embossed punching stainless steel matt, drilled, with protective film

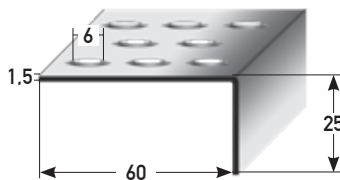

25 x 60 x 1,5	1,0 m	65158-1	
	2,5 m	65160-4	
	3,0 m	65162-8	

R12

319 Treppenkante 25 x 80 x 1,5 mm mit Prägelochung, Edelstahl matt, gebohrt, mit Schutzfolie

stair nosing 25 x 80 x 1,5 mm with embossed punching, stainless steel matt, drilled, with protective film

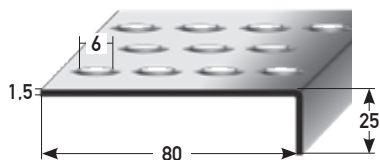

25 x 80 x 1,5	1,0 m	65168-0	
	2,5 m	65170-3	
	3,0 m	65172-7	

R12

320 Treppenkante 50 x 80 x 1,5 mm mit Prägelochung, Edelstahl matt, gebohrt, mit Schutzfolie

stair nosing 50 x 80 x 1,5 mm with embossed punching, stainless steel matt, drilled, with protective film

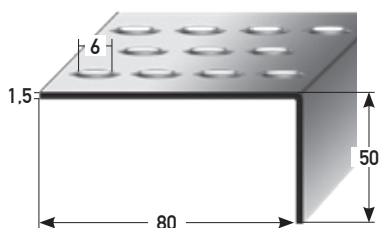

50 x 80 x 1,5	1,0 m	65178-9	
	2,5 m	65180-2	
	3,0 m	65182-6	

R12

Lieferzeit nach vorheriger Absprache
delivery time by prior arrangement

3.0 m-Ware ist nur per Spedition lieferbar (gesonderte Transportkosten)
3,0 m profiles are only available per forwarding agency (separate transport costs)

Rutschhemmungsklasse: R12
 Prüfzeugnis kann angefordert werden.
 slip resistance class: R12 certificate can be requested.

Edelstahl-Treppenkanten mit Prägelochnung und Anker, matt gebürstet, mit Schutzfolie, VE 1 Stück, zum Einbetten in Beton

stainless steel stair nosings with embossed punching and anchor bolt, matt brushed, unit 1 pcs., for embedding in concrete

Dimension (mm)	L/l (m)	Art./ref.	€/Stk./pcs.
10 x 30 x 1,5	1.0 m	65188-8	
	2.5 m	65190-1	
	3.0 m	65192-5	

328 Treppenkante 10 x 30 x 1,5 mm mit Prägelochnung und Anker, Edelstahl matt, gebohrt, mit Schutzfolie

stair nosing 10 x 30 x 1,5 mm with embossed punching + anchor, stainless steel matt, drilled, with protective film

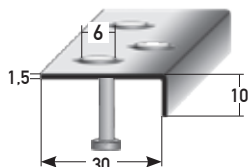

R12

5 Bolzen / Laufmeter à ø 6 mm und 20 mm Länge
 5 anchor bolt / running meter à ø 6 mm and 20 mm length

329 Treppenkante 20 x 40 x 1,5 mm mit Prägelochnung und Anker, Edelstahl matt, gebohrt, mit Schutzfolie

stair nosing 20 x 40 x 1,5 mm with embossed punching + anchor, stainless steel matt, drilled, with protective film

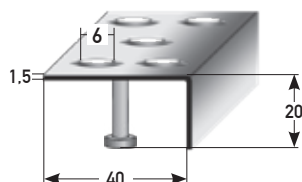

R12

5 Bolzen / Laufmeter à ø 6 mm und 20 mm Länge
 5 anchor bolt / running meter à ø 6 mm and 20 mm length

330 Treppenkante 25 x 60 x 1,5 mm mit Prägelochnung und Anker, Edelstahl matt, gebohrt, mit Schutzfolie

stair nosing 25 x 60 x 1,5 mm with embossed punching + anchor, stainless steel matt, drilled, with protective film

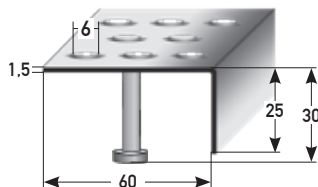

R12

5 Bolzen / Laufmeter à ø 6 mm und 30 mm Länge
 5 anchor bolt / running meter à ø 6 mm and 30 mm length

331 Treppenkante 25 x 80 x 1,5 mm mit Prägelochnung und Anker, Edelstahl matt, gebohrt, mit Schutzfolie

stair nosing 25 x 80 x 1,5 mm with embossed punching + anchor, stainless steel matt, drilled, with protective film

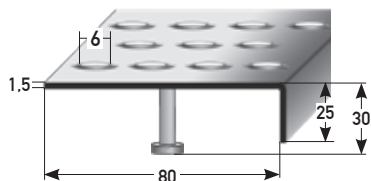

R12

5 Bolzen / Laufmeter à ø 6 mm und 30 mm Länge
 5 anchor bolt / running meter à ø 6 mm and 30 mm length

332 Treppenkante 50 x 80 x 1,5 mm mit Prägelochnung und Anker, Edelstahl matt, gebohrt, mit Schutzfolie

stair nosing 50 x 80 x 1,5 mm with embossed punching + anchor, stainless steel matt, drilled, with protective film

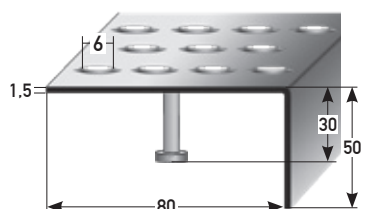

R12

5 Bolzen / Laufmeter à ø 6 mm und 30 mm Länge
 5 anchor bolt / running meter à ø 6 mm and 30 mm length

Lieferzeit nach vorheriger Absprache
 delivery time by prior arrangement

3,0 m-Ware ist nur per Spedition lieferbar (gesonderte Transportkosten)
 3.0 m profiles are only available per forwarding agency (separate transport costs)



Fertigung auf Fixlängen auf Anfrage möglich
production of end lenght possible on request

Edelstahl-Treppenkanten Noppenprägung, matt gebürstet, mit Schutzfolie, VE 1 Stück

stainless steel stair nosings with nub embossing, matt brushed, unit 1 pcs.

Noppenaußenmaß nub outside dimension	L / l (m)	Art. / ref.	€ / Stk. / pcs.
---	-----------	-------------	-----------------

507 Treppenkante 20 x 40 x 1,5 mm mit 5 mm-Noppenprägung, Edelstahl matt, gebohrt

stair nosing 20 x 40 x 1,5 mm with 5 mm nub embossing, stainless steel matt, drilled

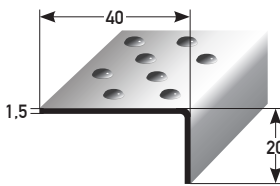

5 mm	1.0 m	71632-7	
	2.5 m	71634-1	

508 Treppenkante 25 x 60 x 1,5 mm mit 5 mm-Noppenprägung, Edelstahl matt, gebohrt

stair nosing 25 x 60 x 1,5 mm with 5 mm nub embossing, stainless steel matt, drilled

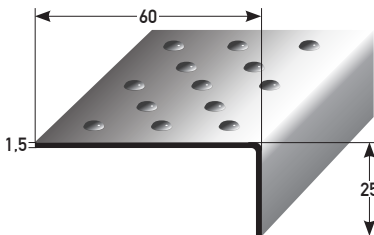

5 mm	1.0 m	71636-5	
	2.5 m	71638-9	

509 Treppenkante 20 x 40 x 1,5 mm mit 8 mm-Noppenprägung, Edelstahl matt, gebohrt

stair nosing 20 x 40 x 1,5 mm with 8 mm nub embossing, stainless steel matt, drilled

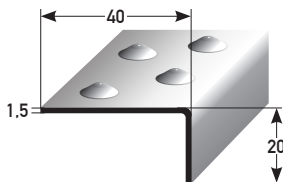

8 mm	1.0 m	71640-2	
	2.5 m	71642-6	

510 Treppenkante 25 x 60 x 1,5 mm mit 8 mm-Noppenprägung, Edelstahl matt, gebohrt

stair nosing 25 x 60 x 1,5 mm with 8 mm nub embossing, stainless steel matt, drilled

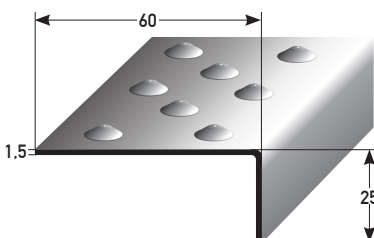

8 mm	1.0 m	71644-0	
	2.5 m	71646-4	

Befestigung mit Anker auf Anfrage erhältlich
fixing with anchor bolt available on request



Fliesen-Treppenkante mit Noppenprägung, Edelstahl matt gebürstet, mit Schutzfolie, VE 1 Stück

tile stair nosing with nub embossing, stainless steel matt brushed, with protective film, 1 piece

Belaghöhe Innenmaß (h) flooring height inside dimension (h)	L / l (m)	Art. / ref.	€/Stk. / pcs.
--	-----------	-------------	---------------

523 Fliesen-Treppenkante 25 x 1,0 mm mit 5 mm-Noppenprägung, Edelstahl matt, mit Dreieckstanzung

tile stair nosing 25 x 1.0 mm with 5 mm knob embossing, stainless steel matt, with triangular punching

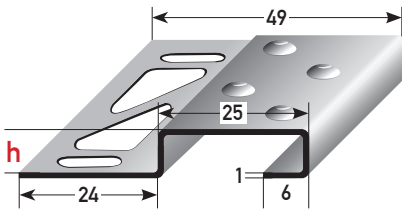

6 mm	2.5	71920-5	
8 mm		71922-9	

Seitliche Abdeckkappen und andere Höhen auf Anfrage erhältlich!
Lateral cover caps and other heights available on request!



3. Wand-, Kantenschutz- & Spezialprofile aus Edelstahl, Aluminium und Messing

3. wall + corner protection + special profiles out of stainless steel + aluminium + brass

3

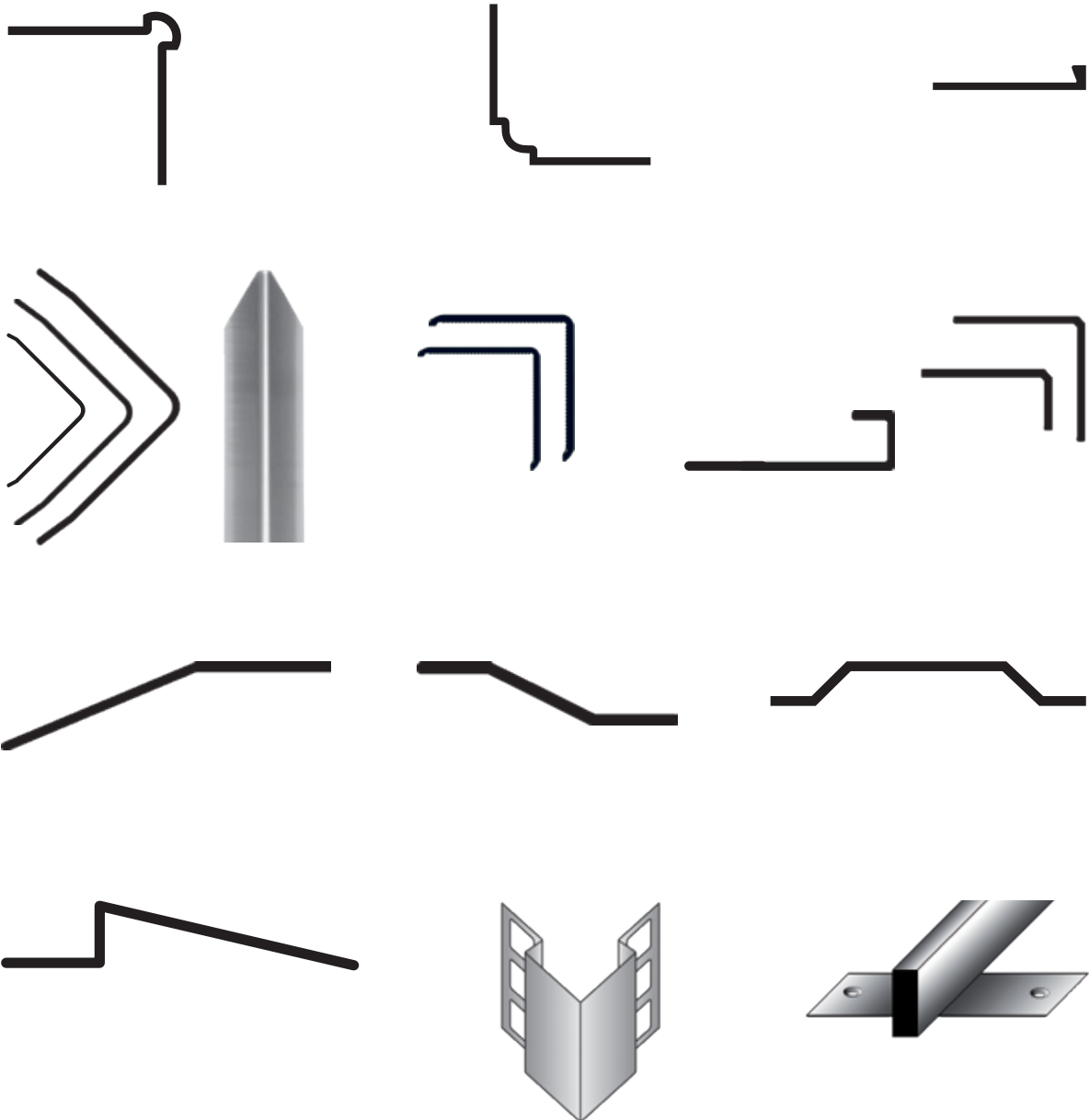

Andere Eloxalfarben siehe Abschnitt 6. Lieferzeit 14 Tage / Lieferzeit für Pulverbeschichtet auf Anfrage / other anodized colours see section 6, delivery time 14 days / delivery time for powder coating on request

Wand- und Anstoßprofile aus Aluminium

wall profiles and edge profile out of aluminium

Farbe / colour	L / l (m)	Art. / ref.	€ / Stk. / pcs.
----------------	-----------	-------------	-----------------

493 Wandprofil Außenecke 2 mm, Aluminium, ungebohrt

wall profile outside corner 2 mm, aluminium, undrilled

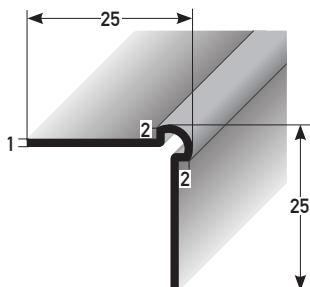

silberfarbig silver	2.7	71248-0	
edelstahlfarbig stainless steel coloured		71250-3	
Pulverbeschichtet nach RAL 9016 Verkehrsweiß powder coated to RAL 9016		71252-7	
Pulverbeschichtet nach RAL Preis ab 150 lfm. powder RAL: price from 150m	2.7	71254-1	
Pulvern nach RAL unter 150 lfm. auf Anfrage powdered (RAL) less than 150m on request			

493 Wandprofil Außenecke 2 mm, Aluminium, mit Dreieckstanzung

wall profile outside corner 2 mm, aluminium, triangle punching

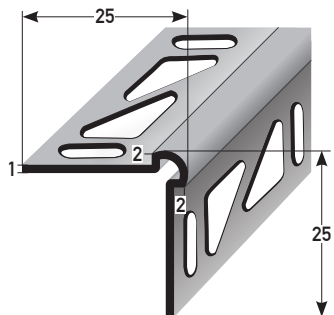

silberfarbig silver	2.7	71650-1	
edelstahlfarbig stainless steel coloured		71652-5	
Pulverbeschichtet nach RAL 9016 Verkehrsweiß powder coated to RAL 9016		71654-9	
Pulverbeschichtet nach RAL Preis ab 150 lfm. powder RAL: price from 150m	2.7	71656-3	
Pulvern nach RAL unter 150 lfm. auf Anfrage powdered (RAL) less than 150m on request			

511 Wandprofil Außenecke 3 mm, Aluminium, ungebohrt

wall profile outside corner 3 mm, aluminium, undrilled

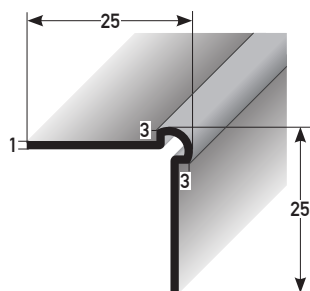

silberfarbig silver	2.7	71660-0	
edelstahlfarbig stainless steel coloured		71662-4	
Pulverbeschichtet nach RAL 9016 Verkehrsweiß powder coated to RAL 9016		71664-8	
Pulverbeschichtet nach RAL Preis ab 150 lfm. powder RAL: price from 150m	2.7	71666-2	
Pulvern nach RAL unter 150 lfm. auf Anfrage powdered (RAL) less than 150m on request			

511 Wandprofil Außenecke 3 mm, Aluminium, mit Dreieckstanzung

wall profile outside corner 3 mm, aluminium, triangle punching

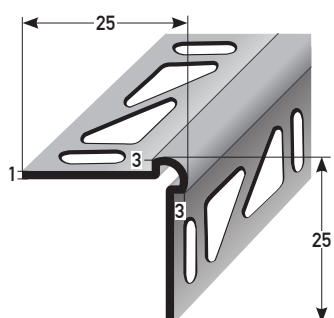

silberfarbig silver	2.7	71670-9	
edelstahlfarbig stainless steel coloured		71672-3	
Pulverbeschichtet nach RAL 9016 Verkehrsweiß powder coated to RAL 9016		71674-7	
Pulverbeschichtet nach RAL Preis ab 150 lfm. powder RAL: price from 150m	2.7	71676-1	
Pulvern nach RAL unter 150 lfm. auf Anfrage powdered (RAL) less than 150m on request			

Andere Eloxalfarben siehe Abschnitt 6, Lieferzeit 14 Tage / Lieferzeit für Pulverbeschichtet auf Anfrage / other anodized colours see section 6, delivery time 14 days / delivery time for powder coating on request

Wand- und Anstoßprofile aus Aluminium

wall profiles and edge profile out of aluminium

Farbe / colour	L / l (m)	Art. / ref.	€/Stk. / pcs.
----------------	-----------	-------------	---------------

494 Wandprofil Innenecke 2 mm, Aluminium, ungebohrt

wall profile inside corner 2 mm, aluminium, undrilled

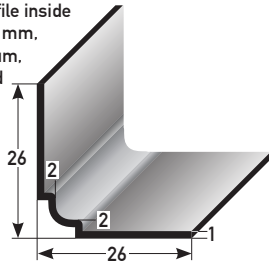

silberfarbig / silver	2.7	71268-8	
edelstahlfarbig / stainless steel coloured		71270-1	
Pulverbeschichtet nach RAL 9016 Verkehrsweiß powder coated to RAL 9016		71272-5	
Pulverbeschichtet nach RAL Preis ab 150 lfm. powder RAL; price from 150m	2.7	71274-9	
		Pulvern nach RAL unter 150 lfm. auf Anfrage powdered (RAL) less than 150m on request	

494 Wandprofil Innenecke 2 mm, Aluminium, mit Dreieckstanzung

wall profile inside corner 2 mm, aluminium, triangle punching

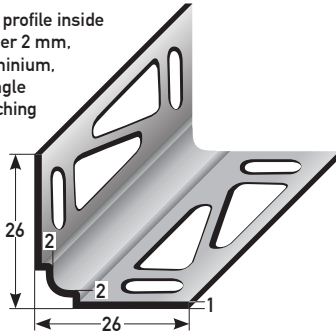

silberfarbig / silver	2.7	71680-8	
edelstahlfarbig / stainless steel coloured		71682-2	
Pulverbeschichtet nach RAL 9016 Verkehrsweiß powder coated to RAL 9016		71684-6	
Pulverbeschichtet nach RAL Preis ab 150 lfm. powder RAL; price from 150m	2.7	71686-0	
		Pulvern nach RAL unter 150 lfm. auf Anfrage powdered (RAL) less than 150m on request	

512 Wandprofil Innenecke 3 mm, Aluminium, ungebohrt

wall profile inside corner 3 mm, aluminium, undrilled

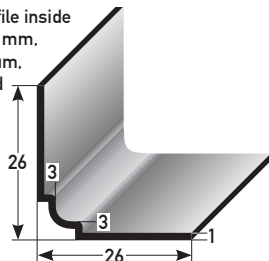

silberfarbig / silver	2.7	71690-7	
edelstahlfarbig / stainless steel coloured		71692-1	
Pulverbeschichtet nach RAL 9016 Verkehrsweiß powder coated to RAL 9016		71694-5	
Pulverbeschichtet nach RAL Preis ab 150 lfm. powder RAL; price from 150m	2.7	71696-9	
		Pulvern nach RAL unter 150 lfm. auf Anfrage powdered (RAL) less than 150m on request	

512 Wandprofil Innenecke 3 mm, Aluminium, mit Dreieckstanzung

wall profile inside corner 3 mm, aluminium, triangle punching

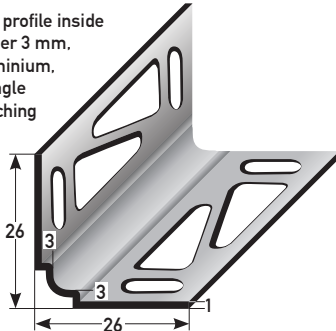

silberfarbig / silver	2.7	71700-3	
edelstahlfarbig / stainless steel coloured		71702-7	
Pulverbeschichtet nach RAL 9016 Verkehrsweiß powder coated to RAL 9016		71704-1	
Pulverbeschichtet nach RAL Preis ab 150 lfm. powder RAL; price from 150m	2.7	71706-5	
		Pulvern nach RAL unter 150 lfm. auf Anfrage powdered (RAL) less than 150m on request	

495 Anstoßprofil 2 mm, Aluminium, ungebohrt

edge profile 2 mm, aluminium anodized, undrilled

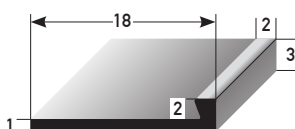

silberfarbig / silver	2.7	71310-4	
edelstahlfarbig / stainless steel coloured		71312-8	
Pulverbeschichtet nach RAL 9016 Verkehrsweiß powder coated to RAL 9016		71314-2	
Pulverbeschichtet nach RAL Preis ab 150 lfm. powder RAL; price from 150m	2.7	71316-6	
		Pulvern nach RAL unter 150 lfm. auf Anfrage powdered (RAL) less than 150m on request	



Andere Eloxalfarben siehe Abschnitt 6.
Lieferzeit 14 Tage / Lieferzeit für Pulverbeschichtet auf Anfrage / other anodized colours see section 6, delivery time 14 days / delivery time for powder coating on request

Eckschutzwinkel ohne Spitze aus Aluminium

corner protection angles without tip out of Aluminium

Farbe/colour	L/l (m)	selbstklebend self-adhesive	€/Stk. / pcs.	ohne alles / plain	€/Stk. / pcs.
--------------	---------	-----------------------------	---------------	--------------------	---------------

337 Eckschutzwinkel 20 x 20 x 1,8 mm, ohne Spitze, Aluminium

corner protection angle
20 x 20 x 1,8 mm, without tip, aluminium

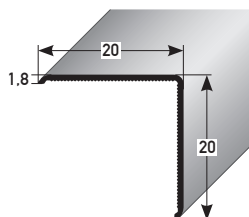

silberfarbig silver	1.0	65810-8		65792-7	
	1.25	65812-2		65794-1	
	2.5	65814-6		65796-5	
edelstahlfarbig / AL-INOX stainless steel coloured	1.0	65816-0		65798-9	
	1.25	65818-4		65800-9	
	2.5	65820-7		65802-3	
Pulverbeschichtet nach RAL 9016 Verkehrsweiß powder RAL 9016	1.0	65834-4		65828-3	
	1.25	65836-8		65830-6	
	2.5	65838-2		65832-0	
Pulverbeschichtet nach RAL / powdered RAL: Preis ab 150 lfm. / price from 150 m	1.0	65822-1		65804-7	
	1.25	65824-5		65806-1	
	2.5	65826-9		65808-5	
Pulvern nach RAL unter 150 lfm. auf Anfrage powdered (RAL) less than 150 m on request					

338 Eckschutzwinkel 25 x 25 x 1,9 mm, ohne Spitze, Aluminium

corner protection angle
25 x 25 x 1,9 mm, without tip, aluminium

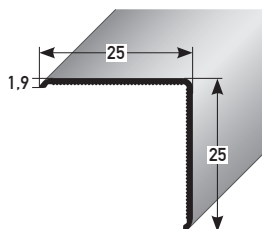

silberfarbig silver	1.0	65888-7		65870-2	
	1.25	65890-0		65872-6	
	2.5	65892-4		65874-0	
edelstahlfarbig / AL-INOX stainless steel coloured	1.0	65894-8		65876-4	
	1.25	65896-2		65878-8	
	2.5	65898-6		65880-1	
Pulverbeschichtet nach RAL 9016 Verkehrsweiß / powder RAL 9016	1.0	65912-9		65906-8	
	1.25	65914-3		65908-2	
	2.5	65916-7		65910-5	
Pulverbeschichtet nach RAL / powder RAL: Preis ab 150 lfm. / price from 150 m	1.0	65900-6		65882-5	
	1.25	65902-0		65884-9	
	2.5	65904-4		65886-3	
Pulvern nach RAL unter 150 lfm. auf Anfrage powdered (RAL) less than 150 m on request					

503 Eckschutzwinkel 30 x 30 x 1,9 mm, ohne Spitze, Aluminium

corner protection angle
30 x 30 x 1,9 mm, without tip, aluminium

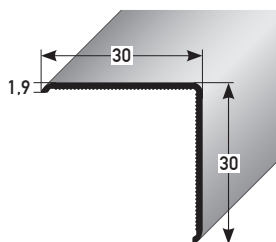

silberfarbig silver	1.0	71434-7		71410-1	
	1.25	71436-1		71412-5	
	2.5	71438-5		71414-9	
edelstahlfarbig / AL-INOX stainless steel coloured	1.0	71440-8		71416-3	
	1.25	71442-2		71418-7	
	2.5	71444-6		71420-0	
Pulverbeschichtet nach RAL 9016 Verkehrsweiß powder RAL 9016	1.0	71446-0		71422-4	
	1.25	71448-4		71424-8	
	2.5	71450-7		71426-2	
Pulverbeschichtet nach RAL / powdered RAL: Preis ab 150 lfm. / price from 150 m	1.0	71452-1		71428-6	
	1.25	71454-5		71430-9	
	2.5	71456-9		71432-3	
Pulvern nach RAL unter 150 lfm. auf Anfrage powdered (RAL) less than 150 m on request					

Andere Abmaße auf Anfrage
other dimensions on demand

Eckschutzwinkel mit Spitze aus Edelstahl (V2A)

corner protection angles with tip out of stainless steel (V2A)

Material / material	L / l (m)	selbstklebend self-adhesive	€/Stk. / pcs.	ohne alles / plain	€/Stk. / pcs.
---------------------	-----------	-----------------------------	---------------	--------------------	---------------

481 Eckschutzwinkel 20 x 20 x 1 mm, Edelstahl matt, dreifach gekantet

corner protection angle
20 x 20 x 1 mm, stainless steel,
matt tripple edged

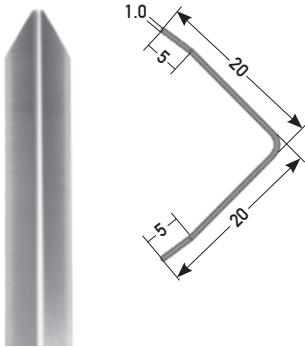

Edelstahl matt stainless steel matt	1.0	70958-9		70966-4	
	1.25	70960-2		70968-8	
	1.5	70962-6		70970-1	
	2.5	70964-0		70972-5	

Andere Eloxalfarben
siehe Abschnitt 6.
Lieferzeit 14 Tage
other anodized colours
see section 6.
delivery time 14 days

Eckschutzwinkel mit Spitze aus Edelstahl (V2A) und Aluminium

corner protection angles with tip out of stainless steel (V2A) and aluminium

Dicke (mm)/ thickness	L / l (m)	selbstklebend self-adhesive	gebohrt siehe* drilled see*	€/Stk. / pcs.	ohne alles / plain	€/Stk. / pcs.
--------------------------	-----------	--------------------------------	--------------------------------	---------------	-----------------------	---------------

209 Eckschutzwinkel 30 x 30 mm, dreifach gekantet

corner protection angle
30 x 30 mm, tripple edged

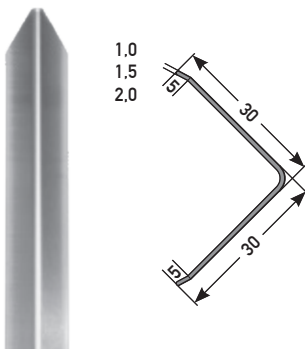

Edelstahl matt stainless steel matt	1.0 mm	1.0	60824-0	60812-7		60800-4
		1.25	60825-7	60813-4		60801-1
		1.5	66238-9	66236-5		66234-1
		2.5	60826-4	60814-1		60802-8
	1.5 mm	1.0	60828-8	60816-5		60804-2
		1.25	60829-5	60817-2		60805-9
		1.5	66244-0	66242-6		66240-2
		2.5	60830-1	60818-9		60806-6
	2.0 mm	1.0	60832-5	60820-2		60808-0
		1.25	60833-2	60821-9		60809-7
		1.5	66250-1	66248-8		66246-4
		2.5	60834-9	60822-6		60810-3

Alu walzblank mill finish	1.5 mm	1.0	60960-5	60958-2		60956-8
		1.5	66258-7	66256-3		66254-9
		2.5	60961-2	60959-9		60957-5
	2.0 mm	1.0	60680-2	60970-4		60968-1
		1.5	66264-8	66262-4		66260-0
		2.5	60690-1	60971-1		60969-8

Alu silber elox. silver anodized	1.5 mm	1.0	60966-7	60964-3		60962-9
		1.5	66270-9	66268-6		66266-2
		2.5	60967-4	60965-0		60963-6
	2.0 mm	1.0	60976-6	60974-2		60972-8
		1.5	66276-1	66274-7		66272-3
		2.5	60977-3	60975-9		60973-5

* Bitte Bohrtyp angeben:

- 01 einseitig seitlich
- 02 einseitig mittig
- 03 wechselseitig seitlich
- 04 wechselseitig mittig
- 05 im Knick

* Please specify drill holes:

- 01 single sided laterally
- 02 single sided centrally
- 03 alternating sides laterally
- 04 alternating sides centrally
- 05 in edge

passende Edelstahlschrauben siehe Abschnitt 12
suitable stainless steel screws see section 12



Andere Abmaße auf Anfrage /
Andere Eloxfarben siehe
Abschnitt 6, Lieferzeit 14 Tage
other dimensions on demand / other
anodized colours see section 6,
delivery time 14 days

Eckschutzwinkel mit Spitze aus Edelstahl (V2A) und Aluminium						
corner protection angles with tip out of stainless steel (V2A) and aluminium						
Dicke (mm) / thickness	L / l (m)	selbstklebend self-adhesive	gebohrt siehe* drilled see*	€/Stk. / pcs.	ohne alles / plain	€/Stk. / pcs.

210 Eckschutzwinkel 40 x 40 mm, dreifach gekantet

corner protection angle
40 x 40 mm, tripple edged

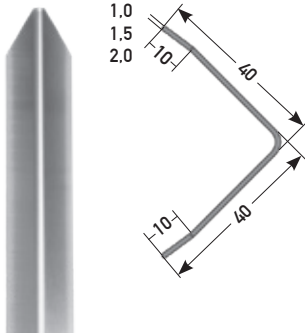

* Bitte Bohrtyp angeben:

- 01 einseitig seitlich
- 02 einseitig mittig
- 03 wechselseitig seitlich
- 04 wechselseitig mittig
- 05 im Knick

* Please specify drill holes:

- 01 single sided laterally
- 02 single sided centrally
- 03 alternating sides laterally
- 04 alternating sides centrally
- 05 in edge

Edelstahl matt stainless steel matt	Dicke (mm)	L (m)		selbstklebend		gebohrt	
		1.0	1.25	60185-2	60848-6	€/Stk.	€/Stk.
1.0 mm	1.0	1.0	1.25	60185-2	60848-6		60836-3
	1.25	1.5	2.5	60190-6	60849-3		60837-0
	1.5	2.5	2.5	66284-6	66282-2		66280-8
1.5 mm	1.0	1.0	1.25	60200-2	60850-9		60838-7
	1.25	1.5	2.5	60165-4	60852-3		60840-0
	1.5	2.5	2.5	60170-8	60853-0		60841-7
2.0 mm	1.0	1.0	1.25	66290-7	66288-4		66286-0
	1.25	1.5	2.5	60180-7	60854-7		60842-4
	1.5	2.5	2.5	60650-5	60856-1		60844-8
2.0 mm	1.0	1.25	2.5	60655-0	60857-8		60845-5
	1.25	1.5	2.5	66296-9	66294-5		66292-1
	1.5	2.5	2.5	60660-4	60858-5		60846-2

Alu walzblank mill finish	Dicke (mm)	L (m)		selbstklebend		gebohrt	
		1.0	1.25				
1.5 mm	1.0	1.0	1.25	60982-7	60980-3		60978-0
	1.25	1.5	2.5	66304-1	66302-7		66300-3
	1.5	2.5	2.5	60983-4	60981-0		60979-7
2.0 mm	1.0	1.0	1.25	60992-6	60990-2		60665-9
	1.25	1.5	2.5	66310-2	66308-9		66306-5
	1.5	2.5	2.5	60993-3	60991-9		60675-8

Alu silber elox. silver anodized	Dicke (mm)	L (m)		selbstklebend		gebohrt	
		1.0	1.25				
1.5 mm	1.0	1.0	1.25	60988-9	60986-5		60984-1
	1.25	1.5	2.5	66316-4	66314-0		66312-6
	1.5	2.5	2.5	60989-6	60987-2		60985-8
2.0 mm	1.0	1.0	1.25	60998-8	60996-4		60994-0
	1.25	1.5	2.5	66322-5	66320-1		66318-8
	1.5	2.5	2.5	60999-5	60997-1		60995-7

211 Eckschutzwinkel 50 x 50 mm, Edelstahl matt, dreifach gekantet

corner protection angle
50 x 50 mm, stainless steel matt,
trippel edged

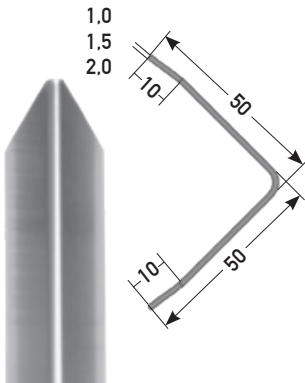

* Bitte Bohrtyp angeben:

- 01 einseitig seitlich
- 02 einseitig mittig
- 03 wechselseitig seitlich
- 04 wechselseitig mittig
- 05 im Knick

* Please specify drill holes:

- 01 single sided laterally
- 02 single sided centrally
- 03 alternating sides laterally
- 04 alternating sides centrally
- 05 in edge

Edelstahl matt stainless steel matt	Dicke (mm)	L (m)		selbstklebend		gebohrt	
		1.00	1.25				
1.0 mm	1.00	1.00	1.25	60896-7	60884-4		60872-1
	1.25	1.50	2.50	60897-4	60885-1		60873-8
	1.50	2.50	2.50	66330-0	66328-7		66326-3
1.5 mm	1.00	1.00	1.25	60898-1	60886-8		60874-5
	1.25	1.50	2.50	60900-1	60888-2		60876-9
	1.50	2.50	2.50	60901-8	60889-9		60877-6
2.0 mm	1.00	1.00	1.25	66336-2	66334-8		66332-4
	1.25	1.50	2.50	60902-5	60890-5		60878-3
	1.50	2.50	2.50	60904-9	60892-9		60880-6
2.0 mm	1.00	1.25	2.50	60905-6	60893-6		60881-3
	1.25	1.50	2.50	66342-3	66340-9		66338-6
	1.50	2.50	2.50	60906-3	60894-3		60882-0

Andere Gradzahlen auf Anfrage möglich!

Other degree values on request!

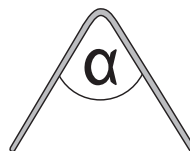

Andere Abmaße auf Anfrage
other dimensions on demand

Edelstahl-Abkantprofile, matt gebürstet, mit Schutzfolie

stainless steel edge profiles, matt brushed, with protective foil

Koffernr./ case no.	L / l (m)	A x B x C (mm)	Art./ref.	€/Stk./ pcs.
---------------------	-----------	----------------	-----------	--------------

212-214 Deko-Winkel 1,5/2,0/3,0 mm, Edelstahl matt, ungebohrt

deco-angle 1,5 / 2,0 / 3,0 mm
stainless steel matt, undrilled

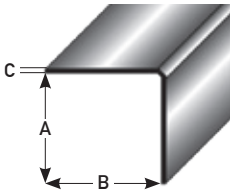

212	2,5	20 x 20 x 1,5	60210-1	
213		30 x 30 x 1,5	60220-0	
214		40 x 40 x 1,5	60230-9	
213		30 x 30 x 2,0	60430-3	
214		40 x 40 x 2,0	60440-2	
214		40 x 40 x 3,0	60470-9	

Bohrung oder selbstklebend auf Anfrage
drill holes or self-adhesive on request

215-217 Deko-L-Winkel 1,5/2,0 mm, Edelstahl matt, ungebohrt

deco-L-angle 1,5 / 2,0 mm stainless
steel matt, undrilled

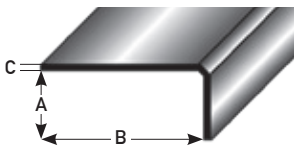

215	2,5	15 x 30 x 1,5	60240-8	
216		20 x 40 x 1,5	60250-7	
217		30 x 50 x 1,5	60260-6	
216		20 x 40 x 2,0	60450-1	
217		30 x 50 x 2,0	60460-0	

Bohrung oder selbstklebend auf Anfrage
drill holes or self-adhesive on request

227 Ausgleichprofil mit zwei Befestigungsschenkel, Edelstahl matt, gebohrt

level compensation profile with two
attachment flanges, stainless steel
matt, drilled

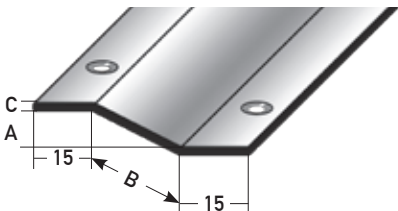

2,5	8 x 30 x 1,0	60330-6	
	10 x 30 x 1,0	60340-5	
	13 x 35 x 1,5	60350-4	
	15 x 40 x 1,5	60360-3	
	22 x 55 x 1,5	60370-2	
	13 x 35 x 2,0	60480-8	
	15 x 40 x 2,0	60490-7	
	20 x 80 x 3,0	60491-4	

218-222 477 Einschubprofile, Edelstahl matt, gebohrt

insert profile, stainless steel matt,
drilled

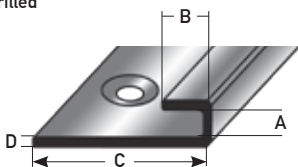

		A x B x C x D (mm)		
2,5	477	5 x 5 x 34 x 1,0	60268-2	
	218	8 x 8 x 34 x 1,0	60270-5	
	219	10 x 10 x 34 x 1,0	60280-4	
	220	13 x 10 x 34 x 1,0	60290-3	
	221	15 x 10 x 34 x 1,0	60300-9	
	222	22 x 10 x 34 x 1,0	60310-8	



Beispiel: Edelstahl-Mattenrahmen-Profil (siehe Seite 48)
example: stainless steel frame profile (see page 48)



Miniwinkel profiliert, ungebohrt, Sichtseite aussen

mini angle profiles, undrilled, visible side outside

Material/material	L/l (m)	m/VE/unit	A x B x C (mm)	Art./ref.	€/m
-------------------	---------	-----------	----------------	-----------	-----

235 Miniwinkel gleichschenkelig, Innenradius 0,3 mm, außen Rundkante, ungebohrt

mini angle profile, equal size sides, inside radius 0,3 mm, round edge, undrilled

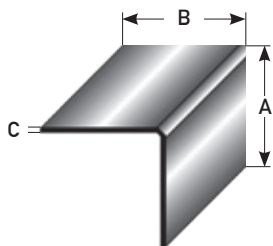

Edelstahl matt / stainless steel matt	2,7	27	10 x 10 x 1,0	44800-6	
Edelstahl matt / stainless steel matt	2,7		10 x 10 x 1,5	44802-0	
Messing poliert / brass polished	2,7		10 x 10 x 1,2	44804-4	
Edelstahl matt / stainless steel matt	2,7	27	15 x 15 x 1,0	44806-8	
Edelstahl matt / stainless steel matt	2,7		15 x 15 x 1,5	44808-2	
Messing poliert / brass polished	2,7		15 x 15 x 1,0	44810-5	
Edelstahl matt / stainless steel matt	2,7	27	20 x 20 x 1,0	44812-9	
Edelstahl matt / stainless steel matt	2,7		20 x 20 x 1,5	44814-3	
Messing poliert / brass polished	2,7		20 x 20 x 1,0	44816-7	

236 Miniwinkel ungleichschenkelig, Innenradius 0,3 mm, außen Rundkante, ungebohrt

mini angle profile, different size sides, inside radius 0,3 mm, round edge, undrilled

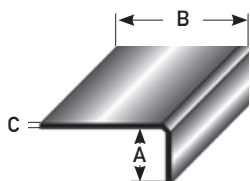

Edelstahl matt / stainless steel matt	2,7	27	3,5 x 16,5 x 1,0	44818-1	
Messing poliert / brass polished	2,7		3,5 x 16,5 x 1,2	44820-4	
Edelstahl matt / stainless steel matt	2,7	27	3 x 25 x 1,0	44822-8	
Messing poliert / brass polished	2,7		3 x 25 x 1,0	44824-2	
Edelstahl matt / stainless steel matt	2,7	27	2,5 x 33,5 x 1,0	44826-6	
Edelstahl matt / stainless steel matt	2,7		3 x 34 x 1,0	44828-0	
Messing poliert / brass polished	2,7		3 x 34 x 1,0	44830-3	
Edelstahl matt / stainless steel matt	2,7	27	4 x 24 x 1,5	44832-7	
Edelstahl matt / stainless steel matt	2,7	27	5 x 15 x 1,0	44834-1	
Edelstahl matt / stainless steel matt	2,7		5 x 15 x 1,5	44836-5	
Messing poliert / brass polished	2,7		5 x 15 x 1,2	44838-9	
Edelstahl matt / stainless steel matt	2,7	27	5 x 22 x 1,0	44840-2	
Edelstahl matt / stainless steel matt	2,7		5 x 22 x 1,5	44842-6	
Messing poliert / brass polished	2,7		5 x 22 x 1,0	44844-0	
Edelstahl matt / stainless steel matt	2,7	27	5 x 32 x 1,0	44846-4	
Edelstahl matt / stainless steel matt	2,7		5 x 32 x 1,5	44848-8	
Messing poliert / brass polished	2,7		5 x 32 x 1,0	44850-1	
Edelstahl matt / stainless steel matt	2,7	27	6 x 21 x 1,0	44852-5	
Edelstahl matt / stainless steel matt	2,7		6 x 21 x 1,5	44854-9	
Messing poliert / brass polished	2,7		6 x 21 x 1,0	44856-3	
Edelstahl matt / stainless steel matt	2,7	27	8 x 19 x 1,0	44858-7	
Edelstahl matt / stainless steel matt	2,7		8 x 19 x 1,5	44860-0	
Messing poliert / brass polished	2,7		8 x 19 x 1,0	44862-4	
Edelstahl matt / stainless steel matt	2,7	27	8 x 29 x 1,0	44864-8	
Edelstahl matt / stainless steel matt	2,7		8 x 29 x 1,5	44866-2	
Messing poliert / brass polished	2,7		8 x 29 x 1,0	44868-6	
Edelstahl matt / stainless steel matt	2,7	27	10 x 17 x 1,0	44870-9	
Edelstahl matt / stainless steel matt	2,7		10 x 17 x 1,5	44872-3	
Messing poliert / brass polished	2,7		10 x 17 x 1,0	44874-7	
Edelstahl matt / stainless steel matt	2,7	27	10 x 27 x 1,0	44876-1	
Edelstahl matt / stainless steel matt	2,7		10 x 27 x 1,5	44878-5	
Messing poliert / brass polished	2,7		10 x 27 x 1,0	44880-8	
Edelstahl poliert / stainless steel polished	2,7	27	12 x 26 x 1,5	44882-2	
Edelstahl matt / stainless steel matt	2,7		15 x 22 x 1,0	44884-6	
Edelstahl matt / stainless steel matt	2,7		15 x 22 x 1,5	44886-0	
Messing poliert / brass polished	2,7		15 x 22 x 1,0	44888-4	

Maßtoleranz ± 1 mm
andere Abmessungen und Oberflächen
auf Anfrage
tolerance ± 1 mm, other sizes
and finishes available on
request

Andere Abmaße, ungebohrt oder Lochbild auf Anfrage
other dimensions, undrilled or custom drill hole on demand

Niveauequalsprofile für individuelle Höhen,
Edelstahl matt, VE 1 Stück
levelling profiles for individual heights, stainless steel matt, unit 1 pcs.

397 Niveauequals 15 x 20 x 1,5/2,0/3,0 mm, Edelstahl matt, gebohrt

level compensation profile
15 x 20 x 1,5 / 2,0 / 3,0 mm,
stainless steel matt, drilled

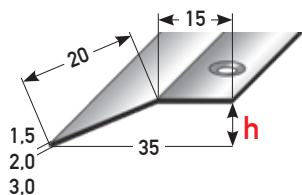

L / l (m)	1,5 mm Materialstärke / thickness		2,0 mm Materialstärke / thickness		3,0 mm Materialstärke / thickness	
	Art. / ref.	€/Stk. / pcs.	Art. / ref.	€/Stk. / pcs.	Art. / ref.	€/Stk. / pcs.
1.0	67370-5		67376-7		67382-8	
1.25	67372-9		67378-1		67384-2	
2.5	67374-3		67380-4		67386-6	

3,0 mm Material für
Gabelstapler + Hubwagen
3,0 mm material for
forklifts + pallet trucks

individuelle Höhe = h immer angeben!

individual height = h – always specify!

Wir empfehlen bei dieser Profildbreite eine maximale Ausgleichshöhe von bis zu 8 mm.
We recommend a maximum height compensation of up to 8 mm for this profile width.

398 Niveauequals 15 x 30 x 1,5/2,0/3,0 mm, Edelstahl matt, gebohrt

level compensation profile
15 x 30 x 1,5 / 2,0 / 3,0 mm,
stainless steel matt, drilled

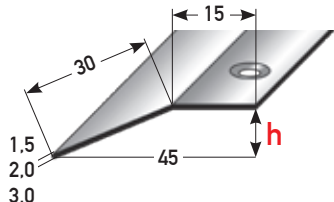

L / l (m)	1,5 mm Materialstärke / thickness		2,0 mm Materialstärke / thickness		3,0 mm Materialstärke / thickness	
	Art. / ref.	€/Stk. / pcs.	Art. / ref.	€/Stk. / pcs.	Art. / ref.	€/Stk. / pcs.
1.0	67394-1		67400-9		67406-1	
1.25	67396-5		67402-3		67408-5	
2.5	67398-9		67404-7		67410-8	

3,0 mm Material für
Gabelstapler + Hubwagen
3,0 mm material for
forklifts + pallet trucks

individuelle Höhe = h immer angeben!

individual height = h – always specify!

Wir empfehlen bei dieser Profildbreite eine maximale Ausgleichshöhe von bis zu 15 mm.
We recommend a maximum height compensation of up to 15 mm for this profile width.

241 Niveauequals 20 x 50 x 1,5/2,0/3,0 mm, Edelstahl matt, gebohrt

level compensation profile
20 x 50 x 1,5 / 2,0 / 3,0 mm,
stainless steel matt, drilled

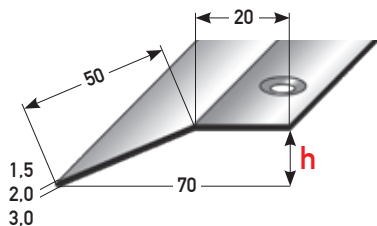

L / l (m)	1,5 mm Materialstärke / thickness		2,0 mm Materialstärke / thickness		3,0 mm Materialstärke / thickness	
	Art. / ref.	€/Stk. / pcs.	Art. / ref.	€/Stk. / pcs.	Art. / ref.	€/Stk. / pcs.
1.0	60145-6		60635-2		60760-1	
1.25	60150-0		60640-6		60765-6	
2.5	60160-9		60645-1		60770-0	

3,0 mm Material für
Gabelstapler + Hubwagen
3,0 mm material for
forklifts + pallet trucks

individuelle Höhe = h immer angeben!

individual height = h – always specify!

Wir empfehlen bei dieser Profildbreite eine maximale Ausgleichshöhe von bis zu 30 mm.
We recommend a maximum height compensation of up to 30 mm for this profile width.

passende Edelstahlschrauben siehe Abschnitt 12/ suitable stainless steel screws see section 12



Andere Abmaße auf Anfrage
other dimensions on demand

passende Edelstahlschrauben
siehe Abschnitt 12 / suitable stainless
steel screws see section 12

Spezialprofile mit Schutzfolie, VE 1 Stück

custom profiles with protective film, sales unit 1 piece

Material / material	L/l (m)	A x B x C (mm)	Art./ref.	€/m
---------------------	---------	----------------	-----------	-----

230 Kabelabdeckung robust, beidseitig selbstklebend

cable cover, robust, double-
sided self-adhesive

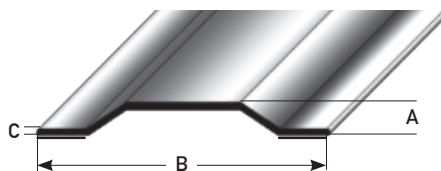

Edelstahl matt stainless steel satin	2.5 m	10 x 80 x 1,5	45500-4	
		10 x 100 x 1,5	45505-9	
		15 x 120 x 1,5	45510-3	

Aluminium walzblank Aluminium mill finish	2.5 m	10 x 80 x 2	45515-8	
		10 x 100 x 2	45520-2	
		15 x 120 x 3	45525-7	

Achtung: VDE-Vorschriften sind zu beachten! Alternative Materialstärken 2,0 und 3,0 mm auf Anfrage.
Please adhere to the law when installing electric cables! Alternative material thicknesses 2.0 and 3.0 mm on request.

231 Mattenrahmenprofil Edelstahl matt, gebohrt

frame profile, stainless steel matt, drilled

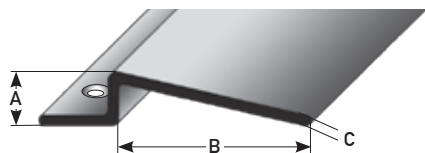

L/l (m)	A x B x C (mm)	Art./ref.	€/m
2.5 m	10 x 30 x 1,5	45541-7	
	15 x 30 x 1,5	45540-0	
	20 x 40 x 1,5	45545-5	
	25 x 50 x 1,5	45550-9	
	20 x 40 x 2	45555-4	
	25 x 50 x 2	45560-8	

Rahmenfertigung auf Anfrage / frame manufacturing on request

232 Natursteintrennprofil Edelstahl matt, gebohrt

stone separation profile,
stainless steel matt, drilled

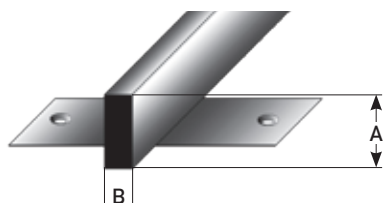

Profil auch ohne
Befestigungslaschen auf
Anfrage erhältlich
profile also available without
fastening strips on request

L/l (m)	A x B (mm)	Art./ref.	€/m
Länge auf Anfrage / length on request	10 x 3	45575-2	
	15 x 3	45580-6	
	20 x 3	45585-1	
	5 x 5	45590-5	
	10 x 5	45595-0	
	12 x 5	45600-1	
	15 x 5	45605-6	
	20 x 5	45610-0	

andere Höhen auf Anfrage / other heights on request

233 Läuferabschlussschiene schwer, Edelstahl matt, gebohrt

carpet end profile, heavy duty
stainless steel matt, drilled

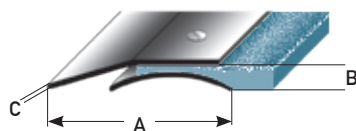

für freiliegende
Montage ohne Unter-
grundbefestigung
for exposed installation
without base attachment

L/l (m)	A x B x C (mm)	Art./ref.	€/m
2.5 m	50 x 5 x 1,5	45625-4	
	60 x 10 x 1,5	45630-8	
	70 x 15 x 1,5	45635-3	

Alternative Materialstärken 2,0 und 3,0 mm auf Anfrage
alternative material thickness 2.0 and 3.0 mm on request

Bitte die Läuferdicke angeben! / Please specify carpet thickness.

234 Flieseneckschutz Edelstahl matt 1,0 mm

ceramic tile corner protection,
stainless steel matt 1.0 mm

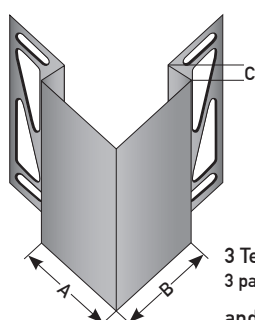

verdeckter
Befestigungsschenkel
Hohlräume mit
Mörtel hinterfüllen
hidden attachment flanges
fill any gaps with concrete

3 Teile punktgeschweißt Einbau bündig mit Belag
3 parts spot welded installation flush with flooring

andere Abmessungen und Oberflächen auf Anfrage
other sizes and surface treatments on request

L/l (m)	A x B x C (mm)	Art./ref.	€/m
2.5 m	25 x 25 x 6	45650-6	
	25 x 25 x 8	45655-1	
	25 x 25 x 10	45660-5	
	25 x 25 x 12,5	45665-0	
	30 x 30 x 6	45670-4	
	30 x 30 x 8	45675-9	
	30 x 30 x 10	45680-3	
	30 x 30 x 12,5	45685-8	
	40 x 40 x 6	45690-2	
	40 x 40 x 8	45695-7	
	40 x 40 x 10	45700-8	
	40 x 40 x 12,5	45705-3	

4. Übergangsprofile aus Aluminium, Edelstahl und Messing

4. connecting profiles out of aluminium + stainless steel + brass

4



4. ÜBERGANGSPROFILE / 4. CONNECTING PROFILES

seitlich gebohrt, ungebohrt
oder als Flachprofil auf Anfrage
erhältlich
laterally drilled, undrilled or as flat
profile available on demand

Profi-Pack à 10 Stück im Bund

professional packing à 10 pcs.

Dicke + Befestigung thickness + fixing	L / l (m)	Art. / ref.	€/Stk. / pcs.
---	-----------	-------------	---------------

SB-Pack incl. Schr. / Dübel:
VE 20 Stk.

self-service-pack with
screws / dowels: à 20 pcs.

Art. / ref.	€/Stk. / pcs.
-------------	---------------

142 Übergangsprofil 20 mm, Messing poliert, mit Schutzfolie

connecting profile 20 mm,
brass polished, with protective film

1.2 mm	mittig gebohrt centrally drilled	0.9	41200-7	
		1.0	41210-6	
		2.7	41220-5	

41201-4	
41211-3	
41221-2	

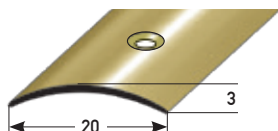

143 Übergangsprofil 20 mm, Edelstahl poliert, mit Schutzfolie

connecting profile 20 mm, stainless
steel polished, with protective film

1.0 mm	mittig gebohrt centrally drilled	0.9	41230-4	
		1.0	41240-3	
		2.7	41250-2	

41231-1	
41241-0	
41251-9	

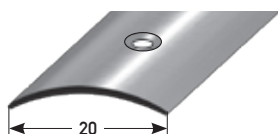

1.5 mm	mittig gebohrt centrally drilled	1.0	42220-4	
		2.7	42230-3	

42221-1	
42231-0	

2.0 mm	mittig gebohrt centrally drilled	1.0	42250-1	
		2.7	42260-0	

42251-8	
42261-7	

144 Übergangsprofil 20 mm, Edelstahl matt, mit Schutzfolie

connecting profile 20 mm, stainless
steel matt, with protective film

1.0 mm	mittig gebohrt centrally drilled	1.0	42280-8	
		2.7	42290-7	

42281-5	
42291-4	

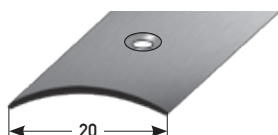

1.5 mm	mittig gebohrt centrally drilled	1.0	42310-2	
		2.7	42320-1	

42311-9	
42321-8	

2.0 mm	mittig gebohrt centrally drilled	1.0	42340-9	
		2.7	42350-8	

42341-6	
42351-5	

524 Stegübergangsprofil 20 x 3,0 mm, Aluminium eloxiert, mittig gebohrt

connecting profile with bars 20 x 3,0 mm,
aluminium anodized, centrally drilled

Farbe / colour	L / l (m)	Art. / ref.	€/Stk. / pcs.
silberfarbig silver	0.9	72058-4	
	2.7	72060-7	
edelstahlfarbig Feinschliff fine-honed stainless steel coloured	0.9	72066-9	
	2.7	72068-3	

Art. / ref.	€/Stk. / pcs.
72062-1	
72064-5	
72070-6	
72072-0	

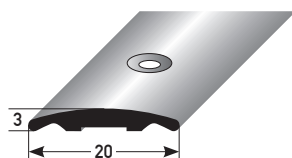

Andere Eloxalfarben siehe Abschnitt 6, Lieferzeit 14 Tage
other anodized colours see section 6, delivery time 14 days



seitlich gebohrt, ungebohrt
oder als Flachprofil auf Anfrage
erhältlich
laterally drilled, undrilled or as flat
profile available on demand

Profi-Pack à 10 Stück im Bund			
professional packing à 10 pcs.			
Dicke + Befestigung thickness + fixing	L/l (m)	Art. / ref.	€/Stk. / pcs.

SB-Pack incl. Schr. / Dübel,
VE 20 Stk.

self-service-pack with
screws / dowels; à 20 pcs.

Art. / ref.	€/Stk. / pcs.
-------------	---------------

01 Übergangsprofil 28 mm, Messing poliert, mit Schutzfolie

connecting profile 28 mm, brass
polished, with protective film

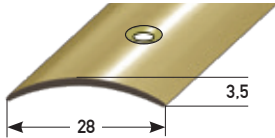

Bitte fordern Sie unsere Pflege-
hinweise für Messingprofile an!
Please ask for our care tips for
brass profiles!

Längen bis 5.0 m auf Anfrage
lengths up to 5.0 m on request

1.0 mm	mittig gebohrt centrally drilled	0.9	03090-4	
		1.0	03100-0	
		2.0	03110-9	
	seitlich gebohrt laterally drilled	0.9	03390-5	
		1.0	03400-1	
		2.0	03410-0	
	selbstklebend self-adhesive	0.9	03093-5	
		1.0	03103-1	
		2.7	03123-9	

03091-1	
03101-7	
03111-6	
03121-5	

03391-2	
03401-8	
03411-7	
03421-6	

03092-8	
03102-4	
03126-0	

1.2 mm	mittig gebohrt centrally drilled	0.9	03095-9	
		1.0	03105-5	
		2.7	03125-3	
	seitlich gebohrt laterally drilled	0.9	03094-2	
		1.0	02104-9	
		2.7	03124-6	
	selbstklebend self-adhesive	0.9	03097-3	
		1.0	03107-9	
		2.7	03127-7	

03096-6	
03106-2	
03122-2	

03099-7	
03109-3	
03129-1	

03098-0	
03108-6	
03128-4	



4. ÜBERGANGSPROFILE / 4. CONNECTING PROFILES

seitlich gebohrt, ungebohrt
oder als Flachprofil auf Anfrage
erhältlich
laterally drilled, undrilled or as flat
profile available on demand

Profi-Pack à 10 Stück im Bund			
professional packing à 10 pcs.			
Dicke + Befestigung thickness + fixing	L/l (m)	Art./ref.	€/Stk./pcs.

SB-Pack incl. Schr./Dübel: VE 20 Stk.	
self-service-pack with screws/dowels: à 20 pcs.	
Art./ref.	€/Stk./pcs.

13 Übergangsprofil 28 mm, Edelstahl poliert, mit Schutzfolie

connecting profile 28 mm, stainless
steel polished, with protective film

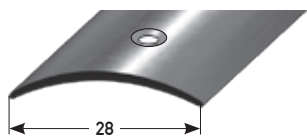

1.0 mm	mittig gebohrt centrally drilled	0.9	03190-1		03191-8		
		1.0	03200-7		03201-4		
		2.0	03210-6		03211-3		
		2.7	03220-5		03221-2		
1.0 mm	seitlich gebohrt laterally drilled	0.9	03490-2		03491-9		
		1.0	03500-8		03501-5		
		2.0	03510-7		03511-4		
		2.7	03520-6		03521-3		
1.5 mm	mittig gebohrt centrally drilled	1.0	42370-6		42371-3		
		2.7	42380-5		42381-2		
		1.5 mm	selbstklebend self-adhesive	1.0	42400-0		42401-7
2.7	42410-9				42411-6		
2.0 mm	mittig gebohrt centrally drilled	1.0	42430-7		42431-4		
		2.7	42440-6		42441-3		
	2.0 mm	selbstklebend self-adhesive	1.0	42460-4		42461-1	
			2.7	42470-3		42471-0	

14 Übergangsprofil 28 mm, Edelstahl matt, mit Schutzfolie

connecting profile 28 mm, stainless
steel matt, with protective film

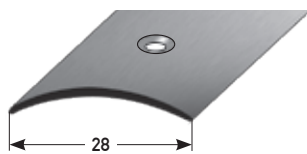

1.0 mm	mittig gebohrt centrally drilled	0.9	03690-6		03691-3	
		1.0	03700-2		03701-9	
		2.7	03720-0		03721-7	
1.0 mm	seitlich gebohrt laterally drilled	0.9	03790-3		03791-0	
		1.0	03800-9		03801-6	
		2.7	03820-7		03821-4	
1.5 mm	selbstklebend self-adhesive	0.9	03890-0		03891-7	
		1.0	03900-6		03901-3	
		2.7	03920-4		03921-1	
1.5 mm	mittig gebohrt centrally drilled	1.0	60005-3		60006-0	
		2.7	60021-3		60023-7	
1.5 mm	selbstklebend self-adhesive	1.0	60007-7		60024-4	
		2.7	60009-1		60026-8	
2.0 mm	mittig gebohrt centrally drilled	1.0	60530-0		60531-7	
		2.7	60542-3		60543-0	
2.0 mm	selbstklebend self-adhesive	1.0	60532-4		60533-1	
		2.7	60538-6		60539-3	



Andere Eloxalfarben siehe Abschnitt 6. Lieferzeit 14 Tage
other anodized colours see section 6. delivery time 14 days

Profi-Pack à 10 Stück im Bund			
professional packing à 10 pcs.			
Farbe / colour	L / l (m)	Art. / ref.	€/Stk. / pcs.

SB-Pack incl. Schr. / Dübel; VE 20 Stk.	
self-service-pack with screws / dowels; à 20 pcs.	
Art. / ref.	€/Stk. / pcs.

05 Übergangprofil 28 x 1,5 mm, Aluminium eloxiert, mittig gebohrt

connecting profile
28 x 1,5 mm, aluminium
anodized, centrally drilled

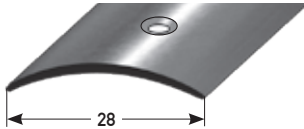

seitlich gebohrt auf Anfrage
laterally drilled on request

silberfarbig silver	0.9	08490-7	
	1.0	08500-3	
	2.0	08510-2	
	2.7	08520-1	
goldfarbig gold	0.9	08590-4	
	1.0	08600-0	
	2.0	08610-9	
	2.7	08620-8	
bronzefarbig hell bronze light	0.9	08690-1	
	1.0	08700-7	
	2.0	08710-6	
bronzefarbig dunkel bronze dark	0.9	08790-8	
	1.0	08800-4	
	2.0	08810-3	
gold hell gold light	0.9	70802-5	
	1.0	70804-9	
	2.0	70806-3	
edelstahlfarbig Feinschliff fine-honed stainless steel, coloured	0.9	70818-6	
	1.0	70820-9	
	2.0	70822-3	
schwarz black	1.0	72076-8	
	2.7	72078-2	

08491-4	
08501-0	
08511-9	
08521-8	
08591-1	
08601-7	
08611-6	
08621-5	
08691-8	
08701-4	
08711-3	
08721-2	
08791-5	
08801-1	
08811-0	
08821-9	
70810-0	
70812-4	
70814-8	
70816-2	
70826-1	
70828-5	
70830-8	
70832-2	
72080-5	
72082-9	

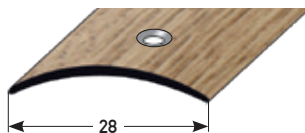

Holzdekor / wood decor	Buche beech	1.0	38160-0	
		2.7	38170-9	
	Eiche oak	1.0	38180-8	
		2.7	38190-7	
	Ahorn maple	1.0	38200-3	
		2.7	38210-2	
	Kirschbaum cherry wood	1.0	38220-1	
		2.7	38225-6	
	Eiche rustikal rustic oak	1.0	38230-0	
		2.7	38235-5	

38161-7	
38171-6	
38181-5	
38191-4	
38201-0	
38211-9	
38221-8	
38226-3	
38231-7	
38236-2	



4. ÜBERGANGSPROFILE / 4. CONNECTING PROFILES

Andere Eloxalfarben siehe Abschnitt 6, Lieferzeit 14 Tage
other anodized colours see section 6, delivery time 14 days

Profi-Pack à 10 Stück im Bund			
professional packing à 10 pcs.			
Farbe/colour	L/l (m)	Art./ref.	€/Stk./pcs.

SB-Pack VE 20 Stk.	
self-service-pack à 20 pcs.	
Art./ref.	€/Stk./pcs.

05 Übergangsprofil 28 x 1,5 mm, Aluminium eloxiert, selbstklebend

connecting profile 28 x 1,5 mm, aluminium anodized, self-adhesive

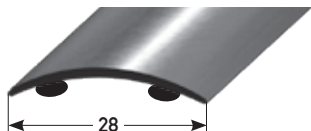

silberfarbig silver	0,9	08493-8	
	1,0	08503-4	
	2,7	08523-2	
goldfarbig gold	0,9	08593-5	
	1,0	08603-1	
	2,7	08623-9	
bronzefarbig hell bronze light	0,9	08693-2	
	1,0	08703-8	
	2,7	08723-6	
bronzefarbig dunkel bronze dark	0,9	08793-9	
	1,0	08803-5	
	2,7	08823-3	
gold hell gold light	0,9	70836-0	
	1,0	70838-4	
	2,7	70840-7	
edelstahlfarbig Feinschliff fine-honed stainless steel, coloured	0,9	70848-3	
	1,0	70850-6	
	2,7	70852-0	
schwarz black	1,0	72084-3	
	2,7	72086-7	

08492-1	
08502-7	
08524-9	
08592-8	
08602-4	
08624-6	
08692-5	
08702-1	
08724-3	
08792-2	
08802-8	
08824-0	
70842-1	
70844-5	
70846-9	
70854-4	
70856-8	
70858-2	
72088-1	
72090-4	

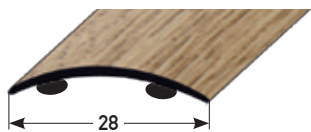

Holzdekor/wood decor	Buche beech	1,0	38100-6	
		2,7	38110-5	
	Eiche oak	1,0	38120-4	
		2,7	38130-3	
	Ahorn maple	1,0	38140-2	
		2,7	38150-1	
	Kirschbaum cherry wood	1,0	38240-9	
		2,7	38245-4	
	Eiche rustikal rustic oak	1,0	38250-8	
		2,7	38255-3	

38101-3	
38111-2	
38121-1	
38131-0	
38141-9	
38151-8	
38241-6	
38246-1	
38251-5	
38256-0	

Beispiel:
oberes Übergangsprofil 28 mm, Nr. 05,
siehe Seite 53 + 54 / unteres Übergangs-
profil 38 mm, Nr. 12, siehe Seite 59 + 60

example:
upper connecting profile 28 mm, no. 05,
see 53 + 54 / lower connecting profile 38 mm,
no. 12, see page 59 + 60



Andere Eloxalfarben siehe Abschnitt 6. Lieferzeit 14 Tage
other anodized colours see section 6. delivery time 14 days

Profi-Pack à 10 Stück im Bund

professional packing à 10 pcs.

Farbe / colour	L / l (m)	Art. / ref.	€/Stk. / pcs.
----------------	-----------	-------------	---------------

SB-Pack incl. Schr. / Dübel: VE 20 Stk.

self-service-pack with screws / dowels: à 20 pcs.

Art. / ref.	€/Stk. / pcs.
-------------	---------------

10 Übergangprofil 24,5 x 1,25 mm, Aluminium eloxiert, mittig gebohrt

connecting profile 24,5 x 1,25 mm
aluminium anodized, centrally drilled

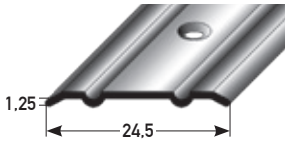

silberfarbig silver	0,9	31105-8	
	1,0	31110-2	
	2,7	31115-7	
goldfarbig gold	0,9	31120-1	
	1,0	31125-6	
	2,7	31130-0	
bronzefarbig hell bronze light	0,9	31135-5	
	1,0	31140-9	
	2,7	31145-4	
bronzefarbig dunkel bronze dark	0,9	31150-8	
	1,0	31155-3	
	2,7	31160-7	

31106-5	
31111-9	
31116-4	
31121-8	
31126-3	
31131-7	
31136-2	
31141-6	
31146-1	
31151-5	
31156-0	
31161-4	

10 Übergangprofil 24,5 x 1,25 mm, Aluminium eloxiert, selbstklebend

connecting profile 24,5 x 1,25 mm
aluminium anodized, self-adhesive

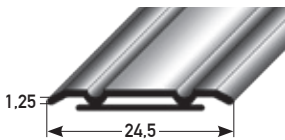

silberfarbig silver	0,9	31107-2	
	1,0	31112-6	
	2,7	31118-8	
goldfarbig gold	0,9	31122-5	
	1,0	31127-0	
	2,7	31133-1	
bronzefarbig hell bronze light	0,9	31137-9	
	1,0	31142-3	
	2,7	31148-5	
bronzefarbig dunkel bronze dark	0,9	31152-2	
	1,0	31157-7	
	2,7	31163-8	

31108-9	
31113-3	
31117-1	
31123-2	
31128-7	
31132-4	
31138-6	
31143-0	
31147-8	
31153-9	
31158-4	
31162-1	

11 Übergangprofil 27 x 1,7 mm, Aluminium eloxiert, mittig gebohrt

connecting profile 27 x 1,7 mm
aluminium anodized, centrally drilled

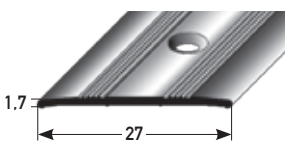

silberfarbig silver	0,9	23090-8	
	1,0	23100-4	
	2,0	23120-2	
	2,7	23110-3	
goldfarbig gold	0,9	23190-5	
	1,0	23200-1	
	2,0	23220-9	
	2,7	23210-0	
bronzefarbig hell bronze light	0,9	23290-2	
	1,0	23300-8	
	2,0	23320-6	
	2,7	23310-7	
bronzefarbig dunkel bronze dark	0,9	23390-9	
	1,0	23400-5	
	2,0	23420-3	
	2,7	23410-4	

23091-5	
23101-1	
23111-0	
23191-2	
23201-8	
23211-7	
23291-9	
23301-5	
23311-4	
23391-6	
23401-2	
23411-1	

11 Übergangprofil 27 x 1,7 mm, Aluminium eloxiert, selbstklebend

connecting profile 27 x 1,7 mm
aluminium anodized, self-adhesive

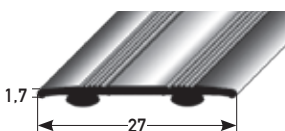

silberfarbig silver	0,9	23093-9	
	1,0	23103-5	
	2,7	23123-3	
goldfarbig gold	0,9	23193-6	
	1,0	23203-2	
	2,7	23223-0	
bronzefarbig hell bronze light	0,9	23293-3	
	1,0	23303-9	
	2,7	23323-7	
bronzefarbig dunkel bronze dark	0,9	23393-0	
	1,0	23403-6	
	2,7	23423-4	

23092-2	
23102-8	
23122-6	
23192-9	
23202-5	
23222-3	
23292-6	
23302-2	
23322-0	
23392-3	
23402-9	
23422-7	



4. ÜBERGANGSPROFILE / 4. CONNECTING PROFILES

Andere Eloxalfarben siehe Abschnitt 6, Lieferzeit 14 Tage
other anodized colours see section 6, delivery time 14 days

Profi-Pack à 10 Stück im Bund

professional packing à 10 pcs.

Farbe/colour	L/l (m)	Art./ref.	€/Stk./pcs.
--------------	---------	-----------	-------------

SB-Pack incl. Schr./Dübel:
VE 20 Stk.

self-service-pack with
screws / dowels; à 20 pcs.

Art./ref.	€/Stk./pcs.
-----------	-------------

06 Stegübergangsprofil 28 x 4,5 mm, Aluminium eloxiert, mittig gebohrt

connecting profile with bars
28 x 4,5 mm, aluminium
anodized, centrally drilled

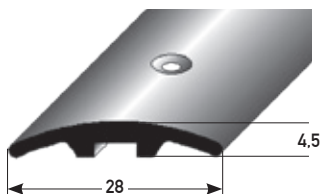

silberfarbig silver	0,9	31205-5	
	1,0	31210-9	
	2,7	31215-4	
goldfarbig gold	0,9	31220-8	
	1,0	31225-3	
	2,7	31230-7	
bronzefarbig hell bronze light	0,9	31235-2	
	1,0	31240-6	
	2,7	31245-1	
bronzefarbig dunkel bronze dark	0,9	31250-5	
	1,0	31255-0	
	2,7	31260-4	

31207-9	
31212-3	
31217-8	
31222-2	
31227-7	
31232-1	
31237-6	
31242-0	
31247-5	
31252-9	
31257-4	
31262-8	

06 Stegübergangsprofil 28 x 4,5 mm, Aluminium eloxiert, selbstklebend

connecting profile with bars
28 x 4,5 mm, aluminium
anodized, self-adhesive

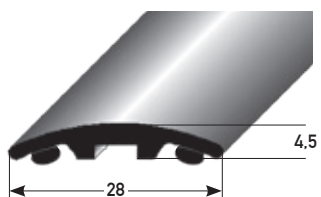

silberfarbig silver	0,9	31206-2	
	1,0	31211-6	
	2,7	31216-1	
goldfarbig gold	0,9	31221-5	
	1,0	31226-0	
	2,7	31231-4	
bronzefarbig hell bronze light	0,9	31236-9	
	1,0	31241-3	
	2,7	31246-8	
bronzefarbig dunkel bronze dark	0,9	31251-2	
	1,0	31256-7	
	2,7	31261-1	

31208-6	
31213-0	
31218-5	
31223-9	
31228-4	
31233-8	
31238-3	
31243-7	
31248-2	
31253-6	
31258-1	
31263-5	



Andere Eloxalfarben siehe Abschnitt 6. Lieferzeit 14 Tage
other anodized colours see section 6. delivery time 14 days

Profi-Pack à 10 Stück im Bund			
professional packing à 10 pcs.			
Farbe/colour	L/l (m)	Art./ref.	€/Stk./pcs.

SB-Pack incl. Schr./Dübel: VE 20 Stk.	
self-service-pack with screws/dowels: à 20 pcs.	
Art./ref.	€/Stk./pcs.

07 Übergangprofil 37 x 4,5 mm, Aluminium eloxiert, mittig gebohrt

connecting profile 37 x 4,5 mm, aluminium anodized, centrally drilled

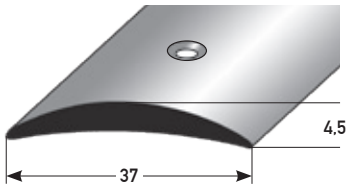

silberfarbig silver	0.9	31305-2	
	1.0	31310-6	
	2.7	31315-1	
goldfarbig gold	0.9	31320-5	
	1.0	31325-0	
	2.7	31330-4	
bronzefarbig hell bronze light	0.9	31335-9	
	1.0	31340-3	
	2.7	31345-8	
bronzefarbig dunkel bronze dark	0.9	31350-2	
	1.0	31355-7	
	2.7	31360-1	

31307-6	
31312-0	
31317-5	
31322-9	
31327-4	
31332-8	
31337-3	
31342-7	
31347-2	
31352-6	
31357-1	
31362-5	

07 Übergangprofil 37 x 4,5 mm, Aluminium eloxiert, seitlich gebohrt

connecting profile 37 x 4,5 mm, aluminium anodized, laterally drilled

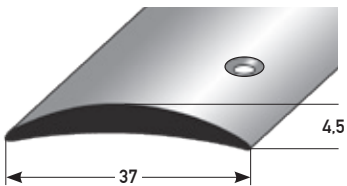

silberfarbig silver	0.9	47700-6	
	1.0	47702-0	
	2.7	47704-4	
goldfarbig gold	0.9	47712-9	
	1.0	47714-3	
	2.7	47716-7	
bronzefarbig hell bronze light	0.9	47724-2	
	1.0	47726-6	
	2.7	47728-0	
bronzefarbig dunkel bronze dark	0.9	47736-5	
	1.0	47738-9	
	2.7	47740-2	

47706-8	
47708-2	
47710-5	
47718-1	
47720-4	
47722-8	
47730-3	
47732-7	
47734-1	
47742-6	
47744-0	
47746-4	

07 Übergangprofil 37 x 4,5 mm, Aluminium eloxiert, selbstklebend

connecting profile 37 x 4,5 mm, aluminium anodized, self-adhesive

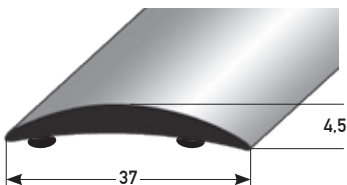

silberfarbig silver	0.9	31306-9	
	1.0	31311-3	
	2.7	31316-8	
goldfarbig gold	0.9	31321-2	
	1.0	31326-7	
	2.7	31331-1	
bronzefarbig hell bronze light	0.9	31336-6	
	1.0	31341-0	
	2.7	31346-5	
bronzefarbig dunkel bronze dark	0.9	31351-9	
	1.0	31356-4	
	2.7	31361-8	

31308-3	
31313-7	
31318-2	
31323-6	
31328-1	
31333-5	
31338-0	
31343-4	
31348-9	
31353-3	
31358-8	
31363-2	

Beispiel: Übergangprofil 37 x 4,5 mm, Aluminium (siehe oben)
example: connecting profile 37 x 4,5 mm, aluminium (see above)

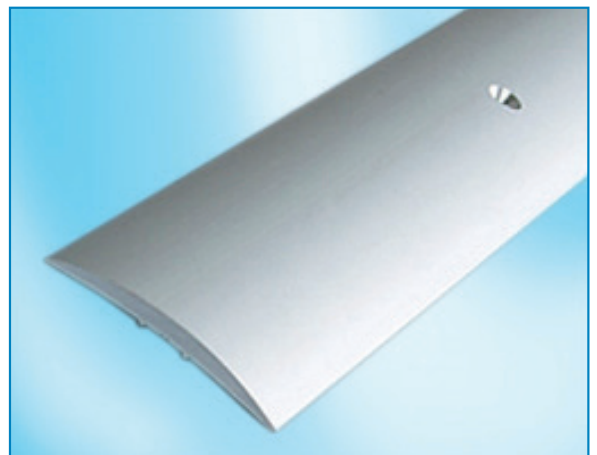

4. ÜBERGANGSPROFILE / 4. CONNECTING PROFILES

seitlich gebohrt, ungebohrt
oder als Flachprofil auf Anfrage
erhältlich
laterally drilled, undrilled or as flat
profile available on demand

02 Übergangsprofil 37 mm, Messing poliert, mit Schutzfolie

connecting profile 37 mm,
brass polished, with protective film

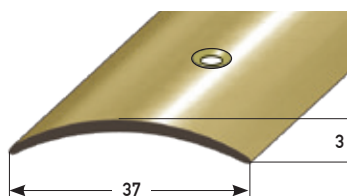

Profi-Pack à 10 Stück im Bund			
professional packing à 10 pcs.			
Dicke + Befestigung thickness + fixing	L/l (m)	Art./ref.	€/Stk./pcs.
1.0 mm	mittig gebohrt centrally drilled	0.9	06090-1
		1.0	06100-7
		2.0	06110-6
	seitlich gebohrt laterally drilled	0.9	06390-2
		1.0	06400-8
		2.0	06410-7
	selbstklebend self-adhesive	0.9	06093-2
		1.0	06103-8
		2.7	06123-6
1.2 mm	mittig gebohrt centrally drilled	0.9	06095-6
		1.0	06105-2
		2.7	06125-0
	seitlich gebohrt laterally drilled	0.9	06094-9
		1.0	06104-5
		2.7	06124-3
	selbstklebend self-adhesive	0.9	06097-0
		1.0	06107-6
		2.7	06127-4

SB-Pack incl. Schr./Dübel: VE 20 Stk.	
self-service-pack with screws/dowels: à 20 pcs.	
Art./ref.	€/Stk./pcs.
06091-8	
06101-4	
06121-2	
06391-9	
06401-5	
06421-3	
06092-5	
06102-1	
06122-9	
06096-3	
06106-9	
06126-7	
06099-4	
06109-0	
06129-8	
06098-7	
06108-3	
06128-1	

15 Übergangsprofil 37 mm, Edelstahl poliert, mit Schutzfolie

connecting profile 37 mm, stainless
steel polished, with protective film

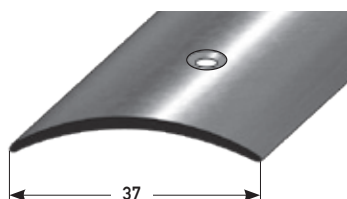

1.0 mm	mittig gebohrt centrally drilled	0.9	06190-8
		1.0	06200-4
		2.0	06210-3
	seitlich gebohrt laterally drilled	0.9	06490-9
		1.0	06500-5
		2.0	06510-4
selbstklebend self-adhesive	0.9	06193-9	
	1.0	06203-5	
	2.7	06223-3	
1.5 mm	mittig gebohrt centrally drilled	1.0	42490-1
		2.7	42500-7
	selbstklebend self-adhesive	1.0	42520-5
2.0 mm	mittig gebohrt centrally drilled	1.0	42550-2
		2.7	42560-1
	selbstklebend self-adhesive	1.0	42580-9
		2.7	42590-8

06191-5	
06201-1	
06221-9	
06491-6	
06501-2	
06521-0	
06192-2	
06202-8	
06222-6	
42491-8	
42501-4	
42521-2	
42531-1	
42551-9	
42561-8	
42581-6	
42591-5	

16 Übergangsprofil 37 mm, Edelstahl matt, mit Schutzfolie

connecting profile 37 mm, stainless
steel matt, with protective film

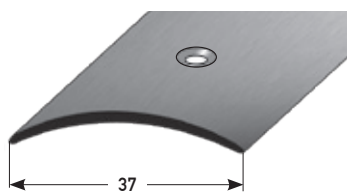

1.0 mm	mittig gebohrt centrally drilled	0.9	06690-3
		1.0	06700-9
		2.7	06720-7
	seitlich gebohrt laterally drilled	0.9	06790-0
		1.0	06800-6
		2.7	06820-4
selbstklebend self-adhesive	0.9	06890-7	
	1.0	06900-3	
	2.7	06920-1	
1.5 mm	mittig gebohrt centrally drilled	1.0	60025-1
		2.7	42600-4
	selbstklebend self-adhesive	1.0	42610-3
2.0 mm	mittig gebohrt centrally drilled	1.0	60545-4
		2.7	42640-0
	selbstklebend self-adhesive	1.0	42650-9
		2.7	42670-7

06691-0	
06701-6	
06721-4	
06791-7	
06801-3	
06821-1	
06891-4	
06901-0	
06921-8	
42601-1	
42603-5	
42611-0	
42631-8	
42641-7	
42643-1	
42651-6	
42671-4	



Andere Eloxalfarben siehe Abschnitt 6. Lieferzeit 14 Tage
other anodized colours see section 6. delivery time 14 days

Profi-Pack à 10 Stück im Bund			
professional packing à 10 pcs.			
Farbe/colour	L/l (m)	Art./ref.	€/Stk./pcs.

SB-Pack incl. Schr./Dübel, VE 20 Stk.	
self-service-pack with screws/dowels; à 20 pcs.	
Art./ref.	€/Stk./pcs.

12 Übergangprofil 38 x 1,8 mm, Aluminium eloxiert, gebohrt

connecting profile 38 x 1.8 mm, aluminium anodized, drilled

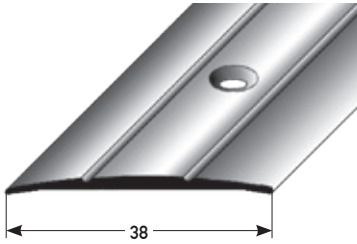

silberfarbig silver	0.9	23490-6	
	1.0	23500-2	
	2.0	23510-1	
	2.7	23520-0	
goldfarbig gold	0.9	23590-3	
	1.0	23600-9	
	2.0	23610-8	
	2.7	23620-7	
bronzefarbig hell bronze light	0.9	23690-0	
	1.0	23700-6	
	2.0	23710-5	
bronzefarbig dunkel bronze dark	0.9	23790-7	
	1.0	23800-3	
	2.0	23810-2	
edelstahlfarbig Feinschliff fine-honed stainless steel coloured	0.9	71930-4	
	1.0	71932-8	
	2.7	71934-2	
schwarz black	1.0	72094-2	
	2.7	72096-6	

23491-3	
23501-9	
23521-7	
23591-0	
23601-6	
23621-4	
23691-7	
23701-3	
23721-1	
23791-4	
23801-0	
23821-8	
71936-6	
71938-0	
71940-3	
72098-0	
72100-0	

Holzdekor / wood decor			
	1.0	2.7	
Buche beech	1.0	38340-6	
	2.7	38350-5	
Eiche oak	1.0	38360-4	
	2.7	38370-3	
Ahorn maple	1.0	38380-2	
	2.7	38390-1	
Kirschbaum cherry wood	1.0	38400-7	
	2.7	38405-2	
Eiche rustikal rustic oak	1.0	38410-6	
	2.7	38415-1	

38341-3	
38351-2	
38361-1	
38371-0	
38381-9	
38391-8	
38401-4	
38406-9	
38411-3	
38416-8	



4. ÜBERGANGSPROFILE / 4. CONNECTING PROFILES

Andere Eloxalfarben siehe Abschnitt 6, Lieferzeit 14 Tage
other anodized colours see section 6, delivery time 14 days

Profi-Pack à 10 Stück im Bund			
professional packing à 10 pcs.			
Farbe / colour	L/l (m)	Art./ref.	€/Stk./pcs.

SB-Pack, VE 20 Stk.	
self-service-pack, à 20 pcs.	
Art./ref.	€/Stk./pcs.

12 Übergangprofil 38 x 1,8 mm, Aluminium eloxiert, selbstklebend

connecting profile 38 x 1,8 mm
aluminium anodized, self-adhesive

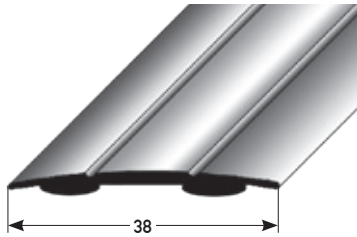

silberfarbig silver	0.9	23493-7	
	1.0	23503-3	
	2.7	23523-1	
goldfarbig gold	0.9	23593-4	
	1.0	23603-0	
	2.7	23623-8	
bronzefarbig hell bronze light	0.9	23693-1	
	1.0	23703-7	
	2.7	23723-5	
bronzefarbig dunkel bronze dark	0.9	23793-8	
	1.0	23803-4	
	2.7	23823-2	
edelstahlfarbig Feinschliff fine-honed stainless steel coloured	0.9	71942-7	
	1.0	71944-1	
	2.7	71946-5	
schwarz black	1.0	72102-4	
	2.7	72104-8	

23492-0	
23502-6	
23522-4	
23592-7	
23602-3	
23622-1	
23692-4	
23702-0	
23722-8	
23792-1	
23802-7	
23822-5	
71948-9	
68004-8	
68006-2	
72106-2	
72108-6	

Holzdekor/wood decor	Buche beech	1.0	38280-5	
		2.7	38290-4	
	Eiche oak	1.0	38300-0	
		2.7	38310-9	
	Ahorn maple	1.0	38320-8	
		2.7	38330-7	
	Kirschbaum cherry wood	1.0	38420-5	
		2.7	38425-0	
	Eiche rustikal rustic oak	1.0	38430-4	
		2.7	38435-9	

38281-2	
38291-1	
38301-7	
38311-6	
38321-5	
38331-4	
38421-2	
38426-7	
38431-1	
38436-6	

Andere Eloxalfarben siehe Abschnitt 6. Lieferzeit 14 Tage
other anodized colours see section 6. delivery time 14 days

Profi-Pack à 10 Stück im Bund			
professional packing à 10 pcs.			
Befestigung / fixing	L / l (m)	Art. / ref.	€ / Stk. / pcs.

SB-Pack incl. Schr. / Dübel: VE 20 Stk.	
self-service-pack with screws / dowels: à 20 pcs.	
Art. / ref.	€ / Stk. / pcs.

03 Übergangsprofil 48 x 2 mm, Messing poliert

connecting profile 48 x 2 mm, brass polished

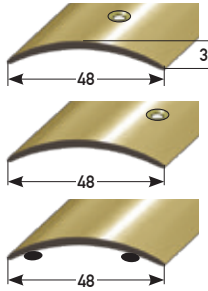

mittig gebohrt centrally drilled	1.0	28761-2	
	2.5	28760-5	
seitlich gebohrt laterally drilled	1.0	48060-0	
	2.5	48062-4	
selbstklebend self-adhesive	1.0	48070-9	
	2.5	48072-3	

28763-6	
28762-9	
48064-8	
48066-2	
48074-7	
48076-1	

Bitte fordern Sie unsere Pflegehinweise für Messingprofile an!
Please ask for our care tips for brass profiles!

155 Übergangsprofil 50 x 1,5 mm, Edelstahl matt, gewölbt, mit Schutzfolie

connecting profile 50 x 1,5 mm, stainless steel matt, curved, with protective film

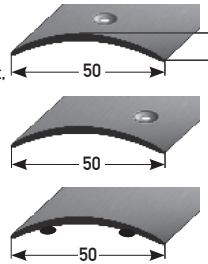

mittig gebohrt centrally drilled	1.0	63000-5	
	2.7	63005-0	
seitlich gebohrt laterally drilled	1.0	63020-3	
	2.7	63025-8	
selbstklebend self-adhesive	1.0	63040-1	
	2.7	63045-6	

63010-4	
63015-9	
63030-2	
63035-7	
63050-0	
63055-5	

145 Übergangsprofil 50 x 4 mm, Aluminium eloxiert, mittig gebohrt, für starke Belastungen

connecting profile 50 x 4 mm, aluminium anodized, heavy duty, centrally drilled

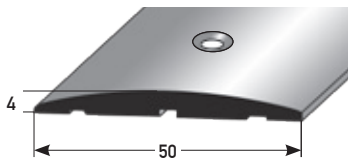

Farbe / colour			
silberfarbig silver	1.0	42820-6	
	2.7	42825-1	
goldfarbig gold	1.0	42840-4	
	2.7	42845-9	
bronzefarbig hell bronze light	1.0	42860-2	
	2.7	42865-7	
bronzefarbig dunkel bronze dark	1.0	42880-0	
	2.7	42885-5	

42830-5	
42835-0	
42850-3	
42855-8	
42870-1	
42875-6	
42890-9	
42895-4	

145 Übergangsprofil 50 x 4 mm, Aluminium eloxiert, seitlich gebohrt, für starke Belastungen

connecting profile 50 x 4 mm, aluminium anodized, heavy duty, laterally drilled

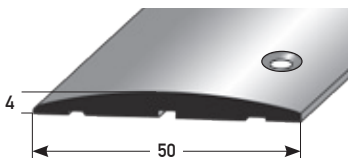

silberfarbig silver	1.0	47818-8	
	2.7	47820-1	
goldfarbig gold	1.0	47826-3	
	2.7	47828-7	
bronzefarbig hell bronze light	1.0	47834-8	
	2.7	47836-2	
bronzefarbig dunkel bronze dark	1.0	47842-3	
	2.7	47844-7	

47822-5	
47824-9	
47830-0	
47832-4	
47838-6	
47840-9	
47846-1	
47848-5	

145 Übergangsprofil 50 x 4 mm, Aluminium eloxiert, selbstklebend, für starke Belastungen

connecting profile 50 x 4 mm, aluminium anodized, heavy duty, self-adhesive

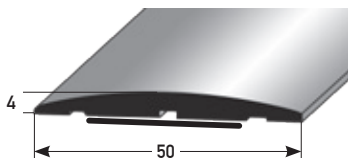

silberfarbig silver	1.0	47750-1	
	2.7	47752-5	
goldfarbig gold	1.0	47758-7	
	2.7	47760-0	
bronzefarbig hell bronze light	1.0	47766-2	
	2.7	47768-6	
bronzefarbig dunkel bronze dark	1.0	47774-7	
	2.7	47776-1	

47754-9	
47756-3	
47762-4	
47764-8	
47770-9	
47772-3	
47778-5	
47780-8	



4. ÜBERGANGSPROFILE / 4. CONNECTING PROFILES

Andere Eloxalfarben siehe Abschnitt 6, Lieferzeit 14 Tage
other anodized colours see section 6, delivery time 14 days

Profi-Pack à 10 Stück im Bund			
professional packing à 10 pcs.			
Farbe / colour	L / l (m)	Art. / ref.	€/Stk. / pcs.

SB-Pack incl. Schr. / Dübel: VE 20 Stk.	
self-service-pack with screws / dowels; à 20 pcs.	
Art. / ref.	€/Stk. / pcs.

04 Übergangprofil 57 x 2 mm, Messing poliert

connecting profile 57 x 2 mm, brass polished

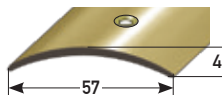

mittig gebohrt centrally drilled	1.0	28771-1			
	2.5	28770-4			

28773-5	
28772-8	

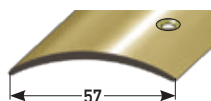

seitlich gebohrt laterally drilled	1.0	48080-8			
	2.5	48082-2			

48084-6	
48086-0	

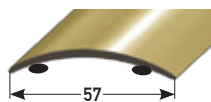

selbstklebend self-adhesive	1.0	48090-7			
	2.5	48092-1			

48094-5	
48096-9	

Bitte fordern Sie unsere Pflegehinweise für Messingprofile an!
Please ask for our care tips for brass profiles!

08 Übergangprofil 58 x 4 mm, Aluminium eloxiert, mittig gebohrt, für starke Belastungen

connecting profile 58 x 4 mm, aluminium anodized, heavy duty, centrally drilled

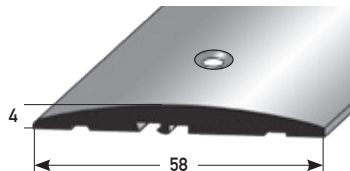

Farbe / colour					
silberfarbig silver	1.0	31600-8			
	2.7	31605-3			
goldfarbig gold	1.0	31610-7			
	2.7	31615-2			
bronzefarbig hell bronze light	1.0	31620-6			
	2.7	31625-1			
bronzefarbig dunkel bronze dark	1.0	31630-5			
	2.7	31635-0			

31601-5	
31606-0	
31611-4	
31616-9	
31621-3	
31626-8	
31631-2	
31636-7	

08 Übergangprofil 58 x 4 mm, Aluminium eloxiert, seitlich gebohrt, für starke Belastungen

connecting profile 58 x 4 mm, aluminium anodized, heavy duty, laterally drilled

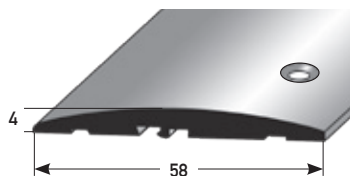

silberfarbig silver	1.0	47852-2			
	2.7	47854-6			
goldfarbig gold	1.0	47860-7			
	2.7	47862-1			
bronzefarbig hell bronze light	1.0	47868-3			
	2.7	47870-6			
bronzefarbig dunkel bronze dark	1.0	47876-8			
	2.7	47878-2			

47856-0	
47858-4	
47864-5	
47866-9	
47872-0	
47874-4	
47880-5	
47882-9	

08 Übergangprofil 58 x 4 mm, Aluminium eloxiert, selbstklebend, für starke Belastungen

connecting profile 58 x 4 mm, aluminium anodized, heavy duty, self-adhesive

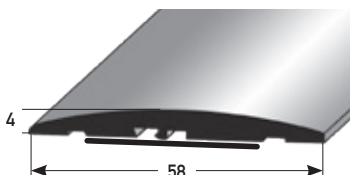

silberfarbig silver	1.0	47784-6			
	2.7	47786-0			
goldfarbig gold	1.0	47792-1			
	2.7	47794-5			
bronzefarbig hell bronze light	1.0	47800-3			
	2.7	47802-7			
bronzefarbig dunkel bronze dark	1.0	47808-9			
	2.7	47810-2			

47788-4	
47790-7	
47796-9	
47798-3	
47804-1	
47806-5	
47812-6	
47814-0	



Andere Eloxalfarben siehe Abschnitt 6. Lieferzeit 14 Tage
other anodized colours see section 6. delivery time 14 days

Profi-Pack à 10 Stück im Bund

professional packing à 10 pcs.

Farbe / colour	L / l (m)	Art. / ref.	€ / Stk. / pcs.
----------------	-----------	-------------	-----------------

SB-Pack incl. Schr. / Dübel: VE 20 Stk.

self-service-pack with screws / dowels: à 20 pcs.

Art. / ref.	€ / Stk. / pcs.
-------------	-----------------

350 Übergangsprofil 80 x 3,5 mm, Aluminium eloxiert, mittig gebohrt

connecting profile 80 x 3,5 mm, aluminium anodized, centrally drilled

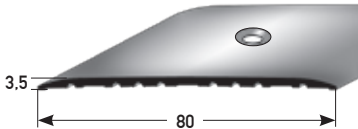

silberfarbig silver	1.0	65400-1	
	2.7	65402-5	
goldfarbig gold	1.0	65404-9	
	2.7	65406-3	
bronzefarbig hell bronze light	1.0	65408-7	
	2.7	65410-0	
bronzefarbig dunkel bronze dark	1.0	65412-4	
	2.7	65414-8	

65416-2	
65418-6	
65420-9	
65422-3	
65424-7	
65426-1	
65428-5	
65430-8	

350 Übergangsprofil 80 x 3,5 mm, Aluminium eloxiert, seitlich gebohrt

connecting profile 80 x 3,5 mm, aluminium anodized, laterally drilled

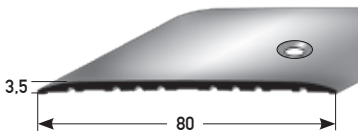

silberfarbig silver	1.0	65434-6	
	2.7	65436-0	
goldfarbig gold	1.0	65438-4	
	2.7	65440-7	
bronzefarbig hell bronze light	1.0	65442-1	
	2.7	65444-5	
bronzefarbig dunkel bronze dark	1.0	65446-9	
	2.7	65448-3	

65450-6	
65452-0	
65454-4	
65456-8	
65458-2	
65460-5	
65462-9	
65464-3	

350 Übergangsprofil 80 x 3,5 mm, Aluminium eloxiert, selbstklebend

connecting profile 80 x 3,5 mm, aluminium anodized, self-adhesive

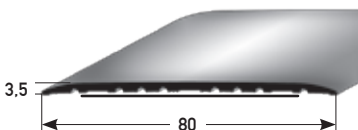

silberfarbig silver	1.0	65468-1	
	2.7	65470-4	
goldfarbig gold	1.0	65472-8	
	2.7	65474-2	
bronzefarbig hell bronze light	1.0	65476-6	
	2.7	65478-0	
bronzefarbig dunkel bronze dark	1.0	65480-3	
	2.7	65482-7	

65484-1	
65486-5	
65488-9	
65490-2	
65492-6	
65494-0	
65496-4	
65498-8	

wechselseitig gebohrt auf Anfrage
alternating sides drilled on request



Profi-Pack à 10 Stück im Bund

professional packing à 10 pcs.

Farbe/colour	L/l (m)	Art./ref.	€/Stk./pcs.
--------------	---------	-----------	-------------

SB-Pack incl. Schr./Dübel:
VE 20 Stk.

self-service-pack with
screws/dowels; à 20 pcs.

Art./ref.	€/Stk./pcs.
-----------	-------------

439 Edelstahl-Übergangprofil 27 x 1,5 mm, profilierte Riffelung, matt

stainless steel
connecting profile
27 x 1,5 mm,
fluted profile
matt

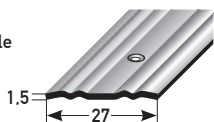

mittig gebohrt centrally	1.0	68270-7		68282-0	
	2.7	68272-1		68284-4	

selbstklebend self-adhesive	1.0	68276-9		68288-2	
	2.7	68278-3		68290-5	

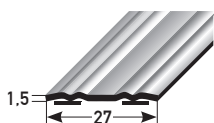

440 Edelstahl-Übergangprofil 38 x 1,5 mm, profilierte Riffelung, matt

stainless steel
connecting profile
38 x 1,5 mm,
fluted profile,
matt

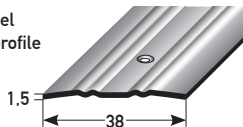

mittig gebohrt centrally	1.0	68300-1		68312-4	
	2.7	68302-5		68314-8	

selbstklebend self-adhesive	1.0	68306-3		68318-6	
	2.7	68308-7		68320-9	

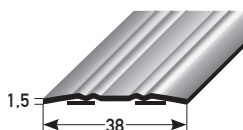

441 Übergangprofil 30 x 3,5 mm, Edelstahl V4A gezogen, gebohrt

drawn stainless steel
connecting profile
V4A 30 x 3,5 mm,
drilled

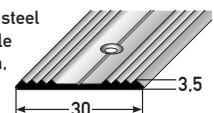

mittig gebohrt centrally drilled	1.0	68330-8		68336-0	
	2.5	68332-2		68338-4	

Edelstahlschrauben siehe
Abschnitt 12/
stainless steel screws see
section 12

Edelstahl-Übergangprofile INOX PROTECT zur Verlegung mit Einlage 39 mm

stainless steel connecting profiles for installation with insert 39 mm

L/l (m)	VE/unit	Art./ref.	€/Stk./pcs.
---------	---------	-----------	-------------

412 Übergangprofil 70 x 1,5 mm INOX Protect, Edelstahl matt, gebohrt

connecting profile 70 x 1,5 mm
INOX PROTECT, stainless steel matt,
drilled

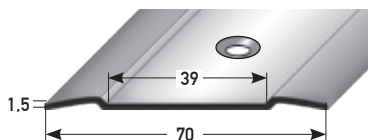

für Verlegung mit Einlage 39 mm, siehe Seite 23
for installation with insert 39 mm, see page 23

1,0 m	1 Stück/pcs.	67034-6	
2,5 m		67036-0	
3,0 m		67038-4	

**3,0 m-Ware ist nur per Spedition lieferbar
(gesonderte Transportkosten)**
3,0 m profiles are only available per forwarding agency
(separate transport costs)

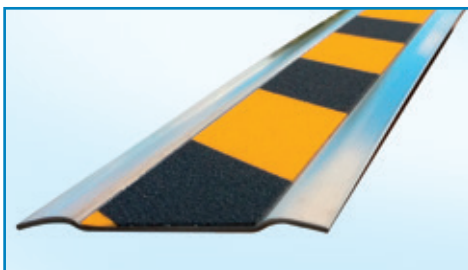

Übergangprofil INOX PROTECT mit Einlage 39 mm,
Easy-Clean, gelb-schwarz (siehe oben bzw. Seite
23) connecting profile INOX PROTECT with insert 39 mm,
Easy-Clean, yellow-black (see above and page 23)



Andere Abmaße auf Anfrage
other dimensions on demand

gekantete Übergangprofile aus Edelstahl, matt gebürstet					
edged connecting profiles, stainless steel matt brushed					
Breite/width (mm)	L/l (m)	1.5 mm Materialstärke / thickness		2.0 mm Materialstärke / thickness	
		Art./ref.	€/Stk./pcs.	Art./ref.	€/Stk./pcs.

Übergangsprofil 1,5/2,0/3,0 mm, Edelstahl matt, gekantet

250

136

connecting profile 1.5/2.0/3.0 mm,
stainless steel matt, edged

50 mm	1.00	60045-9		60560-7	
	1.25	60050-3		60565-2	
	2.50	60060-2		60570-6	
60 mm	1.00	60065-7		60575-1	
	1.25	60070-1		60580-5	
	2.50	60080-0		60585-0	
70 mm	1.00	60085-5		60590-4	
	1.25	60090-9		60595-9	
	2.50	60100-5		60600-0	
80 mm	1.00	60105-0		60605-5	
	1.25	60110-4		60610-9	
	2.50	60120-3		60615-4	
100 mm	1.00	60125-8		60620-8	
	1.25	60130-2		60625-3	
	2.50	60140-1		60630-7	

* Bitte Befestigungstyp angeben:

- 01 mittig gebohrt
- 02 seitlich gebohrt
- 03 wechselseitig gebohrt
- 04 ungebohrt
- 05 selbstklebend

Please specify fixing:

- 01 drilled centrally
- 02 drilled laterally
- 03 alternating sides drilled
- 04 undrilled
- 05 self-adhesive

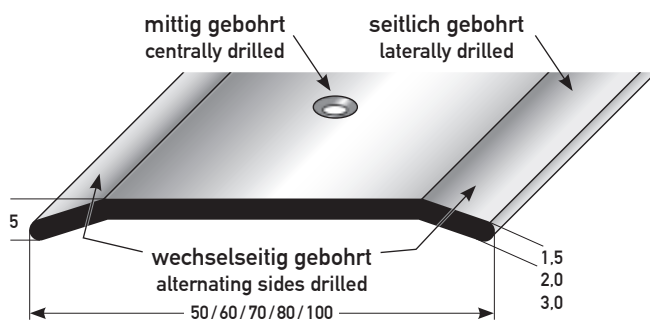

Breite/width (mm)	L/l (m)	3.0 mm Materialstärke / thickness	
		Art./ref.	€/Stk./pcs.

60 mm	1.00	60700-7	
	1.25	60705-2	
	2.50	60710-6	
70 mm	1.00	60715-1	
	1.25	60720-5	
	2.50	60725-0	
80 mm	1.00	60730-4	
	1.25	60735-9	
	2.50	60740-3	
100 mm	1.00	60745-8	
	1.25	60750-2	
	2.50	60755-7	

Bohrungen bis 2 mm Stärke für 3,5 mm Schrauben;
Bohrungen bis 3 mm Stärke für 4 mm Schrauben
holes up to 2 mm thickness for 3.5 mm screws;
drilling at 3 mm for 4 mm screws

Edelstahlschrauben siehe Abschnitt 12
stainless steel screws see section 12



4. ÜBERGANGSPROFILE / 4. CONNECTING PROFILES

Andere Abmaße auf Anfrage
other dimensions on demand

Aluminium-Flachschwellen

Breite / width	Farbe / colour	A x B mm	L / l (m)	gebohrt / drilled	€/m	ohne alles / bare	€/m
----------------	----------------	----------	-----------	-------------------	-----	-------------------	-----

Flachprofil 1,0/2,0/3,0/5,0 mm, Aluminium

flat threshold 1.0/2.0/3.0/5.0 mm.
aluminium

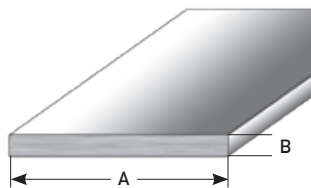

40 mm	silber elox. silver anodized	457	40 x 1.0	2.5	68744-3		68752-8
		538	40 x 2.0	2.5	68746-7		68754-2
		539	40 x 3.0	2.5*	68748-1		68756-6
	edelstahl- farbig stainless steel coloured		40 x 1.0	2.5*	68768-9		68776-4
			40 x 2.0	2.5*	68770-2		68778-8
			40 x 3.0	2.5*	68772-6		68780-1

Seitlich oder wechselseitig
gebohrt auf Anfrage.

Laterally or alternately drilled on
request.

50 mm	silber elox. silver anodized	458	50 x 1.0	2.5	68816-7		68824-2
		540	50 x 2.0	2.5	68818-1		68826-6
		541	50 x 3.0	2.5*	68820-4		68828-0
	edelstahl- farbig stainless steel coloured		50 x 1.0	2.5*	68840-2		68848-8
			50 x 2.0	2.5*	68842-6		68850-1
			50 x 3.0	2.5*	68844-0		68852-5

* inklusive 40 mm Klemm-
stelle an einer Seite vom
Eloxieren /

including 40 mm clamping point on
one side by anodizing

60 mm	silber elox. silver anodized	298	60 x 1.0	2.5	61924-6		61930-7
		428	60 x 2.0	2.5	67246-3		67252-4
		299	60 x 3.0	2.5*	61944-4		61950-5
		300	60 x 5.0	3,0*	61964-2		61970-3
	edelstahl- farbig stainless steel coloured		60 x 1.0	2.5	61926-0		61932-1
			60 x 2.0	2.5	67248-7		67254-8
			60 x 3.0	2.5*	61946-8		61952-9
			60 x 5.0	3,0*	61966-6		61972-7

80 mm	silber elox. silver anodized	542	80 x 1.0	2.5	68888-4		68896-9
		543	80 x 2.0	2.5	68890-7		68898-3
		544	80 x 3.0	2.5*	68892-1		68900-3
	edelstahl- farbig stainless steel coloured		80 x 1.0	2.5*	68912-6		68920-1
			80 x 2.0	2.5*	68914-0		68922-5
			80 x 3.0	2.5*	68916-4		68924-9

100 mm	silber elox. silver anodized	545	100 x 1.0	2.5	68960-7		68968-3
		546	100 x 2.0	2.5	68962-1		68970-6
		547	100 x 3.0	2.5*	68964-5		68972-0
	edelstahl- farbig stainless steel coloured		100 x 1.0	2.5*	68984-3		68992-8
			100 x 2.0	2.5*	68986-7		68994-2
			100 x 3.0	2.5*	68988-1		68996-6

3,0 m-Ware ist nur per Spedition lieferbar (gesonderte Transportkosten)
3.0 m profiles are only available per forwarding agency (separate transport costs)

Andere Abmaße auf Anfrage
other dimensions on demand

Flachprofile / Flachswellen aus Edelstahl matt gebürstet						
flat thresholds out of stainless steel matt brushed						
Breite / width A (mm)	L / l (m)	B = 1,0 mm Materialstärke / thickness			B = 1,5 mm Materialstärke / thickness	
		Koffernr. case no.	Art. / ref.	€/Stk. / pcs.	Koffernr. case no.	Art. / ref.

413 Flachprofil/ Flachselle 1,0/1,5/2,0/3,0/5,0 mm, Edelstahl matt

flathreshold 1,0/ 1,5/ 2,0/ 3,0/ 5,0 mm.
stainless steel matt

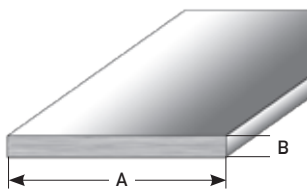

* Bitte Befestigungstyp angeben:

- 01 mittig gebohrt
- 02 seitlich gebohrt
- 03 wechselseitig gebohrt
- 04 ungebohrt
- 05 selbstklebend

Please specify fixing:
01 drilled centrally
02 drilled laterally
03 alternating sides drilled
04 undrilled
05 self-adhesive

30 mm	1,00	548	72648-7	549	72660-9
	2,50		72650-0		72662-3
35 mm	1,00	550	72652-4	551	72664-7
	2,50		72654-8		72666-1
40 mm	1,00	442	68350-6	443	68362-9
	2,50		68352-0		68364-3
45 mm	1,00	552	72656-2	553	72668-5
	2,50		72658-6		72670-8
50 mm	1,00	285	67420-7	288	67442-9
	2,50		61892-8		61906-2
60 mm	1,00	286	67422-1	289	67444-3
	2,50		61894-2		61908-6
70 mm	1,00	414	67424-5	416	67446-7
	2,50		67426-9		67448-1
80 mm	1,00	287	67428-3	290	67450-4
	2,50		61896-6		61910-9
100 mm	1,00	415	67430-6	291	67452-8
	2,50		67432-0		61912-3

Breite / width A (mm)	L / l (m)	B = 2,0 mm Materialstärke / thickness			B = 3,0 mm Materialstärke / thickness	
		Koffernr. case no.	Art. / ref.	€/Stk. / pcs.	Koffernr. case no.	Art. / ref.

30 mm	1,00	554	72672-2	555	72684-5
	2,50		72674-6		72686-9
35 mm	1,00	556	72676-0	557	72688-3
	2,50		72678-4		72690-6
40 mm	1,00	444	68374-2	445	68386-5
	2,50		68376-6		68388-9
45 mm	1,00	558	72680-7	559	72692-0
	2,50		72682-1		72694-4
50 mm	1,00	417	67464-1	422	67496-2
	2,50		67466-5		67498-6
60 mm	1,00	418	67468-9	423	67500-6
	2,50		67470-2		67502-0
70 mm	1,00	419	67472-6	424	67504-4
	2,50		67474-0		67506-8
80 mm	1,00	420	67476-4	425	67508-2
	2,50		67478-8		67510-5
100 mm	1,00	421	67480-1	426	67512-9
	2,50		67482-5		67514-3

Bohrungen bis 2 mm Stärke für
3,5 mm Schrauben;
Bohrungen bei 3-5 mm Stärke
für 4 mm Schrauben

hole up to 2 mm thickness for 3,5 mm
screws; drilling at 3-5 mm for 4 mm
screws

4. ÜBERGANGSPROFILE / 4. CONNECTING PROFILES

Andere Abmaße auf Anfrage
other dimensions on demand

413 Flachprofil/Flachschwelle 5.0 mm, Edelstahl matt

flat profile 5.0 mm.
stainless steel matt

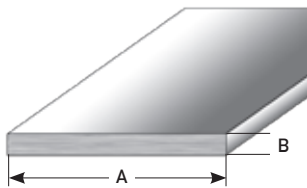

* Bitte Befestigungstyp angeben:

- 01 mittig gebohrt
- 02 seitlich gebohrt
- 03 wechselseitig gebohrt
- 04 ungebohrt
- 05 selbstklebend

Please specify fixing:
01 drilled centrally
02 drilled laterally
03 alternating sides drilled
04 undrilled
05 self-adhesive

Bohrungen bei 3 - 5 mm
Stärke für 4 mm Schrauben
drilling at 3 - 5 mm for 4 mm screws

Flachprofile/Flachschwellen aus Edelstahl, matt gebürstet

flat threshold out of stainless steel matt brushed

Breite / width A (mm)	L / l (m)	B = 5,0 mm Materialstärke / thickness		
		Koffernr. case no.	Art. / ref.	€/Stk. / pcs.

30 mm	1,00	560	72596-1	
	2,50		72598-5	
35 mm	1,00	561	72600-5	
	2,50		72602-9	
40 mm	1,00	562	72604-3	
	2,50		72606-7	
45 mm	1,00	563	72608-1	
	2,50		72610-4	
50 mm	1,00	564	72612-8	
	2,50		72614-2	
60 mm	1,00	565	72616-6	
	2,50		72618-0	

Andere Abmaße auf Anfrage
other dimensions on demand

Verbundschwelle, ungebohrt

composite threshold, undrilled

Deckprofil Edelstahl matt verklebt mit Grundkonstruktion
Aluminium pressblank
cover profile out of matt stainless steel glued to basic construction
aluminium mill finish

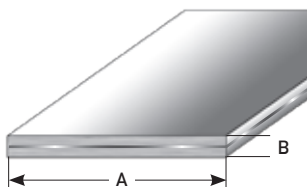

Verbundschwellen Edelstahl – Aluminium

composite threshold stainless steel – aluminium

Breite / width A (mm)	L / l (m)	B = 5,0 mm Materialstärke / thickness		B = 8,0 mm Materialstärke / thickness	
		Art. / ref.	€/Stk. / pcs.	Art. / ref.	€/Stk. / pcs.

40 mm	1,00	72622-7		72626-5	
	2,50	72624-1		72628-9	
50 mm	1,00	72630-2		72634-0	
	2,50	72632-6		72636-4	
60 mm	1,00	72638-8		72642-5	
	2,50	72640-1		72644-9	

Andere Befestigungstypen (gebohrt, selbstklebend, ...) sowie ausgeklinkte Version auf Anfrage erhältlich.

Other fastening types (drilled, self-adhesive, ...) as well as notched version available on request.

Lieferzeit nach Absprache
delivery time after consultation

Andere Eloxalfarben siehe Abschnitt 6. Lieferzeit 14 Tage
other anodized colours see section 6. delivery time 14 days

Profi-Pack à 10 Stück im Bund			
professional packing à 10 pcs.			
Farbe / colour	L / l (m)	Art. / ref.	€ / Stk. / pcs.

SB-Pack incl. Schr. / Dübel: VE 20 Stk.	
self-service-pack with screws / dowels: à 20 pcs.	
Art. / ref.	€ / Stk. / pcs.

09 Abschlussprofil 30 x 4,5 mm, Aluminium eloxiert, gebohrt

adaption profile 30 x 4,5 mm, aluminium anodized, drilled

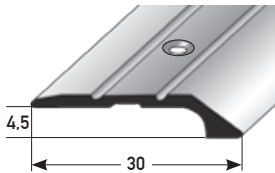

silberfarbig silver	0,9	08090-9	
	1,0	08100-5	
	2,7	08110-4	
goldfarbig gold	0,9	08190-6	
	1,0	08200-2	
	2,7	08210-1	
bronzefarbig hell bronze light	0,9	08290-3	
	1,0	08300-9	
	2,7	08310-8	
bronzefarbig dunkel bronze dark	0,9	08390-0	
	1,0	08400-6	
	2,7	08410-5	

08091-6	
08101-2	
08111-1	
08191-3	
08201-9	
08211-8	
08291-0	
08301-6	
08311-5	
08391-7	
08401-3	
08411-2	

09 Abschlussprofil 30 x 4,5 mm, Aluminium eloxiert, selbstklebend

adaption profile 30 x 4,5 mm, aluminium anodized, self-adhesive

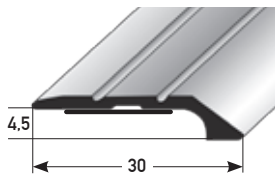

silberfarbig silver	0,9	08093-0	
	1,0	08103-6	
	2,7	08113-5	
goldfarbig gold	0,9	08193-7	
	1,0	08203-3	
	2,7	08213-2	
bronzefarbig hell bronze light	0,9	08293-4	
	1,0	08303-0	
	2,7	08313-9	
bronzefarbig dunkel bronze dark	0,9	08393-1	
	1,0	08403-7	
	2,7	08413-6	

08092-3	
08102-9	
08112-8	
08192-0	
08202-6	
08212-5	
08292-7	
08302-3	
08312-2	
08392-4	
08402-0	
08412-9	

349 Anpassungsprofil 40 mm, Höhengleich 2 bis 16 mm, Aluminium eloxiert, gebohrt

levelling profile 40 mm, height compensation 2-16 mm, aluminium anodized, drilled



silberfarbig silver	1,0	66116-0	
	2,7	66118-4	
goldfarbig gold	1,0	66120-7	
	2,7	66122-1	
bronzefarbig hell bronze light	1,0	66124-5	
	2,7	66126-9	
bronzefarbig dunkel bronze dark	1,0	66128-3	
	2,7	66130-6	

66136-8	
66138-2	
66140-5	
66142-9	
66144-3	
66146-7	
66148-1	
66150-4	

349 Anpassungsprofil 40 mm, Höhengleich 2 bis 16 mm, Aluminium eloxiert, selbstklebend

levelling profile 40 mm, height compensation 2-16 mm, aluminium anodized, self-adhesive



silberfarbig silver	1,0	66158-0	
	2,7	66160-3	
goldfarbig gold	1,0	66162-7	
	2,7	66164-1	
bronzefarbig hell bronze light	1,0	66166-5	
	2,7	66168-9	
bronzefarbig dunkel bronze dark	1,0	66170-2	
	2,7	66172-6	

66178-8	
66180-1	
66182-5	
66184-9	
66186-3	
66188-7	
66190-0	
66192-4	



4. ÜBERGANGSPROFILE / 4. CONNECTING PROFILES

Andere Eloxalfarben siehe Abschnitt 6, Lieferzeit 14 Tage
other anodized colours see section 6, delivery time 14 days

Profi-Pack à 10 Stück im Bund			
professional packing à 10 pcs.			
Farbe/colour	L/l (m)	Art./ref.	€/Stk./pcs.

SB-Pack incl. Schr./Dübel: VE 20 Stk.	
self-service-pack with screws/dowels; à 20 pcs.	
Art./ref.	€/Stk./pcs.

132 Abschlussprofil für Laminat, 34 x 8,5 mm, Aluminium eloxiert, gebohrt

terminating edge trim for laminate, 34 x 8,5 mm, aluminium anodized, drilled

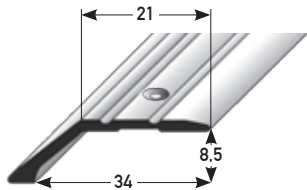

silberfarbig silver	1.0	41580-0	
	2.7	41590-9	
goldfarbig gold	1.0	41600-5	
	2.7	41610-4	
bronzefarbig hell bronze light	1.0	41620-3	
	2.7	41630-2	
bronzefarbig dunkel bronze dark	1.0	41640-1	
	2.7	41650-0	
gold hell gold light	1.0	62245-1	
	2.7	62250-5	

41581-7	
41591-6	
41601-2	
41611-1	
41621-0	
41631-9	
41641-8	
41651-7	
62255-0	
62260-4	

132 Abschlussprofil für Laminat, 34 x 8,5 mm, Aluminium eloxiert, selbstklebend

terminating edge trim for laminate, 34 x 8,5 mm, aluminium anodized, self-adhesive

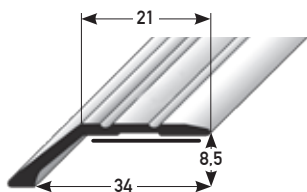

silberfarbig silver	1.0	47922-2	
	2.7	47924-6	
goldfarbig gold	1.0	47930-7	
	2.7	47932-1	
bronzefarbig hell bronze light	1.0	47938-3	
	2.7	47940-6	
bronzefarbig dunkel bronze dark	1.0	47946-8	
	2.7	47948-2	
gold hell gold light	1.0	48100-3	
	2.7	48102-7	

47926-0	
47928-4	
47934-5	
47936-9	
47942-0	
47944-4	
47950-5	
47952-9	
48104-1	
48106-5	

133 Abschlussprofil für Parkett, 47 x 15,5 mm, Aluminium eloxiert, gebohrt

terminating edge trim for wooden floor, 47 x 15,5 mm, aluminium anodized, drilled

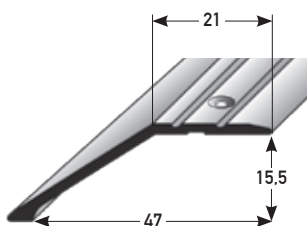

silberfarbig silver	1.0	41660-9	
	2.7	41670-8	
goldfarbig gold	1.0	41680-7	
	2.7	41690-6	
bronzefarbig hell bronze light	1.0	41700-2	
	2.7	41710-1	
bronzefarbig dunkel bronze dark	1.0	41720-0	
	2.7	41730-9	
gold hell gold light	1.0	62275-8	
	2.7	62280-2	

41661-6	
41671-5	
41681-4	
41691-3	
41701-9	
41711-8	
41721-7	
41731-6	
62285-7	
62290-1	

133 Abschlussprofil für Parkett, 47 x 15,5 mm, Aluminium eloxiert, selbstklebend

terminating edge trim for wooden floor, 47 x 15,5 mm, aluminium anodized, self-adhesive

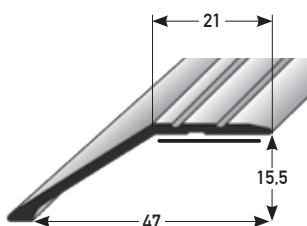

silberfarbig silver	1.0	47956-7	
	2.7	47958-1	
goldfarbig gold	1.0	47964-2	
	2.7	47966-6	
bronzefarbig hell bronze light	1.0	47972-7	
	2.7	47974-1	
bronzefarbig dunkel bronze dark	1.0	47980-2	
	2.7	47982-6	
gold hell gold light	1.0	48110-2	
	2.7	48112-6	

47960-4	
47962-8	
47968-0	
47970-3	
47976-5	
47978-9	
47984-0	
47986-4	
48114-0	
48116-4	

Andere Eloxalfarben siehe
Abschnitt 6. Lieferzeit 14 Tage
other anodized colours see section 6.
delivery time 14 days

SB-Pack à 20 Stück			
self-service-pack à 20 pcs.			
Farbe / colour	L / l (m)	Art. / ref.	€/Stk. / pcs.

137 Sockelprofil, 8 x 18,4 mm, für Wandabschlüsse, Aluminium eloxiert, selbstklebend

plinth profile 8 x 18,4 mm, as wall
finish, aluminium anodized,
self-adhesive

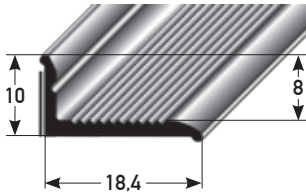

silberfarbig silver	0,9 2,7	41741-5 41751-4	
goldfarbig gold	0,9 2,7	41761-3 41771-2	
bronzefarbig hell bronze light	0,9 2,7	41781-1 41791-0	
edelstahlfarbig/AL-INOX stainless steel coloured	0,9 2,7	41800-9 41810-8	
gold hell gold light	0,9 2,7	62080-8 62085-3	
weiß pulverbeschichtet white powder coated	0,9 2,7	62090-7 62095-2	

Holzdekorfolie / wood dekor	Buche beech	0,9 2,7	41821-4 41831-3	
	Eiche oak	0,9 2,7	41841-2 41851-1	
	Ahorn maple	0,9 2,7	41861-0 41871-9	
	Kirschbaum cherry wood	0,9 2,7	41844-3 41854-2	
	Eiche rustikal rustic oak	0,9 2,7	41864-1 41874-0	

Profipack, VE 10 Stück				SB-Pack inkl. Schr. / Dübel: VE 20 Stk.	
professional packing á 10 pcs.				self-service-pack with screws / dowels: á 20 pcs.	
Farbe / colour	L / l (m)	Art. / ref.	€/Stk. / pcs.	Art. / ref.	€/Stk. / pcs.

506 Abschlussprofil 28 x 3 mm, Aluminium eloxiert, mittig gebohrt

adaption profile 28 x 3 mm,
aluminium anodized, drilled

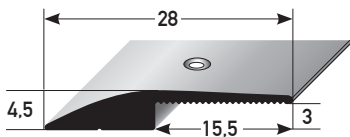

silberfarbig silver	1,0 2,7	71590-0 71592-4		71610-5 71612-9	
goldfarbig gold	1,0 2,7	71594-8 71596-2		71614-3 71616-7	
bronzefarbig hell bronze light	1,0 2,7	71598-6 71600-6		71618-1 71620-4	
bronzef. dunkel bronze dark	1,0 2,7	71602-0 71604-4		71622-8 71624-2	
edelstahlfarbig Feinschliff fine-honed stainless steel coloured	1,0 2,7	71606-8 71608-2		71626-6 71628-0	

506 Abschlussprofil 28 x 3 mm, Aluminium eloxiert, ungebohrt

adaption profile 28 x 3 mm,
aluminium anodized, undrilled

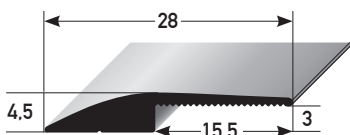

silberfarbig silver	1,0 2,7	71712-6 71714-0		71732-4 71734-8	
goldfarbig gold	1,0 2,7	71716-4 71718-8		71736-2 71738-6	
bronzefarbig hell bronze light	1,0 2,7	71720-1 71722-5		71740-9 71742-3	
bronzef. dunkel bronze dark	1,0 2,7	71724-9 71726-3		71744-7 71746-1	
edelstahlfarbig Feinschliff fine-honed stainless steel coloured	1,0 2,7	71728-7 71730-0		71748-5 71750-8	





5. Einschub- und Anstoßprofile aus Aluminium

5. insert profiles out of aluminium

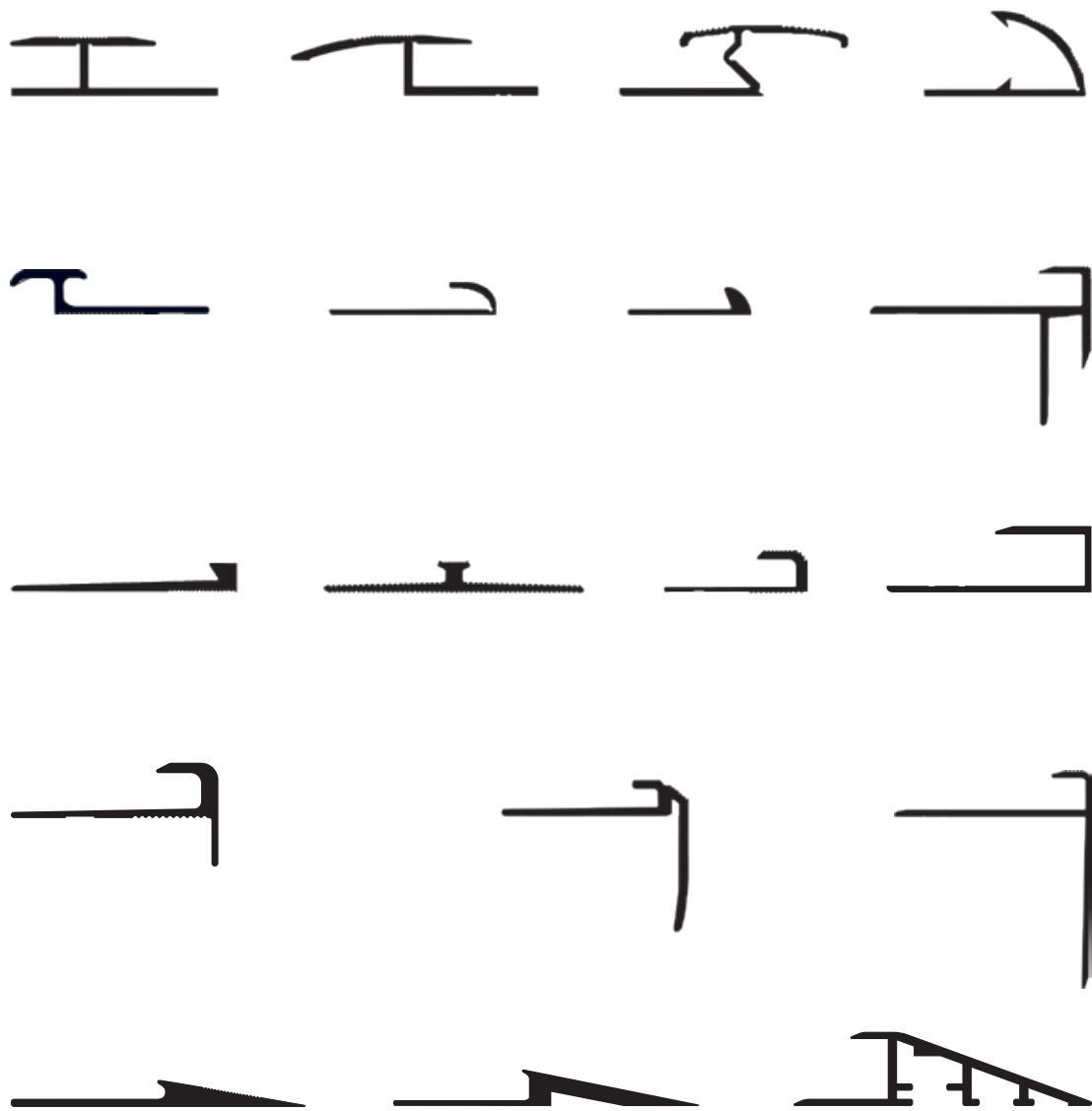

5



Andere Eloxalfarben siehe Abschnitt 6. Lieferzeit 14 Tage
other anodized colours see section 6. delivery time 14 days

Profi-Pack à 10 Stück im Bund			
professional packing à 10 pcs.			
Farbe / colour	L / l (m)	Art. / ref.	€ / Stk. / pcs.

SB-Pack incl. Schr. / Dübel: VE 20 Stk.	
self-service-pack with screws / dowels: à 20 pcs.	
Art. / ref.	€ / Stk. / pcs.

348 Doppelinsertprofil 14 x 3 mm, Aluminium eloxiert, gebohrt

double insert profile 14 x 3 mm, aluminium anodized, drilled

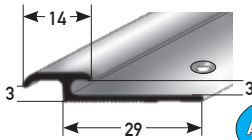

AUSKLINKEN & BIEGEN
notched + bent

silberfarbig silver	1.0	65948-8	
	2.7	65950-1	
goldfarbig gold	1.0	65952-5	
	2.7	65954-9	
bronzefarbig hell bronze light	1.0	65956-3	
	2.7	65958-7	
bronzefarbig dunkel bronze dark	1.0	65960-0	
	2.7	65962-4	

65968-6	
65970-9	
65972-3	
65974-7	
65976-1	
65978-5	
65980-8	
65982-2	

347 Doppelinsertprofil 14 x 5 mm, Aluminium eloxiert, gebohrt

double insert profile 14 x 5 mm, aluminium anodized, drilled

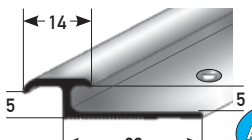

AUSKLINKEN & BIEGEN
notched + bent

silberfarbig silver	1.0	65990-7	
	2.7	65992-1	
goldfarbig gold	1.0	65994-5	
	2.7	65996-9	
bronzefarbig hell bronze light	1.0	65998-3	
	2.7	66000-2	
bronzefarbig dunkel bronze dark	1.0	66002-6	
	2.7	66004-0	

66010-1	
66012-5	
66014-9	
66016-3	
66018-7	
66020-0	
66022-4	
66024-8	

346 Doppelinsertprofil 14 x 7 mm, Aluminium eloxiert, gebohrt

double insert profile 14 x 7 mm, aluminium anodized, drilled

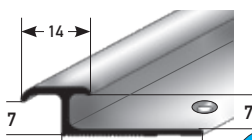

AUSKLINKEN & BIEGEN
notched + bent

silberfarbig silver	1.0	66074-3	
	2.7	66076-7	
goldfarbig gold	1.0	66078-1	
	2.7	66080-4	
bronzefarbig hell bronze light	1.0	66082-8	
	2.7	66084-2	
bronzefarbig dunkel bronze dark	1.0	66086-6	
	2.7	66088-0	

66094-1	
66096-5	
66098-9	
66100-9	
66102-3	
66104-7	
66106-1	
66108-5	

AUSKLINKEN & BIEGEN
notched + bent

Befestigungsschenkel ausklinken attachment flanges notched	
Befestigungsschenkel ausklinken und biegen attachment flanges notched and bent	

Art. / ref.	€ / m
22240-8	
auf Anfrage on request	

130 Laminate-Übergang einteilig 27 x 8,3 x 38 mm, Aluminium eloxiert, gebohrt

laminat edge profile 27 x 8,3 x 38 mm, one-piece, aluminium anodized, drilled

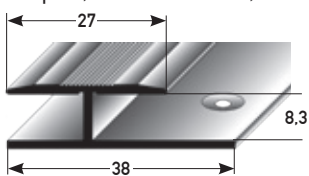

silberfarbig silver	1.0	41500-8	
	2.7	41510-7	
goldfarbig gold	1.0	41520-6	
	2.7	41530-5	
bronzefarbig hell bronze light	1.0	41540-4	
	2.7	41550-3	
bronzefarbig dunkel bronze dark	1.0	41560-2	
	2.7	41570-1	

41501-5	
41511-4	
41521-3	
41531-2	
41541-1	
41551-0	
41561-9	
41571-8	

131 Laminate-Höhenausgleich einteilig 33 x 8,3 x 45 mm, Aluminium eloxiert, gebohrt

laminat height levelling 33 x 8,3 x 45 mm, one-piece, aluminium anodized, drilled

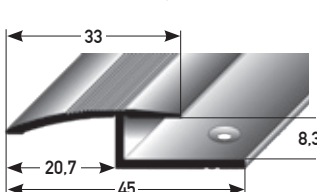

silberfarbig silver	1.0	41420-9	
	2.7	41430-8	
goldfarbig gold	1.0	41440-7	
	2.7	41450-6	
bronzefarbig hell bronze light	1.0	41460-5	
	2.7	41470-4	
bronzefarbig dunkel bronze dark	1.0	41480-3	
	2.7	41490-2	

41421-6	
41431-5	
41441-4	
41451-3	
41461-2	
41471-1	
41481-0	
41491-9	



Andere Eloxalfarben siehe Abschnitt 6, Lieferzeit 14 Tage
 other anodized colours see section 6, delivery time 14 days

Profi-Pack à 10 Stück im Bund			
professional packing à 10 pcs.			
Farbe/colour	L/l (m)	Art./ref.	€/Stk./pcs.

SB-Pack incl. Schr./Dübel: VE 20 Stk.	
self-service-pack with screws/dowels; à 20 pcs.	
Art./ref.	€/Stk./pcs.

20 Doppelklemmprofil, Aluminium eloxiert, gebohrt

double jam profile, aluminium anodized, drilled

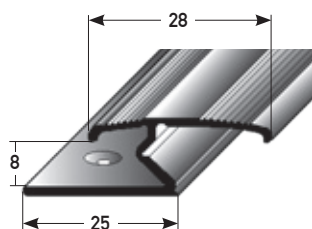

silberfarbig silver	0,9	25090-6	
	1,0	25100-2	
	2,7	25110-1	
goldfarbig gold	0,9	25190-3	
	1,0	25200-9	
	2,7	25210-8	
bronzefarbig hell bronze light	0,9	25290-0	
	1,0	25300-6	
	2,7	25310-5	
bronzefarbig dunkel bronze dark	0,9	25390-7	
	1,0	25400-3	
	2,7	25410-2	

25091-3	
25101-9	
25111-8	
25191-0	
25201-6	
25211-5	
25291-7	
25301-3	
25311-2	
25391-4	
25401-0	
25411-9	

auf Anfrage auch selbstklebend erhältlich
 self-adhesive version available on request

19 Einfachklemmprofil, Aluminium eloxiert, gebohrt

single jam profile, aluminium anodized, drilled

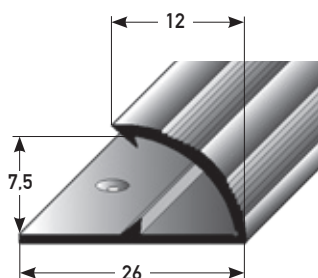

silberfarbig silver	0,9	24090-7	
	1,0	24100-3	
	2,7	24110-2	
goldfarbig gold	0,9	24190-4	
	1,0	24200-0	
	2,7	24210-9	
bronzefarbig hell bronze light	0,9	24290-1	
	1,0	24300-7	
	2,7	24310-6	
bronzefarbig dunkel bronze dark	0,9	24390-8	
	1,0	24400-4	
	2,7	24410-3	

24091-4	
24101-0	
24111-9	
24191-1	
24201-7	
24211-6	
24291-8	
24301-4	
24311-3	
24391-5	
24401-1	
24411-0	

auf Anfrage auch selbstklebend erhältlich
 self-adhesive version available on request

23 Miniklemmprofil, Aluminium eloxiert, ungebohrt

mini jam profile, aluminium anodized, drilled

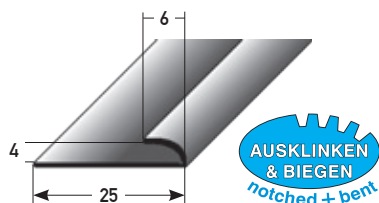

silberfarbig silver	1,0	36150-3	
	2,7	36110-7	
goldfarbig gold	1,0	36160-2	
	2,7	36120-6	
bronzefarbig hell bronze light	1,0	36170-1	
	2,7	36130-5	
bronzefarbig dunkel bronze dark	1,0	36180-0	
	2,7	36140-4	

36151-0	
36111-4	
36161-9	
36121-3	
36171-8	
36131-2	
36181-7	
36141-1	

auf Anfrage auch selbstklebend erhältlich
 self-adhesive version available on request



Befestigungsschenkel ausklinken attachment flanges notched
Befestigungsschenkel ausklinken und biegen attachment flanges notched and bent

Art./ref.	€/m
22240-8	
auf Anfrage on request	



Andere Eloxalfarben siehe Abschnitt 6. Lieferzeit 14 Tage
other anodized colours see section 6. delivery time 14 days

Profi-Pack à 10 Stück im Bund			
professional packing à 10 pcs.			
Farbe / colour	L / l (m)	Art. / ref.	€/Stk. / pcs.

SB-Pack incl. Schr. / Dübel: VE 20 Stk.	
self-service-pack with screws / dowels: à 20 pcs.	
Art. / ref.	€/Stk. / pcs.

269 Einfasssschiene 2 mm, Aluminium eloxiert, gebohrt

insert profile 2 mm.
aluminium anodized, drilled

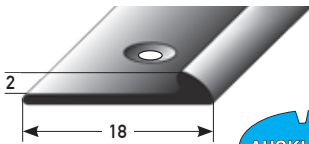

AUSKLINKEN & BIEGEN
notched + bent

silberfarbig silver	2,7	46652-9	
goldfarbig gold		46654-3	
bronzefarbig hell bronze light		46656-7	
bronzefarbig dunkel bronze dark		46658-1	

46664-2	
46666-6	
46668-0	
46670-3	

387 Einfasssschiene 2,5 mm, Aluminium eloxiert, gebohrt

insert profile 2.5 mm.
aluminium anodized, drilled

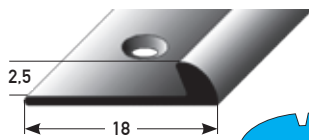

AUSKLINKEN & BIEGEN
notched + bent

silberfarbig silver	2,7	66748-3	
goldfarbig gold		66750-6	
bronzefarbig hell bronze light		66752-0	
bronzefarbig dunkel bronze dark		66754-4	

66764-3	
66766-7	
66768-1	
66770-4	

22 Einfasssschiene 3 mm, Aluminium eloxiert, gebohrt

insert profile 3 mm.
aluminium anodized, drilled

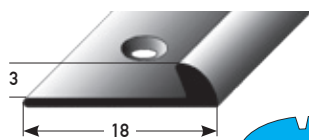

AUSKLINKEN & BIEGEN
notched + bent

silberfarbig silver	2,7	46674-1	
goldfarbig gold		46676-5	
bronzefarbig hell bronze light		46678-9	
bronzefarbig dunkel bronze dark		46680-2	

46684-0	
46686-4	
46688-8	
46690-1	

268 Einfasssschiene 5 mm, Aluminium eloxiert, gebohrt

insert profile 5 mm.
aluminium anodized, drilled

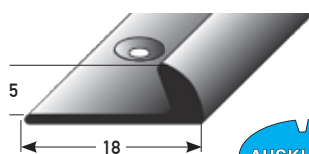

AUSKLINKEN & BIEGEN
notched + bent

silberfarbig silver	2,7	46696-3	
goldfarbig gold		46698-7	
bronzefarbig hell bronze light		46700-7	
bronzefarbig dunkel bronze dark		46702-1	

46708-3	
46710-6	
46712-0	
46714-4	

AUSKLINKEN & BIEGEN
notched + bent

Befestigungsschenkel ausklinken
attachment flanges notched

Art. / ref.	€/m
22240-8	

Befestigungsschenkel ausklinken und biegen
attachment flanges notched and bent

auf Anfrage
on request



Andere Eloxalfarben siehe Abschnitt 6, Lieferzeit 14 Tage
other anodized colours see section 6, delivery time 14 days

Profi-Pack à 10 Stück im Bund			
professional packing à 10 pcs.			
Farbe/colour	L/l (m)	Art./ref.	€/Stk./pcs.

SB-Pack incl. Schr./Dübel: VE 20 Stk.	
self-service-pack with screws/dowels; à 20 pcs.	
Art./ref.	€/Stk./pcs.

27 Anstoßprofil 3 mm, Aluminium eloxiert, gebohrt

edge profile 3 mm, aluminium anodized, drilled

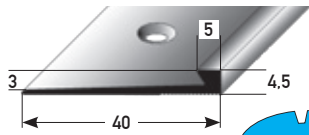

silberfarbig silver	2.7	47904-8	
goldfarbig gold		47908-6	
bronzefarbig hell bronze light		47912-3	
bronzefarbig dunkel bronze dark		47916-1	

47906-2	
47910-9	
47914-7	
47918-5	

29 Anstoßprofil 5/3, doppelseitig, Aluminium eloxiert, gebohrt

edge profile 5/3, double, aluminium anodized, drilled

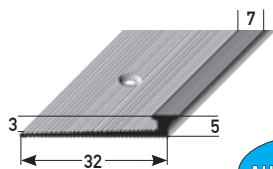

silberfarbig silver	2.7	35870-1	
goldfarbig gold		35880-0	
bronzefarbig hell bronze light		35890-9	
bronzefarbig dunkel bronze dark		35900-5	

35871-8	
35881-7	
35891-6	
35901-2	



Befestigungsschenkel ausklinken attachment flanges notched	Art./ref. 22240-8	€/m
Befestigungsschenkel ausklinken und biegen attachment flanges notched and bent	auf Anfrage on request	

28 Anstoßprofil 3/3, doppelseitig, Aluminium eloxiert, gebohrt

edge profile 3/3, double, aluminium anodized, drilled

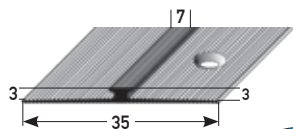

silberfarbig silver	2.7	35950-0	
goldfarbig gold		35960-9	
bronzefarbig hell bronze light		35970-8	
bronzefarbig dunkel bronze dark		35980-7	

35951-7	
35961-6	
35971-5	
35981-4	

30 Anstoßprofil 5/5, doppelseitig, Aluminium eloxiert, gebohrt

edge profile 5/5, double, aluminium anodized, drilled

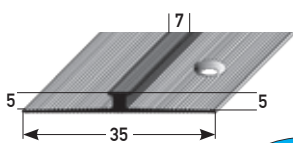

silberfarbig silver	2.7	36030-8	
goldfarbig gold		36040-7	
bronzefarbig hell bronze light		36050-6	
bronzefarbig dunkel bronze dark		36060-5	

36031-5	
36041-4	
36051-3	
36061-2	



2 x Befestigungsschenkel ausklinken 2 x attachment flanges notched	Art./ref. 22260-6	€/m
Befestigungsschenkel ausklinken und biegen attachment flanges notched and bent	auf Anfrage on request	



Andere Eloxalfarben siehe Abschnitt 6. Lieferzeit 14 Tage
other anodized colours see section 6. delivery time 14 days

Profi-Pack à 10 Stück im Bund			
professional packing à 10 pcs.			
Farbe / colour	L / l (m)	Art. / ref.	€/Stk. / pcs.

SB-Pack incl. Schr. / Dübel: VE 20 Stk.	
self-service-pack with screws / dowels: à 20 pcs.	
Art. / ref.	€/Stk. / pcs.

282 Rampenanstoß 2 mm, Aluminium eloxiert, gebohrt

ramp profile 2 mm.
aluminium anodized, drilled

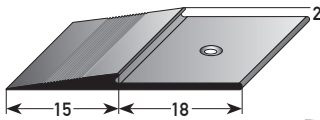

silberfarbig silver	1.0	35724-7	
	2.7	35726-1	
goldfarbig gold	1.0	35728-5	
	2.7	35730-8	
bronzefarbig hell bronze light	1.0	35732-2	
	2.7	35734-6	
bronzefarbig dunkel bronze dark	1.0	35736-0	
	2.7	35738-4	
edelstahlfarb. /AL-INOX stainless steel coloured	1.0	35710-0	
	2.7	35712-4	

35740-7	
35742-1	
35744-5	
35746-9	
35748-3	
35750-6	
35752-0	
35754-4	
35714-8	
35716-2	

283 Rampenanstoß 3 mm, Aluminium eloxiert, gebohrt

ramp profile 3 mm.
aluminium anodized, drilled

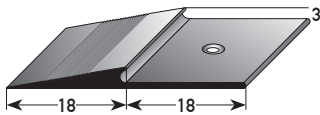

silberfarbig silver	1.0	35800-8	
	2.7	35802-2	
goldfarbig gold	1.0	35804-6	
	2.7	35806-0	
bronzefarbig hell bronze light	1.0	35808-4	
	2.7	35810-7	
bronzefarbig dunkel bronze dark	1.0	35812-1	
	2.7	35814-5	
edelstahlfarb. /AL-INOX stainless steel coloured	1.0	35720-9	
	2.7	35722-3	

35816-9	
35818-3	
35820-6	
35822-0	
35824-4	
35826-8	
35828-2	
35830-5	
35756-8	
35758-2	

284 Rampenanstoß 5 mm, Aluminium eloxiert, gebohrt

ramp profile 5 mm.
aluminium anodized, drilled

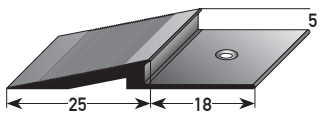

silberfarbig silver	1.0	35832-9	
	2.7	35834-3	
goldfarbig gold	1.0	35836-7	
	2.7	35838-1	
bronzefarbig hell bronze light	1.0	35840-4	
	2.7	35842-8	
bronzefarbig dunkel bronze dark	1.0	35844-2	
	2.7	35846-6	
edelstahlfarb. /AL-INOX stainless steel coloured	1.0	35762-9	
	2.7	35764-3	

35848-0	
35850-3	
35852-7	
35854-1	
35856-5	
35858-9	
35860-2	
35862-6	
35766-7	
35768-1	

480 Rampenanstoß 8 mm, Aluminium eloxiert, gebohrt

ramp profile 8 mm.
aluminium anodized, drilled

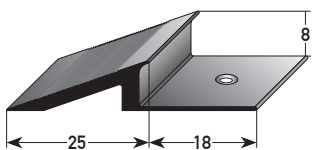

silberfarbig silver	1.0	70916-9	
	2.7	70918-3	
goldfarbig gold	1.0	70920-6	
	2.7	70922-0	
bronzefarbig hell bronze light	1.0	70924-4	
	2.7	70926-8	
bronzefarbig dunkel bronze dark	1.0	70928-2	
	2.7	70930-5	
edelstahlfarb. /AL-INOX stainless steel coloured	1.0	70932-9	
	2.7	70934-3	

70936-7	
70938-1	
70940-4	
70942-8	
70944-2	
70946-6	
70948-0	
70950-3	
70952-7	
70954-1	



Befestigungsschenkel ausklinken attachment flanges notched
Befestigungsschenkel ausklinken und biegen attachment flanges notched and bent

Art. / ref.	€/m
22240-8	
auf Anfrage on request	



Andere Eloxalfarben siehe
Abschnitt 6, Lieferzeit 14 Tage
other anodized colours see section 6,
delivery time 14 days

Profi-Pack à 10 Stück im Bund			
professional packing à 10 pcs.			
Farbe/colour	L/l (m)	Art./ref.	€/Stk./pcs.

525 Rampeneinschub 10 mm, Aluminium eloxiert, ungebohrt

ramp insertion profile 10 mm, aluminium
anodized, undrilled

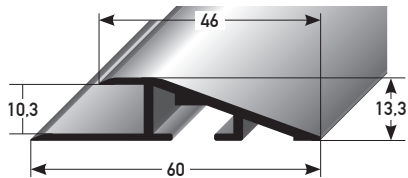

silberfarbig silver	2.7	72112-3	
------------------------	-----	---------	--

526 Rampeneinschub 15 mm, Aluminium eloxiert, ungebohrt

ramp insertion profile 15 mm,
aluminium anodized, undrilled

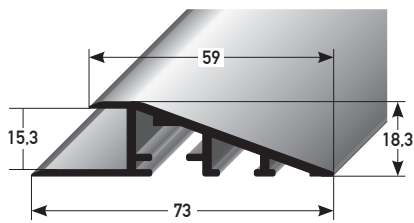

silberfarbig silver	2.7	72118-5	
------------------------	-----	---------	--

527 Rampeneinschub 22 mm, Aluminium eloxiert, ungebohrt

ramp insertion profile 22 mm,
aluminium anodized, undrilled

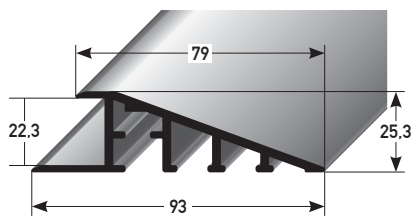

silberfarbig silver	2.7	72124-6	
------------------------	-----	---------	--

528 Längsverbinder für Rampeneinschubprofile, Stahl verzinkt

longitudinal connector for ramp insertion
profiles, galvanized steel



72130-7	
---------	--

529 Eckverbinder für 90°-Ecke, für Rampeneinschubprofile, Stahl verzinkt

corner connector for 90° corner,
for ramp insertion profiles, galvanized steel

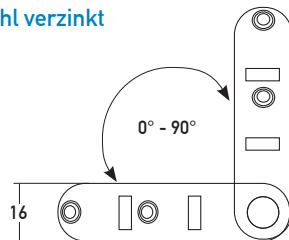

72136-9	
---------	--

536 Eckverbinder flexible Ecke, für Rampeneinschubprofile, Stahl verzinkt

corner connector for flexible corner,
for ramp insertion profiles, galvanized steel

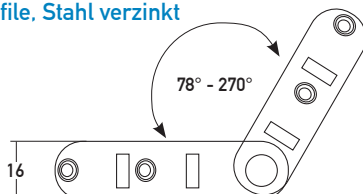

72131-4	
---------	--



Andere Eloxalfarben siehe Abschnitt 6. Lieferzeit 14 Tage
other anodized colours see section 6. delivery time 14 days

Profi-Pack à 10 Stück im Bund			
professional packing à 10 pcs.			
Farbe / colour	L / l (m)	Art. / ref.	€/Stk. / pcs.

SB-Pack incl. Schr. / Dübel: VE 20 Stk.	
self-service-pack with screws / dowels: à 20 pcs.	
Art. / ref.	€/Stk. / pcs.

258 Einschubprofil 3 mm, Aluminium eloxiert, gebohrt

insert profile 3 mm, grooved aluminium, anodized, drilled

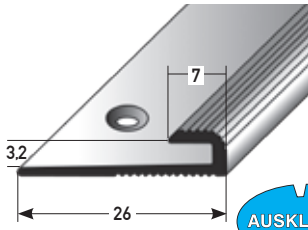

AUSKLINKEN & BIEGEN
notched + bent

silberfarbig silver	0.9	46718-2	
	1.0	46720-5	
	2.7	46722-9	
goldfarbig gold	0.9	46732-8	
	1.0	46734-2	
	2.7	46736-6	
bronzefarbig hell bronze light	0.9	46746-5	
	1.0	46748-9	
	2.7	46750-2	
bronzefarbig dunkel bronze dark	0.9	46760-1	
	1.0	46762-5	
	2.7	46764-9	

46724-3	
46726-7	
46728-1	
46738-0	
46740-3	
46742-7	
46752-6	
46754-0	
46756-4	
46766-3	
46768-7	
46770-0	

530 Einschubprofil 3 mm, glatt, Aluminium eloxiert, gebohrt

insert profile 3 mm, smooth aluminium, anodized, drilled

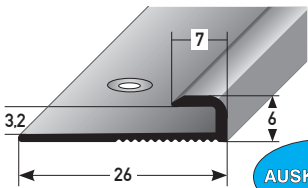

NEU!

AUSKLINKEN & BIEGEN
notched + bent

silberfarbig silver	0.9	72142-0	
	2.7	72144-4	
edelstahlfarbig stainless steel, coloured	0.9	72150-5	
	2.7	72152-9	
schwarz black	0.9	72578-7	
	2.7	72580-0	

72146-8	
72148-2	
72154-3	
72156-7	
72582-4	
72584-8	

18 Einschubprofil 5 mm, Aluminium eloxiert, gebohrt

insert profile 5 mm, grooved aluminium anodized, drilled

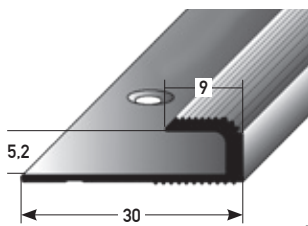

AUSKLINKEN & BIEGEN
notched + bent

silberfarbig silver	0.9	26090-5	
	1.0	26100-1	
	2.7	26130-8	
goldfarbig gold	0.9	26190-2	
	1.0	26200-8	
	2.7	26230-5	
bronzefarbig hell bronze light	0.9	26290-9	
	1.0	26300-5	
	2.7	26330-2	
bronzefarbig dunkel bronze dark	0.9	26390-6	
	1.0	26400-2	
	2.7	26430-9	

26091-2	
26101-8	
26131-5	
26191-9	
26201-5	
26231-2	
26291-6	
26301-2	
26331-9	
26391-3	
26401-9	
26431-6	

531 Einschubprofil 5 mm, glatt, Aluminium eloxiert, gebohrt

insert profile 5 mm, smooth aluminium, anodized, drilled

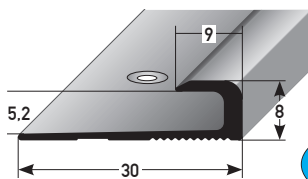

NEU!

AUSKLINKEN & BIEGEN
notched + bent

silberfarbig silver	0.9	72160-4	
	2.7	72162-8	
edelstahlfarbig stainless steel, coloured	0.9	72168-0	
	2.7	72170-3	
schwarz black	0.9	72586-2	
	2.7	72588-6	

72164-2	
72166-6	
72172-7	
72174-1	
72590-9	
72592-3	

AUSKLINKEN & BIEGEN
notched + bent

Befestigungsschenkel ausklinken attachment flanges notched	Art. / ref.	€/m
Befestigungsschenkel ausklinken und biegen attachment flanges notched and bent	22240-8	
auf Anfrage on request		



5. EINSCHUB- UND ANSTOßPROFILE / 5. INSERT PROFILES

Andere Eloxalfarben siehe Abschnitt 6, Lieferzeit 14 Tage
other anodized colours see section 6, delivery time 14 days

Profi-Pack à 10 Stück im Bund			
professional packing à 10 pcs.			
Farbe / colour	L / l (m)	Art. / ref.	€ / Stk. / pcs.

SB-Pack incl. Schr. / Dübel: VE 20 Stk.	
self-service-pack with screws / dowels: à 20 pcs.	
Art. / ref.	€ / Stk. / pcs.

24 Einschubprofil 6 mm, Aluminium eloxiert, gebohrt

insert profile 6 mm, aluminium anodized, drilled

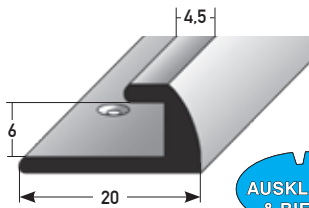

AUSKLINKEN & BIEGEN
notched + bent

silberfarbig silver	2.7	47886-7	
goldfarbig gold		47890-4	
bronzefarbig hell bronze light		47894-2	
bronzefarbig dunkel bronze dark		47898-0	

47888-1	
47892-8	
47896-6	
47900-0	

auf Anfrage auch selbstklebend erhältlich
self-adhesive version available on request

446 Einschubprofil für Laminat 7,5 mm, Aluminium eloxiert, gebohrt

insert profile for laminate 7.5 mm, aluminium anodized, drilled

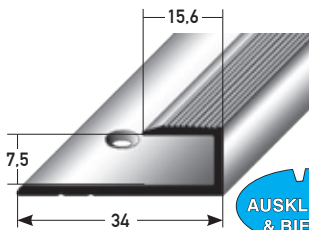

AUSKLINKEN & BIEGEN
notched + bent

silberfarbig silver	1.0	48120-1	
	2.7	48122-5	
goldfarbig gold	1.0	48128-7	
	2.7	48130-0	
bronzefarbig hell bronze light	1.0	48144-7	
	2.7	48146-1	
bronzefarbig dunkel bronze dark	1.0	48152-2	
	2.7	48154-6	

48124-9	
48126-3	
48132-4	
48134-8	
48148-5	
48150-8	
48156-0	
48158-4	

108 Einschubprofil für Laminat 8,5 mm, Aluminium eloxiert, gebohrt

insert profile for laminate 8.5 mm, aluminium anodized, drilled

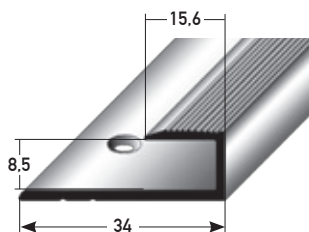

AUSKLINKEN & BIEGEN
notched + bent

silberfarbig silver	1.0	29160-2	
	2.7	29165-7	
goldfarbig gold	1.0	29170-1	
	2.7	29175-6	
bronzefarbig hell bronze light	1.0	29180-0	
	2.7	29185-5	
bronzefarbig dunkel bronze dark	1.0	29190-9	
	2.7	29195-4	
gold hell gold light	1.0	62135-5	
	2.7	62140-9	

29166-4	
29167-1	
29176-3	
29177-0	
29186-2	
29187-9	
29196-1	
29197-8	
62145-4	
62155-3	

Holzdekorfolie / wood dekor	Buche beech	1.0	40580-1	
		2.7	40600-6	
	Eiche oak	1.0	40610-5	
		2.7	40630-3	
	Ahorn maple	1.0	40640-2	
		2.7	40660-0	
	Kirschbaum cherry wood	1.0	43154-1	
		2.7	43158-9	
	Eiche rustikal rustic oak	1.0	43162-6	
		2.7	43166-4	

40581-8	
40601-3	
40611-2	
40631-0	
40641-9	
40661-7	
43156-5	
43160-2	
43164-0	
43168-8	

AUSKLINKEN & BIEGEN
notched + bent

Befestigungsschenkel ausklinken attachment flanges notched
Befestigungsschenkel ausklinken und biegen attachment flanges notched and bent

Art. / ref.	€/m
22240-8	
auf Anfrage on request	



Andere Eloxalfarben siehe Abschnitt 6. Lieferzeit 14 Tage
other anodized colours see section 6. delivery time 14 days

Profi-Pack à 10 Stück im Bund			
professional packing à 10 pcs.			
Farbe/colour	L/l (m)	Art./ref.	€/Stk./pcs.

SB-Pack incl. Schr./ Dübel, VE 20 Stk.	
self-service-pack with screws / dowels; à 20 pcs.	
Art./ref.	€/Stk./pcs.

532 Einschubprofil 8,5 mm, glatt, Aluminium eloxiert, gebohrt

insert profile 8.5 mm, smooth aluminium anodized, drilled

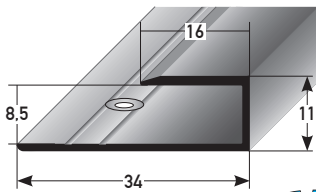

silberfarbig silver	0.9	72178-9	
	2.7	72180-2	
edelstahlfarbig stainless steel coloured	0.9	72186-4	
	2.7	72188-8	
schwarz black	0.9	72570-1	
	2.7	72572-5	

72182-6	
72184-0	
72190-1	
72192-5	
72574-9	
72576-3	

109 Einschubprofil für Parkett 10 mm, Aluminium eloxiert, gebohrt

insert profile for wooden floors 10 mm, aluminium anodized, drilled

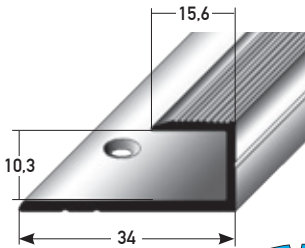

silberfarbig silver	1.0	29500-6	
	2.7	29505-1	
goldfarbig gold	1.0	29510-5	
	2.7	29515-0	
bronzefarbig hell bronze light	1.0	29520-4	
	2.7	29525-9	
bronzefarbig dunkel bronze dark	1.0	29530-3	
	2.7	29535-8	

29506-8	
29507-5	
29516-7	
29517-4	
29526-6	
29527-3	
29536-5	
29537-2	

110 Einschubprofil für Parkett 13 mm, Aluminium eloxiert, gebohrt

insert profile for wooden floors 13 mm, aluminium anodized, drilled

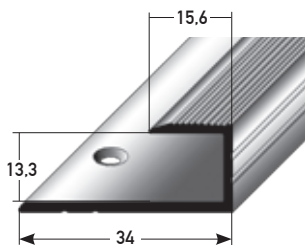

silberfarbig silver	1.0	29540-2	
	2.7	29545-7	
goldfarbig gold	1.0	29550-1	
	2.7	29555-6	
bronzefarbig hell bronze light	1.0	29560-0	
	2.7	29565-5	
bronzefarbig dunkel bronze dark	1.0	29570-9	
	2.7	29575-4	

29546-4	
29547-1	
29556-3	
29557-0	
29566-2	
29567-9	
29576-1	
29577-8	



Befestigungsschenkel ausklinken attachment flanges notched
Befestigungsschenkel ausklinken und biegen attachment flanges notched and bent

Art./ref.	€/m
22240-8	
auf Anfrage on request	



5. EINSCHUB- UND ANSTOßPROFILE / 5. INSERT PROFILES

Andere Eloxalfarben siehe Abschnitt 6, Lieferzeit 14 Tage
other anodized colours see section 6, delivery time 14 days

Profi-Pack à 10 Stück im Bund

professional packing à 10 pcs.

Farbe / colour	L/l (m)	Art./ref.	€/Stk./pcs.
----------------	---------	-----------	-------------

SB-Pack incl. Schr./Dübel;
VE 20 Stk.

self-service-pack with screws/dowels; à 20 pcs.

Art./ref.	€/Stk./pcs.
-----------	-------------

111 Einschubprofil 15 mm, Aluminium eloxiert, gebohrt

insert profile for wooden floors 15 mm, aluminium anodized, drilled

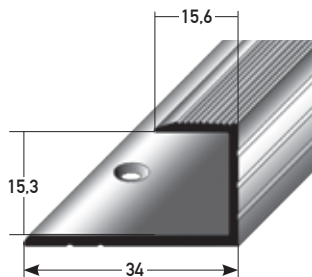

AUSKLINKEN & BIEGEN
notched + bent

silberfarbig silver	1.0	29580-8	
	2.7	29585-3	
goldfarbig gold	1.0	29590-7	
	2.7	29595-2	
bronzefarbig hell bronze light	1.0	29600-3	
	2.7	29605-8	
bronzefarbig dunkel bronze dark	1.0	29610-2	
	2.7	29615-7	
gold hell gold light	1.0	62100-3	
	2.7	62105-8	

29586-0	
29587-7	
29596-9	
29597-6	
29606-5	
29607-2	
29616-4	
29617-1	
62110-2	
62120-1	

Holzdekorfolie / wood dekor			
	Buche beech	1.0	40670-9
	2.7	40690-7	40691-4
Eiche oak	1.0	40700-3	40701-0
	2.7	40720-1	40721-8
Ahorn maple	1.0	40730-0	40731-7
	2.7	40750-8	40751-5
Kirschbaum cherry wood	1.0	43172-5	43174-9
	2.7	43176-3	43178-7
Eiche rustikal rustic oak	1.0	43180-0	43182-4
	2.7	43184-8	43186-2

533 Einschubprofil 15,5 mm, glatt, Aluminium eloxiert, gebohrt

insert profile 15.5 mm, smooth aluminium, anodized, drilled

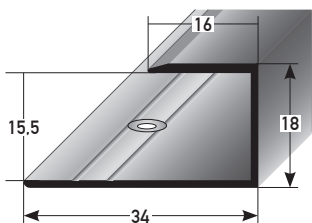

NEU!

AUSKLINKEN & BIEGEN
notched + bent

silberfarbig silver	0.9	72196-3	
	2.7	72198-7	
edelstahlfarbig stainless steel coloured	0.9	72204-5	
	2.7	72206-9	
schwarz black	0.9	72562-6	
	2.7	72564-0	

72200-7	
72202-1	
72208-3	
72210-6	
72566-4	
72568-8	

AUSKLINKEN & BIEGEN
notched + bent

Befestigungsschenkel ausklinken
attachment flanges notched

Art./ref.	€/m
22240-8	

Befestigungsschenkel ausklinken und biegen
attachment flanges notched and bent

auf Anfrage
on request



Andere Eloxalfarben siehe Abschnitt 6. Lieferzeit 14 Tage
other anodized colours see section 6. delivery time 14 days

Profi-Pack à 10 Stück im Bund			
professional packing à 10 pcs.			
Farbe / colour	L / l (m)	Art. / ref.	€ / Stk. / pcs.

SB-Pack incl. Schr. / Dübel: VE 20 Stk.	
self-service-pack with screws / dowels: à 20 pcs.	
Art. / ref.	€ / Stk. / pcs.

21 **Einschubprofil 3 mm mit 7 mm Nase, Aluminium eloxiert, gebohrt**

insert profile 3 mm with 7 mm nose, aluminium anodized, drilled

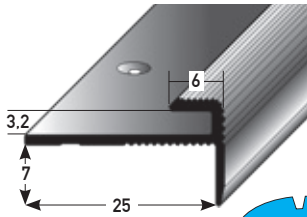

AUSKLINKEN & BIEGEN
notched + bent

silberfarbig silver	0.9	32070-8	
	1.0	32075-3	
	2.7	32080-7	
goldfarbig gold	0.9	32085-2	
	1.0	32090-6	
	2.7	32095-1	
bronzefarbig hell bronze light	0.9	32100-2	
	1.0	32105-7	
	2.7	32110-1	
bronzefarbig dunkel bronze dark	0.9	32115-6	
	1.0	32120-0	
	2.7	32125-5	

32071-5	
32076-0	
32081-4	
32086-9	
32091-3	
32096-8	
32101-9	
32106-4	
32111-8	
32116-3	
32121-7	
32126-2	

534 **Einschubprofil 3 mm mit 7 mm Nase, glatt, Aluminium eloxiert, gebohrt**

insert profile 3 mm with 7 mm nose, smooth, aluminium anodized, drilled

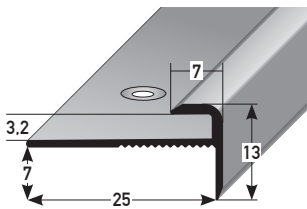

NEU!

AUSKLINKEN & BIEGEN
notched + bent

silberfarbig silver	0.9	72214-4	
	2.7	72216-8	
edelstahlfarbig stainless steel coloured	0.9	72222-9	
	2.7	72224-3	
schwarz black	0.9	72554-1	
	2.7	72556-5	

72218-2	
72220-5	
72226-7	
72228-1	
72558-9	
72560-2	

478 **Einschubprofil 3 mm mit 24 mm Nase, Aluminium eloxiert gebohrt**

insert profile 3 mm with 24 mm nose, aluminium anodized, drilled

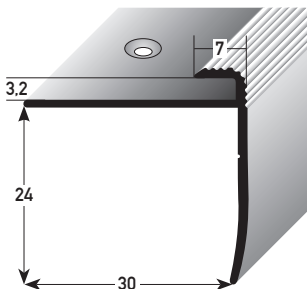

AUSKLINKEN & BIEGEN
notched + bent

silberfarbig silver	1.0	70862-9	
	2.7	70864-3	
goldfarbig gold	1.0	70870-4	
	2.7	70872-8	
bronzefarbig hell bronze light	1.0	70878-0	
	2.7	70880-3	
bronzefarbig dunkel bronze dark	1.0	70886-5	
	2.7	70888-9	

70866-7	
70868-1	
70874-2	
70876-6	
70882-7	
70884-1	
70890-2	
70892-6	

AUSKLINKEN & BIEGEN
notched + bent

Befestigungsschenkel ausklinken attachment flanges notched
Befestigungsschenkel ausklinken und biegen attachment flanges notched and bent

Art. / ref.	€/m
22240-8	
auf Anfrage on request	



Andere Eloxalfarben siehe Abschnitt 6, Lieferzeit 14 Tage
other anodized colours see section 6, delivery time 14 days

Profi-Pack à 10 Stück im Bund			
professional packing à 10 pcs.			
Farbe/colour	L/l (m)	Art./ref.	€/Stk./pcs.

SB-Pack incl. Schr./Dübel: VE 20 Stk.	
self-service-pack with screws/dowels; à 20 pcs.	
Art./ref.	€/Stk./pcs.

501 Einschubprofil 3 mm mit 44 mm Nase, Aluminium eloxiert, gebohrt

insert profile 3 mm with 44 mm nose, aluminium anodized, drilled

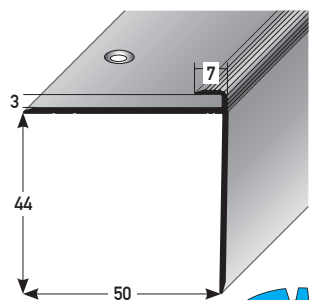

AUSKLINKEN & BIEGEN
notched + bent

silberfarbig silver	1.0	71462-0	
	2.7	71464-4	
goldfarbig gold	1.0	71466-8	
	2.7	71468-2	
bronzefarbig hell bronze light	1.0	71470-5	
	2.7	71472-9	
bronzefarbig dunkel bronze dark	1.0	71474-3	
	2.7	71476-7	

71478-1	
71480-4	
71482-8	
71484-2	
71486-6	
71488-0	
71490-3	
71492-7	

17 Einschubprofil 5 mm mit 7 mm Nase, Aluminium eloxiert, gebohrt

insert profile 5 mm with 7 mm nose, aluminium anodized, drilled

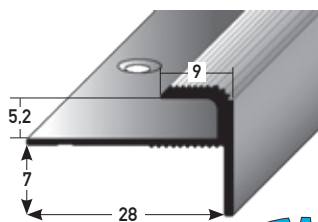

AUSKLINKEN & BIEGEN
notched + bent

silberfarbig silver	0.9	27090-4	
	1.0	27100-0	
	2.7	27130-7	
goldfarbig gold	0.9	27190-1	
	1.0	27200-7	
	2.7	27230-4	
bronzefarbig hell bronze light	0.9	27290-8	
	1.0	27300-4	
	2.7	27330-1	
bronzefarbig dunkel bronze dark	0.9	27390-5	
	1.0	27400-1	
	2.7	27430-8	

27091-1	
27101-7	
27131-4	
27191-8	
27201-4	
27231-1	
27291-5	
27301-1	
27331-8	
27391-2	
27401-8	
27431-5	

535 Einschubprofil 5 mm mit 7 mm Nase, glatt, Aluminium eloxiert, gebohrt

insert profile 5 mm with 7 mm nose, smooth, aluminium anodized, drilled

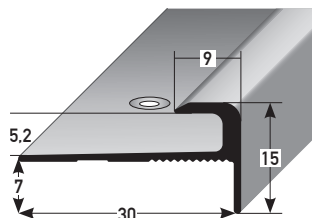

AUSKLINKEN & BIEGEN
notched + bent

silberfarbig silver	0.9	72232-8	
	2.7	72234-2	
edelstahlfarbig stainless steel coloured	0.9	72240-3	
	2.7	72242-7	
schwarz black	0.9	72546-6	
	2.7	72548-0	

72236-6	
72238-0	
72244-1	
72246-5	
72550-3	
72552-7	

AUSKLINKEN & BIEGEN
notched + bent

Befestigungsschenkel ausklinken attachment flanges notched
Befestigungsschenkel ausklinken und biegen attachment flanges notched and bent

Art./ref.	€/m
22240-8	
auf Anfrage on request	



Andere Eloxalfarben siehe Abschnitt 6. Lieferzeit 14 Tage
other anodized colours see section 6. delivery time 14 days

Profi-Pack à 10 Stück im Bund			
professional packing à 10 pcs.			
Farbe / colour	L / l (m)	Art. / ref.	€ / Stk. / pcs.

SB-Pack incl. Schr. / Dübel: VE 20 Stk.	
self-service-pack with screws / dowels: à 20 pcs.	
Art. / ref.	€ / Stk. / pcs.

93 **Einschubprofil 5 mm mit 24 mm Nase, Aluminium eloxiert, gebohrt**

insert profile 5 mm with 24 mm nose, aluminium anodized, drilled

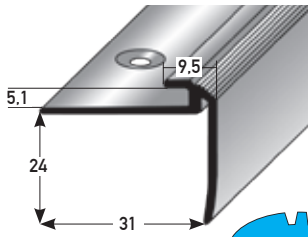

AUSKLINKEN & BIEGEN
notched + bent

silberfarbig silver	0.9	32005-0	
	1.0	32010-4	
	2.7	32015-9	
goldfarbig gold	0.9	32020-3	
	1.0	32025-8	
	2.7	32030-2	
bronzefarbig hell bronze light	0.9	32035-7	
	1.0	32040-1	
	2.7	32045-6	
bronzefarbig dunkel bronze dark	0.9	32050-0	
	1.0	32055-5	
	2.7	32060-9	

32006-7	
32011-1	
32016-6	
32021-0	
32026-5	
32031-9	
32036-4	
32041-8	
32046-3	
32051-7	
32056-2	
32061-6	

502 **Einschubprofil 5 mm mit 44 mm Nase, Aluminium eloxiert, gebohrt**

insert profile 5 mm with 44 mm nose, alu anodized, drilled

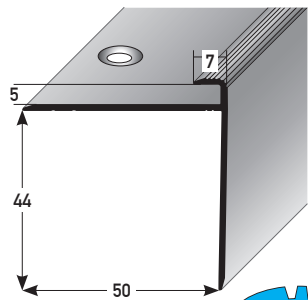

AUSKLINKEN & BIEGEN
notched + bent

silberfarbig silver	1.0	71498-9	
	2.7	71500-9	
goldfarbig gold	1.0	71502-3	
	2.7	71504-7	
bronzefarbig hell bronze light	1.0	71506-1	
	2.7	71508-5	
bronzefarbig dunkel bronze dark	1.0	71510-8	
	2.7	71512-2	

71514-6	
71516-0	
71518-4	
71520-7	
71522-1	
71524-5	
71526-9	
71528-3	

105 **Einschubprofil 8,5 mm mit 7 mm Nase, Aluminium eloxiert, gebohrt**

insert profile 8,5 mm with 7 mm nose, aluminium anodized, drilled

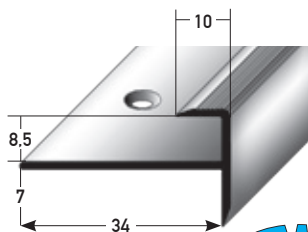

AUSKLINKEN & BIEGEN
notched + bent

silberfarbig silver	1.0	32140-8	
	2.7	32145-3	
goldfarbig gold	1.0	32155-2	
	2.7	32160-6	
bronzefarbig hell bronze light	1.0	32170-5	
	2.7	32175-0	
bronzefarbig dunkel bronze dark	1.0	32185-9	
	2.7	32190-3	
gold hell gold light	1.0	62175-1	
	2.7	62180-5	

32141-5	
32146-0	
32156-9	
32161-3	
32171-2	
32176-7	
32186-6	
32191-0	
62190-4	
62195-9	

AUSKLINKEN & BIEGEN
notched + bent

Befestigungsschenkel ausklinken attachment flanges notched
Befestigungsschenkel ausklinken und biegen attachment flanges notched and bent

Art. / ref.	€/ m
22240-8	
auf Anfrage on request	



5. EINSCHUB- UND ANSTOßPROFILE / 5. INSERT PROFILES

Andere Eloxalfarben siehe Abschnitt 6, Lieferzeit 14 Tage
other anodized colours see section 6, delivery time 14 days

Profi-Pack à 10 Stück im Bund			
professional packing à 10 pcs.			
Farbe/colour	L/l (m)	Art./ref.	€/Stk./pcs.

SB-Pack incl. Schr./Dübel: VE 20 Stk.	
self-service-pack with screws/dowels; à 20 pcs.	
Art./ref.	€/Stk./pcs.

265 Einschubprofil 8,5 mm mit 44 mm Nase, Aluminium eloxiert, gebohrt

insert profile 8.5 mm with 44 mm nose, aluminium anodized, drilled

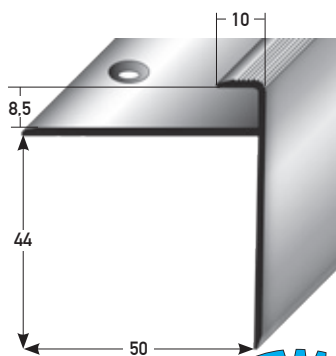

AUSKLINKEN & BIEGEN
notched + bent

silberfarbig silver	1.0	46234-7	
	2.7	46236-1	
goldfarbig gold	1.0	46248-4	
	2.7	46250-7	
bronzefarbig hell bronze light	1.0	46262-0	
	2.7	46264-4	
bronzefarbig dunkel bronze dark	1.0	46276-7	
	2.7	46278-1	
gold hell gold light	1.0	46438-9	
	2.7	46440-2	

46240-8	
46242-2	
46254-5	
46256-9	
46268-2	
46270-5	
46282-8	
46284-2	
46442-6	
46444-0	

262 Einschubprofil 10 mm mit 7 mm Nase, Aluminium eloxiert, gebohrt

insert profile 10 mm with 7 mm nose, aluminium anodized, drilled

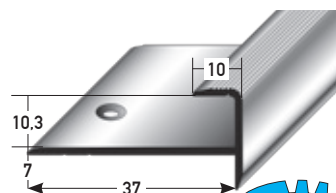

AUSKLINKEN & BIEGEN
notched + bent

silberfarbig silver	1.0	46122-7	
	2.7	46124-1	
goldfarbig gold	1.0	46136-4	
	2.7	46138-8	
bronzefarbig hell bronze light	1.0	46150-0	
	2.7	46152-4	
bronzefarbig dunkel bronze dark	1.0	46164-7	
	2.7	46166-1	
gold hell gold light	1.0	46448-8	
	2.7	46450-1	

46128-9	
46130-2	
46142-5	
46144-9	
46156-2	
46158-6	
46170-8	
46172-2	
46452-5	
46454-9	

427 Einschubprofil 10,5 mm mit 44 mm Nase, Aluminium eloxiert, gebohrt

insert profile 10.5 mm with 44 mm nose, aluminium anodized, drilled

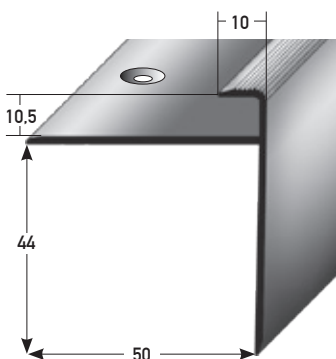

AUSKLINKEN & BIEGEN
notched + bent

silberfarbig silver	1.0	67100-8	
	2.7	67102-2	
goldfarbig gold	1.0	67104-6	
	2.7	67106-0	
bronzefarbig hell bronze light	1.0	67112-1	
	2.7	67114-5	
bronzefarbig dunkel bronze dark	1.0	67116-9	
	2.7	67118-3	
gold hell gold light	1.0	67108-4	
	2.7	67110-7	

67124-4	
67126-8	
67128-2	
67130-5	
67136-7	
67138-1	
67140-4	
67142-8	
67132-9	
67134-3	

AUSKLINKEN & BIEGEN
notched + bent

Befestigungsschenkel ausklinken attachment flanges notched
Befestigungsschenkel ausklinken und biegen attachment flanges notched and bent

Art./ref.	€/m
22240-8	
auf Anfrage on request	



Andere Eloxalfarben siehe Abschnitt 6. Lieferzeit 14 Tage
other anodized colours see section 6. delivery time 14 days

Profi-Pack à 10 Stück im Bund			
professional packing à 10 pcs.			
Farbe / colour	L / l (m)	Art. / ref.	€ / Stk. / pcs.

SB-Pack incl. Schr. / Dübel: VE 20 Stk.	
self-service-pack with screws / dowels: à 20 pcs.	
Art. / ref.	€ / Stk. / pcs.

263 Einschubprofil 13 mm mit 7 mm Nase, Aluminium eloxiert, gebohrt

insert profile 13 mm with 7 mm nose, aluminium anodized, drilled

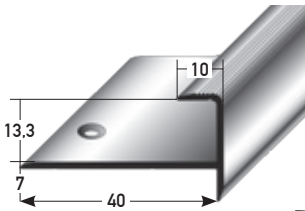

AUSKLINKEN & BIEGEN
notched + bent

silberfarbig silver	1.0	46178-4	
	2.7	46180-7	
goldfarbig gold	1.0	46192-0	
	2.7	46194-4	
bronzefarbig hell bronze light	1.0	46206-4	
	2.7	46208-8	
bronzefarbig dunkel bronze dark	1.0	46220-0	
	2.7	46222-4	
gold hell gold light	1.0	46458-7	
	2.7	46460-0	

46184-5	
46186-9	
46198-2	
46200-2	
46212-5	
46214-9	
46226-2	
46228-6	
46462-4	
46464-8	

112 Einschubprofil 15 mm mit 12 mm Nase, Aluminium eloxiert, gebohrt

insert profile 15.3 mm with 12 mm nose, aluminium anodized, drilled

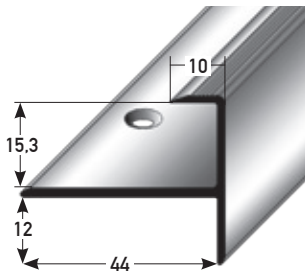

AUSKLINKEN & BIEGEN
notched + bent

silberfarbig silver	1.0	37020-8	
	2.7	37030-7	
goldfarbig gold	1.0	37040-6	
	2.7	37050-5	
bronzefarbig hell bronze light	1.0	37060-4	
	2.7	37070-3	
bronzefarbig dunkel bronze dark	1.0	37080-2	
	2.7	37090-1	
gold hell gold light	1.0	62210-9	
	2.7	62215-4	

37021-5	
37031-4	
37041-3	
37051-2	
37061-1	
37071-0	
37081-9	
37091-8	
62220-8	
62230-7	

AUSKLINKEN & BIEGEN
notched + bent

Befestigungsschenkel ausklinken attachment flanges notched
Befestigungsschenkel ausklinken und biegen attachment flanges notched and bent

Art. / ref.	€/m
22240-8	
auf Anfrage on request	



Andere Eloxalfarben siehe Abschnitt 6, Lieferzeit 14 Tage
other anodized colours see section 6, delivery time 14 days

Profi-Pack à 10 Stück im Bund

professional packing à 10 pcs.

Farbe/colour	L/l (m)	Art./ref.	€/Stk./pcs.
--------------	---------	-----------	-------------

SB-Pack incl. Schr./Dübel: VE 20 Stk.

self-service-pack with screws/dowels; à 20 pcs.

Art./ref.	€/Stk./pcs.
-----------	-------------

101 Treppenkante für Laminat, 20 x 33 x 8,5 mm, Aluminium eloxiert, 2 x gebohrt

stair nosing for laminate
20 x 33 x 8,5 mm, aluminium anodized,
2 x drilled

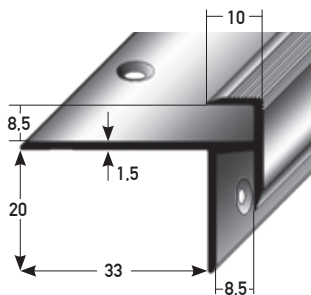

silberfarbig silver	1.0	29100-8			29101-5	
	2.5	29110-7			29111-4	
goldfarbig gold	1.0	29115-2			29116-9	
	2.5	29125-1			29126-8	
bronzefarbig hell bronze light	1.0	29130-5			29131-2	
	2.5	29140-4			29141-1	
bronzefarbig dunkel bronze dark	1.0	29145-9			29146-6	
	2.5	29155-8			29156-5	
gold hell gold light	1.0	62300-7			62315-1	
	2.5	62310-6			62320-5	

259 Treppenkante für Parkett, 20 x 33 x 10 mm, Aluminium eloxiert, 2 x gebohrt

stair nosing for parquet
20 x 33 x 10 mm, aluminium anodized,
2 x drilled

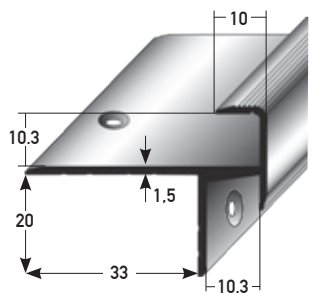

silberfarbig silver	1.0	46288-0			46292-7	
	2.5	46290-3			46294-1	
goldfarbig gold	1.0	46298-9			46302-3	
	2.5	46300-9			46304-7	
bronzefarbig hell bronze light	1.0	46308-5			46312-2	
	2.5	46310-8			46314-6	
bronzefarbig dunkel bronze dark	1.0	46318-4			46322-1	
	2.5	46320-7			46324-5	
gold hell gold light	1.0	46408-2			46412-9	
	2.5	46410-5			46414-3	

260 Treppenkante für Parkett, 20 x 33 x 13 mm, Aluminium eloxiert, 2 x gebohrt

stair nosing for parquet
20 x 33 x 13 mm, aluminium anodized,
2 x drilled

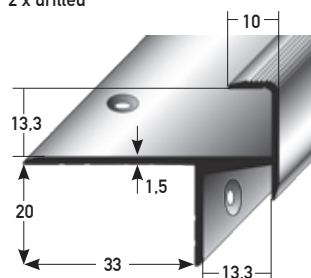

silberfarbig silver	1.0	46328-3			46332-0	
	2.5	46330-6			46334-4	
goldfarbig gold	1.0	46338-2			46342-9	
	2.5	46340-5			46344-3	
bronzefarbig hell bronze light	1.0	46348-1			46352-8	
	2.5	46350-4			46354-2	
bronzefarbig dunkel bronze dark	1.0	46358-0			46362-7	
	2.5	46360-3			46364-1	
gold hell gold light	1.0	46418-1			46422-8	
	2.5	46420-4			46424-2	

261 Treppenkante für Parkett, 20 x 33 x 15 mm, Aluminium eloxiert, 2 x gebohrt

stair nosing for parquet
20 x 33 x 15 mm, aluminium anodized,
2 x drilled

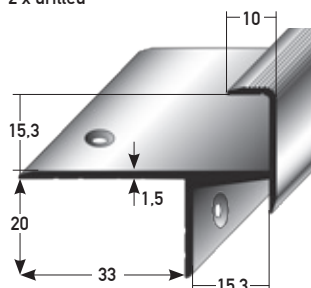

silberfarbig silver	1.0	46368-9			46372-6	
	2.5	46370-2			46374-0	
goldfarbig gold	1.0	46378-8			46382-5	
	2.5	46380-1			46384-9	
bronzefarbig hell bronze light	1.0	46388-7			46392-4	
	2.5	46390-0			46394-8	
bronzefarbig dunkel bronze dark	1.0	46398-6			46402-0	
	2.5	46400-6			46404-4	
gold hell gold light	1.0	46428-0			46432-7	
	2.5	46430-3			46434-1	



6. LED + SERVICE

6. LED + service

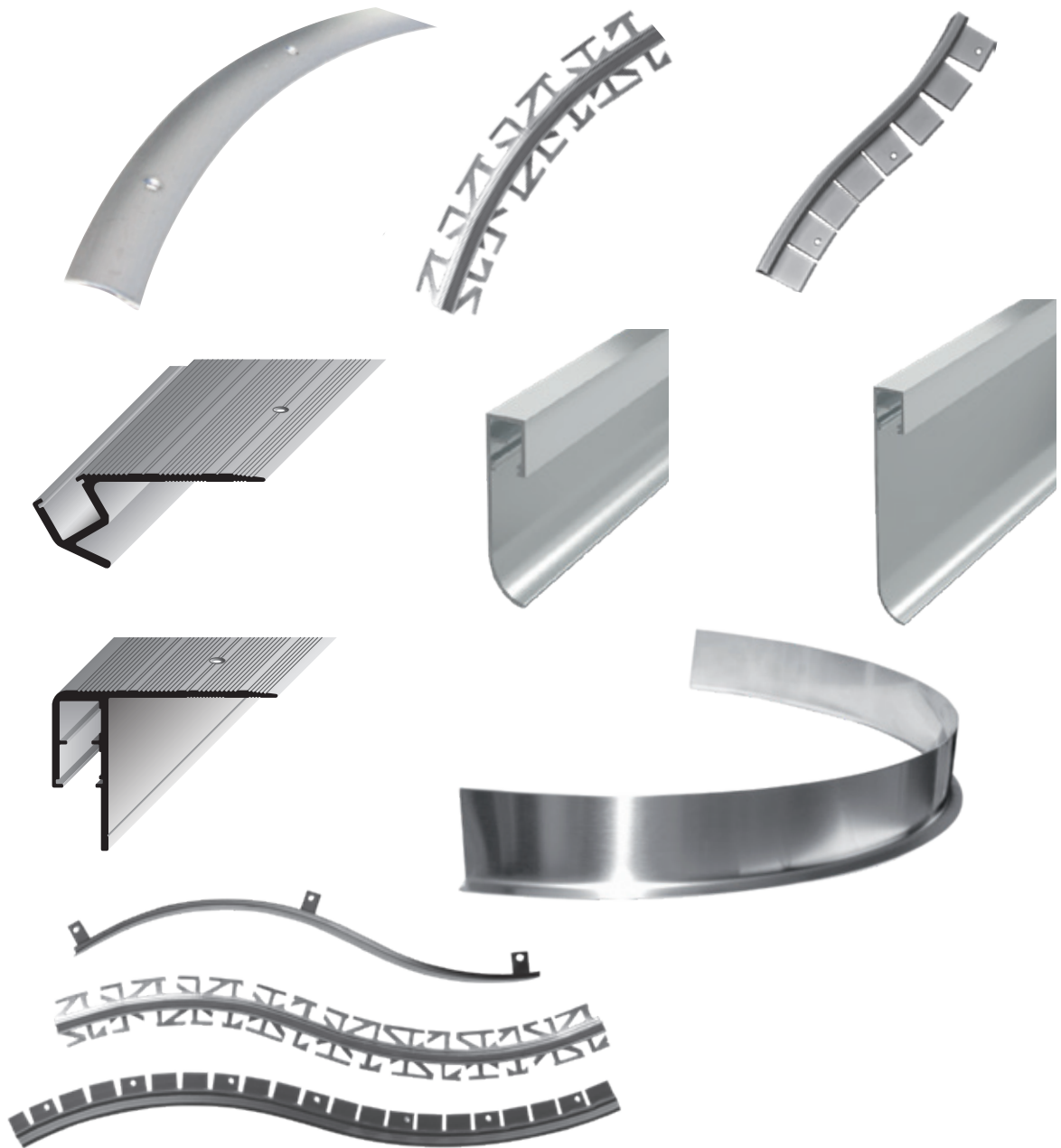

6



LED-beleuchtete Treppenkanten / LED-lighted stair nosings

Angebotserstellung erfolgt nach objektspezifischer Anfrage

offer by object-specific request

Farbe & Material / colour+material	Art./ ref.
------------------------------------	------------

309 Treppenkante 21 x 37 mm, für direkte Beleuchtung, Aluminum eloxiert, gebohrt

stair nosing 21 x 37 mm, for direct lighting, aluminum anodized, drilled

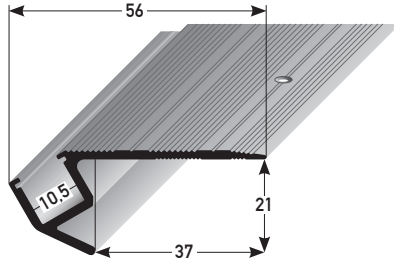

silberfarbig / silver	47990-1
goldfarbig / gold	47992-5
bronzefarbig hell / bronze light	47994-9
bronzefarbig dunkel / bronze dark	47996-3
edelstahlfarbig / stainless steel coloured	47998-7

513 Treppenkante 40 x 45 mm, für indirekte Beleuchtung, Aluminum eloxiert, gebohrt

stair nosing 40 x 45 mm, for indirect lighting, aluminum anodized, drilled

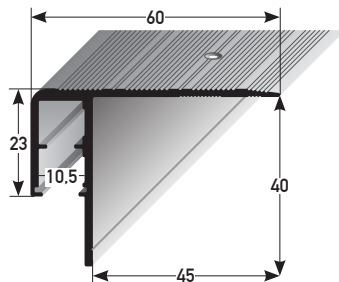

silberfarbig / silver	71754-6
goldfarbig / gold	71756-0
bronzefarbig hell / bronze light	71758-4
bronzefarbig dunkel / bronze dark	71760-7
edelstahlfarbig / stainless steel coloured	71762-1

Abdeckung zum Einschieben in die Treppenkante

cover to slide into the stair nosing

PVC-Rohr 10 x 10 mm	transparent / transparent	48010-5
	rot / red	48008-2
PVC-pipe 10 x 10 mm	grün / green	48006-8
	gelb / yellow	48002-0

PVC-Streifen 12 mm, transluzent PVC-stripe 12 mm, translucent	71764-5
--	---------

LED-Beleuchtungsstreifen, selbstklebend

LED-lighting strip, self-adhesive

12 V, warmweiß 10 LED/lfm., alle 3 LED/25 cm teilbar / 12 V, warm white 10 LED/m, every 3 LED/25 cm divisible	48014-3
12 V, warmweiß 30 LED/lfm., 8 mm breit, alle 3 LED/ 10 cm teilbar / 12 V, warm white 30 LED/m, 8 mm wide every 3 LED/10 cm divisible	48016-7
24 V, warmweiß ca. 500 LED/lfm., 10 mm breit, alle 4,2 cm teilbar / 24 V, warm white, approx. 500 LED/m, 10 mm wide, every 4,2 cm divisible	71966-3

Stromanschlussvarianten / power connector variants

Die Wahl des Netzteils ist abhängig von den LED's.

The choice of the power supply depends also on the LED's.

Steckernetzteil 24 W / power supply 24 W	48026-6
Steckernetzteil 48 W / power supply 48 W	48028-0
Einbaunetzteil 12 W / built-in power supply 12 W	48030-3
Einbaunetzteil 60 W / built-in power supply 60 W	48032-7
Einbaunetzteil 100 W / built-in power supply 100 W	48034-1

Dienstleistung / service

Rundum-Sorglos-Paket: wir liefern aufschraubfertig! Anschlusskabel gelötet inkl. seitl. Abdeckkappen / All-round carefree package: we deliver ready-to-screw! Connection cable soldered, including side caps	48038-9
---	---------



Sockelleisten mit LED-Beleuchtung / skirting with LED lighting

Komponentenauswahl / component selection:

Farbe / colour	L / l (m)	Art. / ref.	€/m
----------------	-----------	-------------	-----

514 Sockelleiste 60 mm, für indirekte LED-Beleuchtung, Aluminum eloxiert, ungebohrt

skirting 60 mm, for indirect LED lighting, aluminum anodized, undrilled

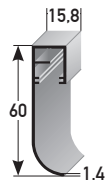

silberfarbig / silver	2,5	71768-3	
Pulvern nach RAL; Preis ab 150 lfm. powder RAL: price from 150 m		71770-6	
		Pulvern nach RAL unter 150 lfm. auf Anfrage powdered (RAL) less than 150m on request	

Sockelleiste mit 2 Kanälen: 1x für Stromversorgung + 1x für LED-Beleuchtung
skirting with 2 channels: 1x for power supply + 1x for LED lighting

515 Sockelleiste 100 mm, für indirekte LED-Beleuchtung, Aluminum eloxiert, ungebohrt

skirting 100 mm, for indirect LED lighting, aluminum anodized, undrilled

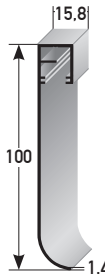

silberfarbig / silver	2,5	71774-4	
Pulvern nach RAL; Preis ab 150 lfm. powder RAL: price from 150 m		71776-8	
		Pulvern nach RAL unter 150 lfm. auf Anfrage powdered (RAL) less than 150m on request	

Sockelleiste mit 2 Kanälen: 1x für Stromversorgung + 1x für LED-Beleuchtung
skirting with 2 channels: 1x for power supply + 1x for LED lighting

LED-Beleuchtungsstreifen, selbstklebend

LED lighting strip self-adhesive

12 V, warmweiß 30 LED / lfm., 8 mm breit, alle 3 LED / 10 cm teilbar 12 V, warm white 30 LED / m, 8 mm wide, every 3 LED / 10 cm divisible	48016-7	Preis auf Anfrage price on request
24 V, warmweiß ca. 500 LED / lfm., 10 mm breit, alle 4,2 cm teilbar 24 V, warm white, approx. 500 LED / m, 10 mm wide, every 4,2 cm divisible	71966-3	

Eckverbinder für LED-Streifen

LED corner connector

4-poliger Eckverbinder für 8 und 10 mm breite LED-Streifen 4-pole corner connector for 8 and 10 mm wide LED strips	71860-4	Preis auf Anfrage price on request
---	---------	---------------------------------------

Kühlstreifen 10 x 1 mm

cooling strips 10 x 1 mm

optional zum Aufkleben der LEDs, 1.0 m optional for gluing the LEDs, 1.0 m	71864-2	
---	---------	--

transluzente Abdeckung zum Einschieben

translucent cover to slide in

PVC-Streifen 12 mm, transluzent, Rolle à 25 m PVC-stripe 12 mm, translucent, roll a 25 m	71764-5	
---	---------	--

Für Zuschnitte erheben wir einen Arbeitsaufschlag von 15 %.
For cuttings we charge a labor surcharge of 15%.

Stromanschlussvarianten

power connector variants

Die Wahl des Netzteils ist abhängig von der LED-Streifenlänge.

The choice of the power supply depends from the LED strip length.

Steckernetzteil 24 W / power supply 24 W	48026-6	Preis auf Anfrage price on request
Steckernetzteil 48 W / power supply 48 W	48028-0	
Einbaunetzteil 12 W / built-in power supply 12 W	48030-3	
Einbaunetzteil 60 W / built-in power supply 60 W	48032-7	
Einbaunetzteil 100 W / built-in power supply 100 W	48034-1	





Serviceleistungen für unsere Kunden / services for our customers

- 

Sonderlängenzuschnitt, Längsteilen von Profilen, Profile ohne Bohrungen oder pressblank, Sonderbohrungen (Durchmesser + Bohrbilder + Lochabstand) auf Anfrage möglich
 special length cuts, lengthwise cutting of profiles, profiles without holes or mill finish and special drilling (diameter / drilling patterns / hole spacing)
- 

andere Farben und Oberflächen auf Anfrage: andere Eloxalfarben (gold hell, schwarz, edelstahlfarbig), Pulverbeschichten nach RAL, Emaillieren, Brünieren, Vergolden, Zaponlackieren
 other colours and surfaces on request: other anodized colours (gold light, black, stainless steel coloured), powder coating according to RAL, enamelling, brass burnished, gilding, zapon varnishing
- 

Mattschleifen, Anphasen, Gehrungsschnitte, Rahmenfertigung, Profilmfertigung nach Skizze, Laserbearbeitung von Edelstahl, Messing, Aluminium und Kupfer, Laserschweißen
 matt grinding, chamfering, miter cuts, frame production, profile production according to sketch, laser processing of stainless steel, brass, aluminum and copper, laser welding
- 

Biegen von Profilen nach Schablone oder Radiusangabe (nach vorheriger Absprache)
 bending of profiles with template or radius specification (by prior arrangement)
- 

Einschweißen von Profilen
 profiles shrink-wrapped in foil

und vieles mehr
 and much more

Technische Datenblätter, Verlegehinweise, Materialbeschreibungen und Pflegehinweise erhalten Sie auf Anfrage oder unter www.Auer-Metallprofile.de

Technical details, installation tips, material descriptions and care instructions are available on request or under www.Auer-Metallprofile.de

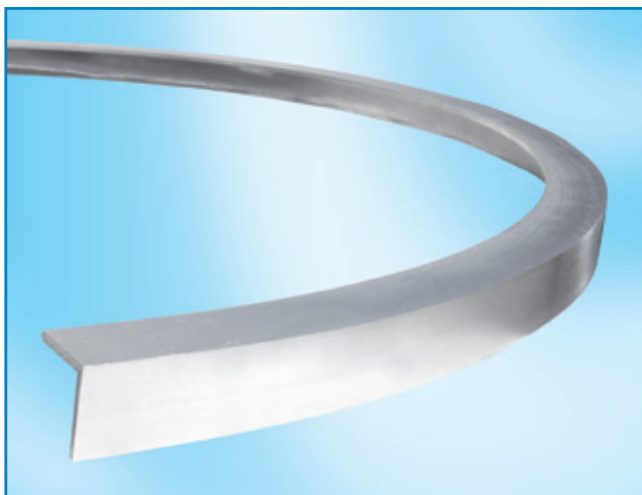

Beispiel:
Aluminium-Winkelprofil gebogen
example:
aluminium angle edge bent

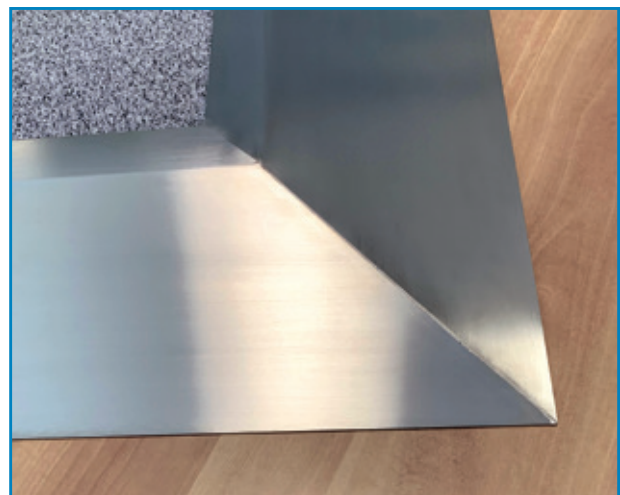

Beispiel:
Edelstahl-Niveauausgleichsecke, feingeschweißt
example:
stainless steel level compensation corner, finely welded





Befestigungsschenkel ausklinken attachment flanges notched

doppelte Anzahl Bohrlöcher / twice the number of drill holes

Art. / ref.	€/m
22240-8	

Profile können in Radien größer ca. 3,0 m vor Ort gebogen werden.
Profiles with radius larger than 3,0 m can be bent at installation location.

zusätzlich zum Materialpreis
in addition to the material price

Von Profil zu Profil können große Unterschiede in der Biegefähigkeit bestehen.
There may be substantial variations in the possibility of bending different profiles!

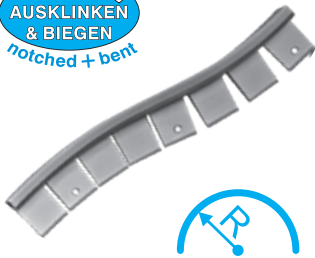

Die Aufbewahrungsfrist für Schablonen in Aue beträgt maximal 6 Monate!
Important: We keep templates in Aue for a max. of 6 months!

Befestigungsschenkel ausklinken und biegen attachment flanges notched and bent

Befestigungsschenkel für alle gängigen Einfass- und Einschubprofile ausklinken und Profil biegen nach Schablone, Skizze oder Radius.
Attachment flanges for all common insert profiles notched and bent according to template, sketch or radius.

Art. - Nr.	€/Radius radius
22241-5	

zusätzlich zum Materialpreis
in addition to the material price

Bitte immer die Biegerichtung mit angeben!
Please specify the bending direction!

Achtung! Bei Winkel- und Übergangprofilen kann der Biegeaufwand höher sein. Bitte extra anfragen!
Attention! For angles and connecting profiles the bending effort can be higher. Please inquire separately!

251 Säulenringe biegen

pillar ring bent

Fertigung in 2 Halbschalen
manufactured in two halves

Abbildung nur symbolhaft
illustration only symbolic



Ø mm	Art. - Nr.	€/Ring / pillar ring
Ø 200-300	45720-6	
Ø 301-400	45725-1	
Ø 401-500	45730-5	
Ø 501-X	45735-0	

zusätzlich zum Materialpreis
in addition to the material price

Dehnungsfugenprofil gebogen
expansion gap profile, bent

Einschubprofil mit Nase aus Edelstahl, gebogen
stainless steel nosed insert profile, bent



Übergangprofil gebogen
connecting profile curved





7. Systemprofile aus Aluminium und Edelstahl für 4 - 24 mm Beläge

7. system profiles out of aluminium + stainless steel for 4-24 mm floorings

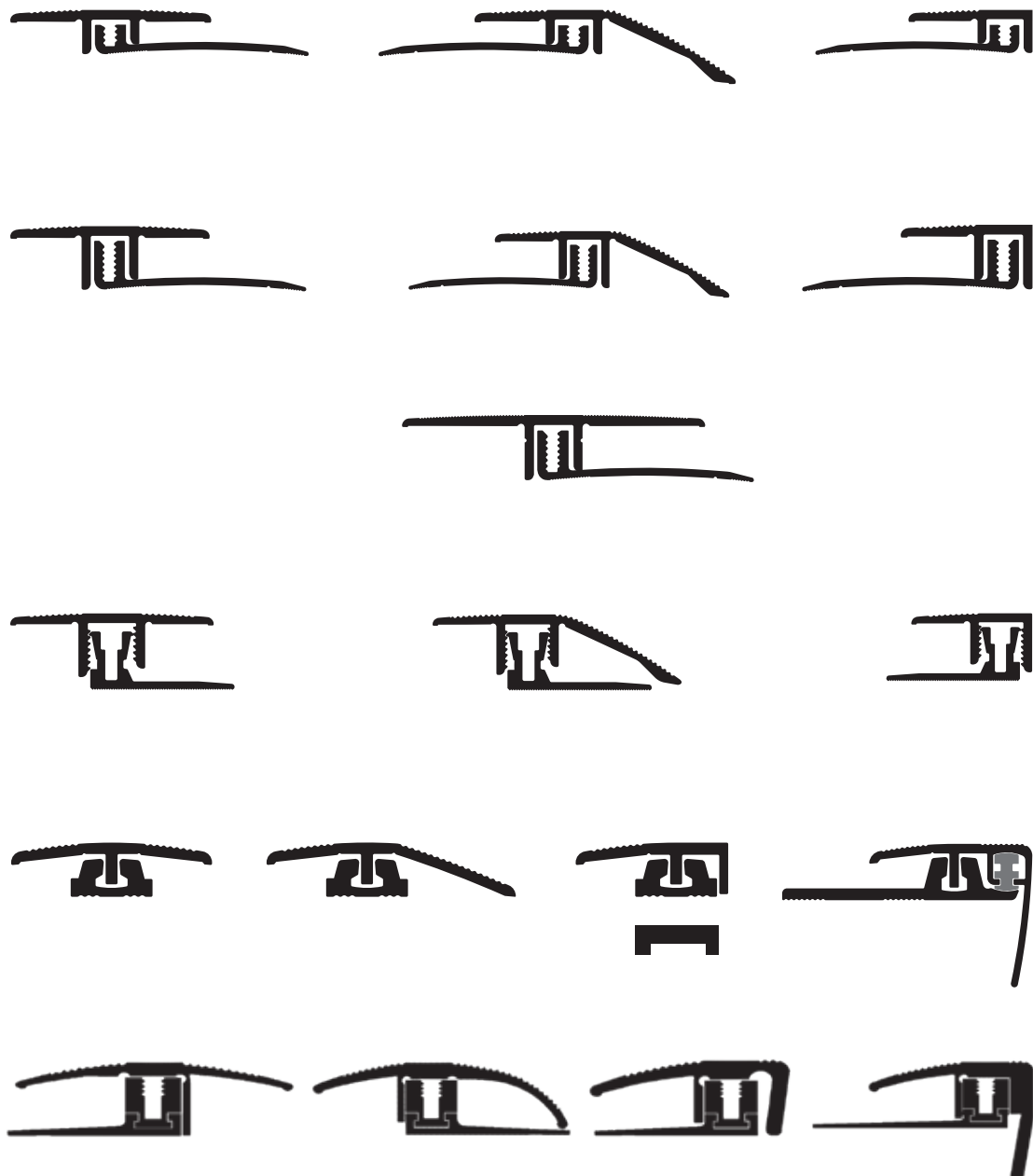

7



MINI-APL-System 5-9 mm, 2-teilig / MINI-APL-system 5-9 mm, 2 parts

306 MINI-APL-
Übergangsprofil,
5-9 mm, Aluminium,
gebohrt, mit 40 mm
breitem Grundprofil

MINI-APL-edge 5 - 9 mm, aluminium
drilled, with 40 mm wide basic profile

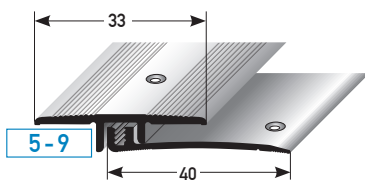

Zusätzliche Schrauben siehe Abschnitt 12.
Additional screws, see section 12.

SB-Pack inkl. Schrauben / Dübel: VE 20 Stück

self-service-pack with screws / dowels: à 20 pcs.

Farbe / colour	L / l (m)	Art. / ref.	€/Stk. / pcs.
silberfarbig silver	0,9	48776-0	
	1,0	48778-4	
	2,7	48780-7	
goldfarbig gold	0,9	48782-1	
	1,0	48784-5	
	2,7	48786-9	
bronzefarbig hell bronze light	0,9	48788-3	
	1,0	48790-6	
	2,7	48792-0	
bronzefarbig dunkel bronze dark	0,9	48794-4	
	1,0	48796-8	
	2,7	48798-2	
gold hell gold light	0,9	48800-2	
	1,0	48802-6	
	2,7	48804-0	
edelstahlfarbig stainless steel coloured	0,9	48806-4	
	1,0	48808-8	
	2,7	48810-1	

APL-System 7-15 mm, 2-teilig / APL-system 7-15 mm, 2 parts

255 APL-
Übergangsprofil,
7-15 mm, Aluminium,
gebohrt, mit 40 mm
breitem Grundprofil

APL - edge 7 - 15 mm, aluminium,
drilled, with 40 mm wide basic profile

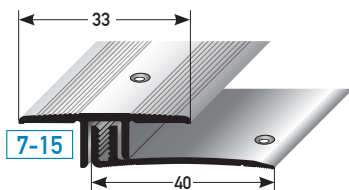

Extra Schrauben siehe Abschnitt 12.
Extra screws, see section 12.

**Grundprofilerhöhung,
siehe Seite 96**
basic profile increase
see page 96

silberfarbig silver	0,9	45944-6	
	1,0	45824-1	
	2,7	45800-5	
goldfarbig gold	0,9	45946-0	
	1,0	45826-5	
	2,7	45802-9	
bronzefarbig hell bronze light	0,9	45950-7	
	1,0	45830-2	
	2,7	45806-7	
bronzefarbig dunkel bronze dark	0,9	45952-1	
	1,0	45832-6	
	2,7	45808-1	
gold hell gold light	0,9	45948-4	
	1,0	45828-9	
	2,7	45804-3	
edelstahlfarbig stainless steel coloured	0,9	45964-4	
	1,0	45844-9	
	2,7	45820-3	

Holzdekorfolie/wood dekor	Buche beech	0,9	45954-5	
		1,0	45834-0	
		2,7	45810-4	
	Eiche oak	0,9	45956-9	
		1,0	45836-4	
		2,7	45812-8	
	Ahorn maple	0,9	45958-3	
		1,0	45838-8	
		2,7	45814-2	
Kirschbaum cherry wood	0,9	45960-6		
	1,0	45840-1		
	2,7	45816-6		
Eiche rustikal rustic oak	0,9	45962-0		
	1,0	45842-5		
	2,7	45818-0		

**20 mm breites Grundprofil für MINI-APL und APL
siehe Seite 96**

20 mm wide basic profile for MINI-APL + APL, see page 96

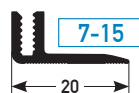

APL-System 7-15 mm, 2-teilig / APL-system 7-15 mm, 2 parts

499 APL- Übergangprofil
50 mm extrabreit,
7-15 mm, Aluminium,
gebohrt, mit 40 mm
breitem Grundprofil

APL-edge extra wide, 7 - 15 mm,
aluminium, drilled, with 40 mm wide
basic profile

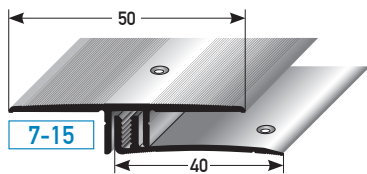

Zusätzliche Schrauben siehe Abschnitt 12.
Additional screws, see section 12.

SB-Pack inkl. Schrauben / Dübel; VE 20 Stück			
self-service-pack with screws / dowels; à 20 pcs.			
Farbe / colour	L / l (m)	Art. / ref.	€ / Stk. / pcs.
silberfarbig silver	0.9	71356-2	
	1.0	71358-6	
	2.7	71360-9	
goldfarbig gold	0.9	71362-3	
	1.0	71364-7	
	2.7	71366-1	
bronzefarbig hell bronze light	0.9	71368-5	
	1.0	71370-8	
	2.7	71372-2	
bronzefarbig dunkel bronze dark	0.9	71374-6	
	1.0	71376-0	
	2.7	71378-4	
gold hell gold light	0.9	71380-7	
	1.0	71382-1	
	2.7	71384-5	
edelstahlfarbig stainless steel coloured	0.9	71386-9	
	1.0	71388-3	
	2.7	71390-6	

516 20 mm breites MINI-APL-Grundprofil für 5 - 9 mm Beläge, Aluminium, gebohrt, ohne Schrauben / Dübel

20 mm wide MINI-APL-basic profile, for 5-9 mm
flooring, aluminium, drilled, without screws /
dowels

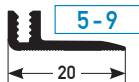

L / l (m)	Art. / ref.	€ / Stk. / pcs.
0.9	71788-1	
1.0	71790-4	
2.7	71792-8	

517 20 mm breites APL-Grundprofil für 7 - 15 mm Beläge, Aluminium, gebohrt, ohne Schrauben / Dübel

20 mm wide APL-basic profile, for 7-15 mm
flooring, aluminium, drilled, without
screws / dowels

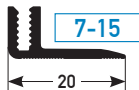

L / l (m)	Art. / ref.	€ / Stk. / pcs.
0.9	71780-5	
1.0	71782-9	
2.7	71784-3	

498 Grundprofilerrhöhung für APL- & SLP-System, PLA-3D, 2x gebohrt, inkl. Schrauben

basic profile increase for APL and
SLP system, PLA-3D, 2x drilled,
including screws

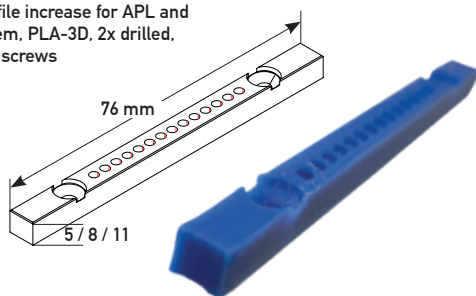

Höhe in mm height in mm	VE / unit	Art. / ref.	€ / Stk. / pcs.
5	10	71796-6	
8		71798-0	
11		71800-0	



MINI-APL-System 5-9 mm, 2-teilig / MINI-APL-system 5-9 mm, 2 parts

307

**MINI-APL-
Höhenausgleichsprofil,
5-9 mm, Aluminium,
gebohrt, mit 40 mm
breitem Grundprofil**

MINI-APL-height levelling 5 - 9 mm,
aluminium, drilled, with 40 mm
wide basic profile

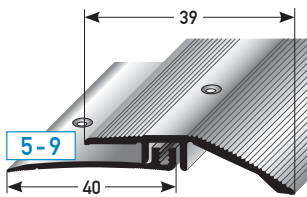

Extra Schrauben siehe Abschnitt 12.
Extra screws, see section 12.

SB-Pack inkl. Schrauben / Dübel: VE 20 Stück

self-service-pack with screws / dowels: à 20 pcs.

Farbe / colour	L / l (m)	Art. / ref.	€/Stk. / pcs.
silberfarbig silver	0.9	48856-9	
	1.0	48858-3	
	2.7	48860-6	
goldfarbig gold	0.9	48862-0	
	1.0	48864-4	
	2.7	48866-8	
bronzefarbig hell bronze light	0.9	48868-2	
	1.0	48870-5	
	2.7	48872-9	
bronzefarbig dunkel bronze dark	0.9	48874-3	
	1.0	48876-7	
	2.7	48878-1	
gold hell gold light	0.9	48880-4	
	1.0	48882-8	
	2.7	48884-2	
edelstahlfarbig stainless steel coloured	0.9	48886-6	
	1.0	48888-0	
	2.7	48890-3	

APL-System 7-15 mm, 2-teilig / APL-system 7-15 mm, 2 parts

256

**APL-
Höhenausgleichsprofil,
7-15 mm, Aluminium,
gebohrt, mit 40 mm
breitem Grundprofil**

APL-height levelling 7 - 15 mm,
aluminium, drilled, with 40 mm wide
basic profile

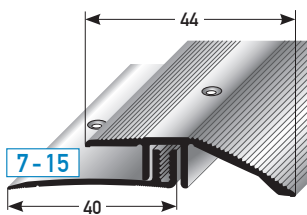

Zusätzliche Schrauben siehe Abschnitt 12.
Additional screws, see section 12.

silberfarbig silver	0.9	45966-8	
	1.0	45872-2	
	2.7	45848-7	
goldfarbig gold	0.9	45968-2	
	1.0	45874-6	
	2.7	45850-0	
bronzefarbig hell bronze light	0.9	45972-9	
	1.0	45878-4	
	2.7	45854-8	
bronzefarbig dunkel bronze dark	0.9	45974-3	
	1.0	45880-7	
	2.7	45856-2	
gold hell gold light	0.9	45970-5	
	1.0	45876-0	
	2.7	45852-4	
edelstahlfarbig stainless steel coloured	0.9	45986-6	
	1.0	45892-0	
	2.7	45868-5	

**Grundprofilerhöhung
siehe Seite 96**
basic profile increase
see page 96

Holzdekorfolie/wood dekor	Buche beech	0.9	45976-7	
		1.0	45882-1	
		2.7	45858-6	
	Eiche oak	0.9	45978-1	
		1.0	45884-5	
		2.7	45860-9	
	Ahorn maple	0.9	45980-4	
		1.0	45886-9	
		2.7	45862-3	
	Kirschbaum cherry wood	0.9	45982-8	
		1.0	45888-3	
		2.7	45864-7	
	Eiche rustikal rustic oak	0.9	45984-2	
		1.0	45890-6	
		2.7	45866-1	

**20 mm breites Grundprofil für MINI-APL und APL
siehe Seite 96**

20 mm wide basic profile for MINI-APL + APL, see page 96

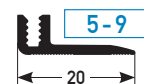
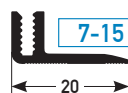

MINI-APL-System 5-9 mm, 2-teilig / MINI-APL-system 5-9 mm, 2 parts

SB-Pack inkl. Schrauben / Dübel; VE 20 Stück

self-service-pack with screws / dowels; à 20 pcs.

Farbe / colour	L / l (m)	Art. / ref.	€/Stk. / pcs.
silberfarbig silver	0.9	48936-8	
	1.0	48938-2	
	2.7	48940-5	
goldfarbig gold	0.9	48942-9	
	1.0	48944-3	
	2.7	48946-7	
bronzefarbig hell bronze light	0.9	48948-1	
	1.0	48950-4	
	2.7	48952-8	
bronzefarbig dunkel bronze dark	0.9	48954-2	
	1.0	48956-6	
	2.7	48958-0	
gold hell gold light	0.9	48960-3	
	1.0	48962-7	
	2.7	48964-1	
edelstahlfarbig stainless steel coloured	0.9	48966-5	
	1.0	48968-9	
	2.7	48970-2	

308 MINI-APL-
Abschlussprofil,
5-9 mm, Aluminium,
gebohrt, mit 40 mm
breitem Grundprofil

MINI-APL-end 5 - 9 mm, aluminium, drilled,
with 40 mm wide basic profile

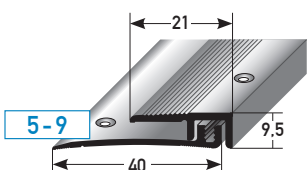

Extra Schrauben siehe Abschnitt 12.
Extra screws, see section 12.

APL-System 7-15 mm, 2-teilig / APL-system 7-15 mm, 2 parts

257 APL-
Abschlussprofil,
7-15 mm, Aluminium,
gebohrt, mit 40 mm
breitem Grundprofil

APL-end 7 - 15 mm, aluminium, drilled,
with 40 mm wide basic profile

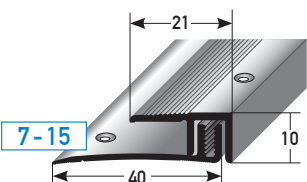

Zusätzliche Schrauben siehe Abschnitt 12.
Additional screws, see section 12.

silberfarbig silver	0.9	45988-0	
	1.0	45920-0	
	2.7	45896-8	
goldfarbig gold	0.9	45990-3	
	1.0	45922-4	
	2.7	45898-2	
bronzefarbig hell bronze light	0.9	45994-1	
	1.0	45926-2	
	2.7	45902-6	
bronzefarbig dunkel bronze dark	0.9	45996-5	
	1.0	45928-6	
	2.7	45904-0	
gold hell gold light	0.9	45992-7	
	1.0	45924-8	
	2.7	45900-2	
edelstahlfarbig stainless steel coloured	0.9	46008-4	
	1.0	45940-8	
	2.7	45916-3	

Holzdekorfolie/wood dekor	Buche beech	0.9	45998-9	
		1.0	45930-9	
		2.7	45906-4	
	Eiche oak	0.9	46000-8	
		1.0	45932-3	
		2.7	45908-8	
	Ahorn maple	0.9	46002-2	
		1.0	45934-7	
		2.7	45910-1	
	Kirschbaum cherry wood	0.9	46004-6	
		1.0	45936-1	
		2.7	45912-5	
	Eiche rustikal rustic oak	0.9	46006-0	
		1.0	45938-5	
		2.7	45914-9	

**20 mm breites Grundprofil für MINI-APL und APL
siehe Seite 96**

20 mm wide basic profile for MINI-APL + APL, see page 96

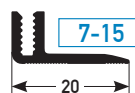

MINI-APL-KLICK-System 4-7 mm, 2-teilig / MINI-APL-CLICK-system 4-7 mm, 2 parts

447 MINI-APL-KLICK-Übergangsprofil, 4-7 mm, zum Klicken, Aluminium

MINI-APL-click-edge 4-7 mm, to click, aluminium

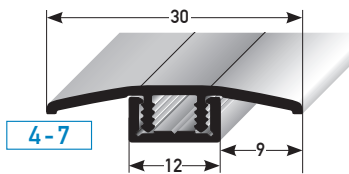

SB-Pack inkl. Schrauben / Dübel: VE 20 Stück self-service-pack with screws / dowels: à 20 pcs.			
Farbe / colour	L / l (m)	Art. / ref.	€/Stk. / pcs.
silberfarbig silver	0,9	68396-4	
	1,0	68398-8	
	2,7	68400-8	
goldfarbig gold	0,9	68402-2	
	1,0	68404-6	
	2,7	68406-0	
bronzefarbig hell bronze light	0,9	68408-4	
	1,0	68410-7	
	2,7	68412-1	
bronzefarbig dunkel bronze dark	0,9	68414-5	
	1,0	68416-9	
	2,7	68418-3	
gold hell gold light	0,9	68420-6	
	1,0	68422-0	
	2,7	68424-4	
edelstahlfarbig / AL-INOX stainless steel coloured	0,9	68426-8	
	1,0	68428-2	
	2,7	68430-5	

APL-KLICK-System 7-10 mm, 2-teilig / APL-CLICK-system 7-10 mm, 2 parts

272 APL-Klick-Übergangsprofil, 7-10 mm, zum Klicken, Aluminium

APL-click-edge 7-10 mm, to click, aluminium

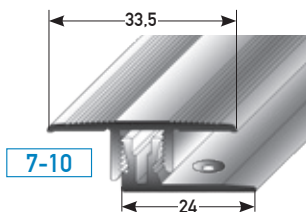

Für 7-10 mm Beläge + 2 mm Dämmung
for 7-10 mm coverings + 2 mm insulation

silberfarbig silver	0,9	48300-7	
	1,0	48302-1	
	2,7	48304-5	
goldfarbig gold	0,9	48306-9	
	1,0	48308-3	
	2,7	48310-6	
bronzefarbig hell bronze light	0,9	48312-0	
	1,0	48314-4	
	2,7	48316-8	
bronzefarbig dunkel bronze dark	0,9	48318-2	
	1,0	48320-5	
	2,7	48322-9	
gold hell gold light	0,9	48324-3	
	1,0	48326-7	
	2,7	48328-1	
edelstahlfarbig / AL-INOX stainless steel coloured	0,9	48330-4	
	1,0	48332-8	
	2,7	48334-2	

Holzdekorfolie / wood dekor	Buche beech	0,9	48336-6	
		1,0	48338-0	
		2,7	48340-3	
	Eiche oak	0,9	48342-7	
		1,0	48344-1	
		2,7	48346-5	
	Ahorn maple	0,9	48348-9	
		1,0	48350-2	
		2,7	48352-6	
Kirschbaum cherry wood	0,9	48354-0		
	1,0	48356-4		
	2,7	48358-8		
Eiche rustikal rustic oak	0,9	48360-1		
	1,0	48362-5		
	2,7	48364-9		

APL-KLICK-System 11 - 15 mm, 2-teilig / APL-CLICK-system 11 - 15 mm, 2 parts

273 APL-KLICK-
Übergangprofil
11 - 15 mm, zum Klicken,
Aluminium

APL-click-edge 11 - 15 mm, to click,
aluminium

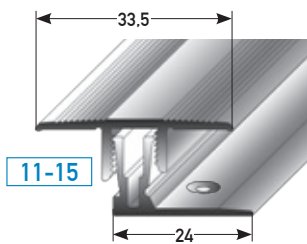

SB-Pack inkl. Schrauben / Dübel; VE 20 Stück self-service-pack with screws / dowels; à 20 pcs.			
Farbe / colour	L / l (m)	Art. / ref.	€/Stk. / pcs.
silberfarbig silver	0.9	48378-6	
	1.0	48380-9	
	2.7	48382-3	
goldfarbig gold	0.9	48384-7	
	1.0	48386-1	
	2.7	48388-5	
bronzefarbig hell bronze light	0.9	48390-8	
	1.0	48392-2	
	2.7	48394-6	
bronzefarbig dunkel bronze dark	0.9	48396-0	
	1.0	48398-4	
	2.7	48400-4	
gold hell gold light	0.9	48402-8	
	1.0	48404-2	
	2.7	48406-6	
edelstahlfarbig / AL-INOX stainless steel coloured	0.9	48408-0	
	1.0	48410-3	
	2.7	48412-7	

Holzdekorfolie / wood dekor	Buche beech	0.9	48414-1	
		1.0	48416-5	
		2.7	48418-9	
	Eiche oak	0.9	48420-2	
		1.0	48422-6	
		2.7	48424-0	
	Ahorn maple	0.9	48426-4	
		1.0	48428-8	
		2.7	48430-1	
	Kirschbaum cherry wood	0.9	48432-5	
		1.0	48434-9	
		2.7	48436-3	
	Eiche rustikal rustic oak	0.9	48438-7	
		1.0	48440-0	
		2.7	48442-4	

APL-KLICK-System 15 - 24 mm, 2-teilig / APL-CLICK-system 15 - 24 mm, 2 parts

448 APL-KLICK-
Übergangprofil,
15 - 24 mm, zum Klicken,
Aluminium

APL-click-edge 15-24 mm, to click,
aluminium

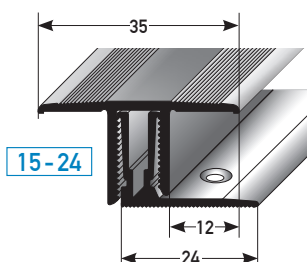

silberfarbig silver	0.9	68440-4	
	1.0	68442-8	
	2.7	68444-2	
goldfarbig gold	0.9	68446-6	
	1.0	68448-0	
	2.7	68450-3	
bronzefarbig hell bronze light	0.9	68452-7	
	1.0	68454-1	
	2.7	68456-5	
bronzefarbig dunkel bronze dark	0.9	68458-9	
	1.0	68460-2	
	2.7	68462-6	
gold hell gold light	0.9	68464-0	
	1.0	68466-4	
	2.7	68468-8	
edelstahlfarbig / AL-INOX stainless steel coloured	0.9	68470-1	
	1.0	68472-5	
	2.7	68474-9	

MINI-APL-KLICK-System 4-7 mm, 2-teilig / MINI-APL-CLICK-system 4-7 mm, 2 parts

449

**MINI-APL-KLICK-
Höhenausgleichsprofil,
4-7 mm, zum Klicken,
Aluminium**

MINI-APL-click-height levelling
4-7 mm, to click, aluminium

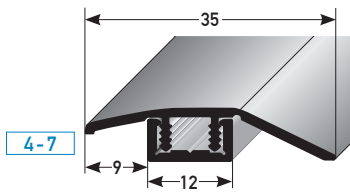

SB-Pack inkl. Schrauben / Dübel; VE 20 Stück

self-service-pack with screws / dowels; à 20 pcs.

Farbe / colour	L / l (m)	Art. / ref.	€/Stk. / pcs.
silberfarbig silver	0,9	68484-8	
	1,0	68486-2	
	2,7	68488-6	
goldfarbig gold	0,9	68490-9	
	1,0	68492-3	
	2,7	68494-7	
bronzefarbig hell bronze light	0,9	68496-1	
	1,0	68498-5	
	2,7	68500-5	
bronzefarbig dunkel bronze dark	0,9	68502-9	
	1,0	68504-3	
	2,7	68506-7	
gold hell gold light	0,9	68508-1	
	1,0	68510-4	
	2,7	68512-8	
edelstahlfarbig / AL-INOX stainless steel coloured	0,9	68514-2	
	1,0	68516-6	
	2,7	68518-0	

APL-KLICK-System 7-10 mm, 2-teilig / APL-CLICK-system 7-10 mm, 2 parts

274

**APL-Klick-
Höhenausgleichsprofil,
7-10 mm, zum Klicken,
Aluminium**

APL-click-height levelling 7-10 mm,
to click, aluminium

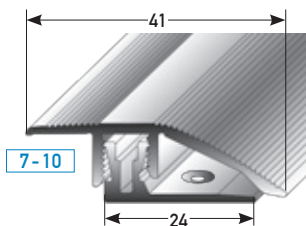

Für 7 - 10 mm Beläge + 2 mm
Dämmung
for 7 - 10 mm coverings + 2 mm
insulation

silberfarbig silver	0,9	48458-5	
	1,0	48460-8	
	2,7	48462-2	
goldfarbig gold	0,9	48464-6	
	1,0	48466-0	
	2,7	48468-4	
bronzefarbig hell bronze light	0,9	48470-7	
	1,0	48472-1	
	2,7	48474-5	
bronzefarbig dunkel bronze dark	0,9	48476-9	
	1,0	48478-3	
	2,7	48480-6	
gold hell gold light	0,9	48482-0	
	1,0	48484-4	
	2,7	48486-8	
edelstahlfarbig / AL-INOX stainless steel coloured	0,9	48488-2	
	1,0	48490-5	
	2,7	48492-9	

Holzdekorfolie / wood dekor	Buche beech	0,9	48494-3	
		1,0	48496-7	
		2,7	48498-1	
	Eiche oak	0,9	48500-1	
		1,0	48502-5	
		2,7	48504-9	
	Ahorn maple	0,9	48506-3	
		1,0	48508-7	
		2,7	48510-0	
	Kirschbaum cherry wood	0,9	48512-4	
		1,0	48514-8	
		2,7	48516-2	
	Eiche rustikal rustic oak	0,9	48518-6	
		1,0	48520-9	
		2,7	48522-3	



APL-KLICK-System 11-15 mm, 2-teilig / APL-CLICK-system 11 - 15 mm, 2 parts

275 APL-Klick-
Höhenausgleichsprofil,
11 - 15 mm, zum Klicken,
Aluminium

APL-click-height levelling 11 - 15 mm,
to click, aluminium

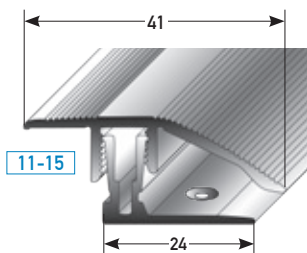

Für 11 - 15 mm Beläge + 2 mm
Dämmung
for 11 - 15 mm coverings + 2 mm
insulation

SB-Pack inkl. Schrauben / Dübel; VE 20 Stück

self-service-pack with screws / dowels; à 20 pcs.

Farbe / colour	L / l (m)	Art. / ref.	€/Stk. / pcs.
silberfarbig silver	0.9	48536-0	
	1.0	48538-4	
	2.7	48540-7	
goldfarbig gold	0.9	48542-1	
	1.0	48544-5	
	2.7	48546-9	
bronzefarbig hell bronze light	0.9	48548-3	
	1.0	48550-6	
	2.7	48552-0	
bronzefarbig dunkel bronze dark	0.9	48554-4	
	1.0	48556-8	
	2.7	48558-2	
gold hell gold light	0.9	48560-5	
	1.0	48562-9	
	2.7	48564-3	
edelstahlfarbig / AL-INOX stainless steel coloured	0.9	48566-7	
	1.0	48568-1	
	2.7	48570-4	

Holzdekorfolie / wood dekor	Buche beech	0.9	48572-8	
		1.0	48574-2	
		2.7	48576-6	
	Eiche oak	0.9	48578-0	
		1.0	48580-3	
		2.7	48582-7	
	Ahorn maple	0.9	48584-1	
		1.0	48586-5	
		2.7	48588-9	
	Kirschbaum cherry wood	0.9	48590-2	
		1.0	48592-6	
		2.7	48594-0	
	Eiche rustikal rustic oak	0.9	48596-4	
		1.0	48598-8	
		2.7	48600-8	

APL-KLICK-System 15-24 mm, 2-teilig / APL-CLICK-system 15 - 24 mm, 2 parts

450 APL-KLICK-
Höhenausgleichsprofil,
15 - 24 mm, zum Klicken,
Aluminium

APL-click-height levelling
15 - 24 mm, to click, aluminium

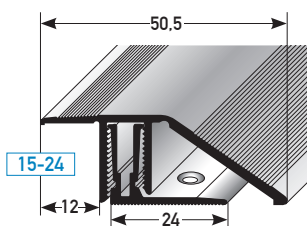

Für 15 - 24 mm-Beläge + 2 mm
Dämmung
for 15 - 24 mm coverings + 2 mm
insulation

silberfarbig silver	0.9	68528-9	
	1.0	68530-2	
	2.7	68532-6	
goldfarbig gold	0.9	68534-0	
	1.0	68536-4	
	2.7	68538-8	
bronzefarbig hell bronze light	0.9	68540-1	
	1.0	68542-5	
	2.7	68544-9	
bronzefarbig dunkel bronze dark	0.9	68546-3	
	1.0	68548-7	
	2.7	68550-0	
gold hell gold light	0.9	68552-4	
	1.0	68554-8	
	2.7	68556-2	
edelstahlfarbig / AL-INOX stainless steel coloured	0.9	68558-6	
	1.0	68560-9	
	2.7	68562-3	

MINI-APL-KLICK-System 4 - 7 mm, 2-teilig / MINI-APL-CLICK-system 4 - 7 mm, 2 parts

451

**MINI-APL-KLICK-
Abschlussprofil,
4 - 7 mm, zum Klicken,
Aluminium**

MINI-APL-click-end 4 - 7 mm,
to click, aluminium

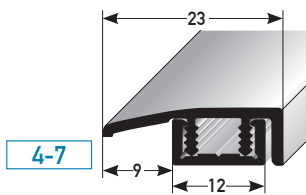

SB-Pack inkl. Schrauben / Dübel: VE 20 Stück

self-service-pack with screws / dowels: à 20 pcs.

Farbe / colour	L / l (m)	Art. / ref.	€/Stk. / pcs.
silberfarbig silver	0,9	68572-2	
	1,0	68574-6	
	2,7	68576-0	
goldfarbig gold	0,9	68578-4	
	1,0	68580-7	
	2,7	68582-1	
bronzefarbig hell bronze light	0,9	68584-5	
	1,0	68586-9	
	2,7	68588-3	
bronzefarbig dunkel bronze dark	0,9	68590-6	
	1,0	68592-0	
	2,7	68594-4	
gold hell gold light	0,9	68596-8	
	1,0	68598-2	
	2,7	68600-2	
edelstahlfarbig / AL-INOX stainless steel coloured	0,9	68602-6	
	1,0	68604-0	
	2,7	68606-4	

APL-KLICK-System 7 - 10 mm, 2-teilig / APL-CLICK-system 7 - 10 mm, 2 parts

276

**APL-Klick-
Abschlussprofil,
7 - 10 mm, zum Klicken,
Aluminium**

APL-click-end 7 - 10 mm, to click,
aluminium

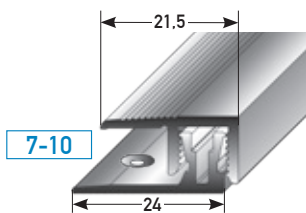

Für 7 - 10 mm Beläge + 2 mm
Dämmung
for 7 - 10 mm coverings + 2 mm
insulation

silberfarbig silver	0,9	48616-9	
	1,0	48618-3	
	2,7	48620-6	
goldfarbig gold	0,9	48622-0	
	1,0	48624-4	
	2,7	48626-8	
bronzefarbig hell bronze light	0,9	48628-2	
	1,0	48630-5	
	2,7	48632-9	
bronzefarbig dunkel bronze dark	0,9	48634-3	
	1,0	48636-7	
	2,7	48638-1	
gold hell gold light	0,9	48640-4	
	1,0	48642-8	
	2,7	48644-2	
edelstahlfarbig / AL-INOX stainless steel coloured	0,9	48646-6	
	1,0	48648-0	
	2,7	48650-3	

Holzdekorfolie / wood dekor	Buche beech	0,9	48652-7	
		1,0	48654-1	
		2,7	48656-5	
	Eiche oak	0,9	48658-9	
		1,0	48660-2	
		2,7	48662-6	
	Ahorn maple	0,9	48664-0	
		1,0	48666-4	
		2,7	48668-8	
Kirschbaum cherry wood	0,9	48670-1		
	1,0	48672-5		
	2,7	48674-9		
Eiche rustikal rustic oak	0,9	48676-3		
	1,0	48678-7		
	2,7	48680-0		

APL-KLICK-System 11-15 mm, 2-teilig / APL-CLICK-system 11 - 15 mm, 2 parts

SB-Pack inkl. Schrauben / Dübel; VE 20 Stück

self-service-pack with screws / dowels; à 20 pcs.

Farbe / colour	L / l (m)	Art. / ref.	€ / Stk. / pcs.
----------------	-----------	-------------	-----------------

277 APL-Klick-Abschlussprofil, 11-15 mm, zum Klicken, Aluminium

APL-click-end 11 - 15 mm, to click, aluminium

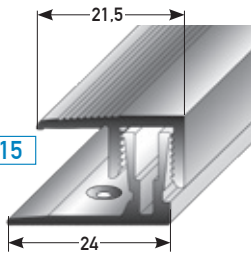

11-15

Für 11 - 15 mm Beläge + 2 mm Dämmung
for 11 - 15 mm coverings + 2 mm insulation

silberfarbig silver	0.9	48694-7	
	1.0	48696-1	
	2.7	48698-5	
goldfarbig gold	0.9	48700-5	
	1.0	48702-9	
	2.7	48704-3	
bronzefarbig hell bronze light	0.9	48706-7	
	1.0	48708-1	
	2.7	48710-4	
bronzefarbig dunkel bronze dark	0.9	48712-8	
	1.0	48714-2	
	2.7	48716-6	
gold hell gold light	0.9	48718-0	
	1.0	48720-3	
	2.7	48722-7	
edelstahlfarb. / AL-INOX stainless steel coloured	0.9	48724-1	
	1.0	48726-5	
	2.7	48728-9	

Holzdekorfolie / wood dekor	Buche beech	0.9	48730-2	
		1.0	48732-6	
		2.7	48734-0	
	Eiche oak	0.9	48736-4	
		1.0	48738-8	
		2.7	48740-1	
	Ahorn maple	0.9	48742-5	
		1.0	48744-9	
		2.7	48746-3	
	Kirschbaum cherry wood	0.9	48748-7	
		1.0	48750-0	
		2.7	48752-4	
	Eiche rustikal rustic oak	0.9	48754-8	
		1.0	48756-2	
		2.7	48758-6	



SKD-System für Klickdesign-Beläge 4-7 mm, flexibel, 2-teilig SKD - system for click design flooring 4-7 mm, flexible, 2 parts

SB-Pack inkl. Schrauben / Dübel; VE 20 Stück

self-service-pack with screws / dowels; à 20 pcs.

Farbe/colour	L/l (m)	Art./ref.	€/Stk./pcs.
--------------	---------	-----------	-------------

315 SKD-Übergangprofil für Klickdesign-Beläge für Höhe 4-7 mm, flexibel, Aluminium, gebohrt

SKD-edge for click design flooring
4-7 mm, flexible, aluminium, drilled

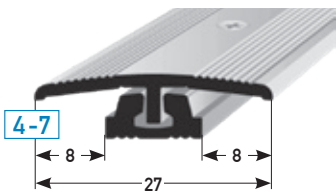

**Zusätzliche Schrauben
siehe Abschnitt 12.**
Additional screws, see section 12.

silberfarbig silver	0,9	49014-2	
	2,7	49016-6	
goldfarbig gold	0,9	49018-0	
	2,7	49020-3	
bronzefarbig hell bronze light	0,9	49064-7	
	2,7	49066-1	
goldfarbig hell gold light	0,9	49022-7	
	2,7	49024-1	
edelstahlfarbig stainless steel coloured	0,9	49026-5	
	2,7	49028-9	

316 SKD-Höhenausgleichsprofil für Klickdesign-Beläge für Höhe 4-7 mm, flexibel, Aluminium, gebohrt

SKD-height levelling for click design
flooring 4-7 mm, flexible, aluminium, drilled

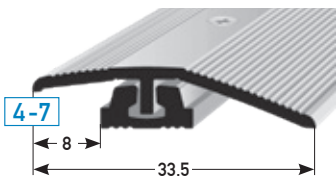

**Zusätzliche Schrauben
siehe Abschnitt 12.**
Additional screws, see section 12.

silberfarbig silver	0,9	49030-2	
	2,7	49032-6	
goldfarbig gold	0,9	49034-0	
	2,7	49036-4	
bronzefarbig hell bronze light	0,9	49068-5	
	2,7	49070-8	
goldfarbig hell gold light	0,9	49038-8	
	2,7	49040-1	
edelstahlfarbig stainless steel coloured	0,9	49042-5	
	2,7	49044-9	

317 SKD-Abschlussprofil für Klickdesign-Beläge für Höhe 4-7 mm, flexibel, Aluminium, gebohrt

SKD-end for click design flooring
4-7 mm, flexible, aluminium, drilled

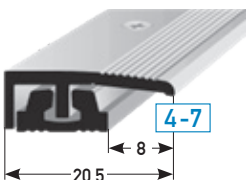

**Zusätzliche Schrauben
siehe Abschnitt 12.**
Additional screws, see section 12.

silberfarbig silver	0,9	49046-3	
	2,7	49048-7	
goldfarbig gold	0,9	49050-0	
	2,7	49052-4	
bronzefarbig hell bronze light	0,9	49072-2	
	2,7	49074-6	
goldfarbig hell gold light	0,9	49054-8	
	2,7	49056-2	
edelstahlfarbig stainless steel coloured	0,9	49058-6	
	2,7	49060-9	

327 SKD-Lifter 4 mm für Profilerhöhung auf 8-11 mm, PVC, gebohrt

SKD-lifter 4 mm, for increase
to 8 - 11 mm, PVC, drilled

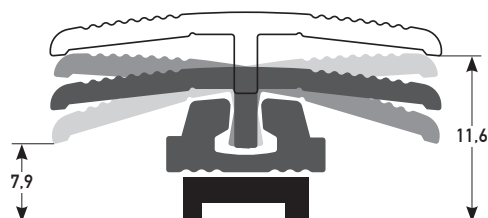
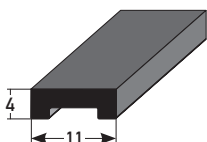

2,7	49062-3	
-----	---------	--



SKD-System für Klickdesign-Beläge 4-7 mm, flexibel, 2-teilig
 SKD - system for click design flooring 4-7 mm, flexible, 2 parts

SB-Pack inkl. Schrauben/Dübel; VE 20 Stück

self-service-pack with screws/dowels; à 20 pcs.

Farbe/colour	L/l (m)	Art./ref.	€/Stk./pcs.
--------------	---------	-----------	-------------

351 SKD-Treppenkante für Klickdesign-Beläge für Höhe 4-7 mm, flexibel, Aluminium, gebohrt

SKD-stair nosing for click design flooring
 4-7 mm, flexible, aluminium, drilled

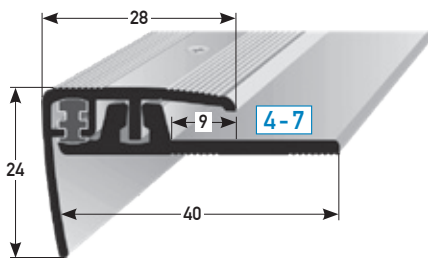

silberfarbig silver	0,9 2,7	49078-4 49088-3	
goldfarbig gold	0,9 2,7	49080-7 49090-6	
bronzefarbig hell bronze light	0,9 2,7	49086-9 49096-8	
goldfarbig hell gold light	0,9 2,7	49082-1 49092-0	
edelstahlfarbig stainless steel coloured	0,9 2,7	49084-5 49094-4	

Zusätzliche Schrauben siehe Abschnitt 12.
 Additional screws, see section 12.

SKD = System für Klickdesign-Beläge

SKD - system for click design flooring

7



Beispiel: SLP-System 7 - 17 mm + 12 - 22 mm (siehe Seite 107 - 109)
 example: SLP-system 7 - 17 mm + 12 - 22 mm (see page 107 - 109)



Beispiel: Mini-APL-System 5 - 9 mm (siehe Seite 95 - 98)
 example: Mini-APL-system 5 - 9 mm (see page 95 - 98)

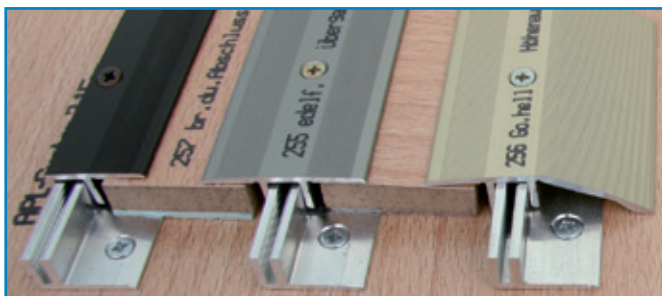

Beispiel: APL-System 7 - 15 mm (siehe Seite 95 - 98)
 example: APL-system 7 - 15 mm (see page 95 - 98)



Beispiel: APL-KLICK-System 4-7 / 7-10 / 11-15 / 15-24 mm
 (siehe Seite 99 - 104)
 example: APL-KLICK-system 4-7 / 7-10 / 11-15 / 15-24 mm
 (see page 99 - 104)



SLP-System 7-17 mm, flexibel, 3-teilig / SLP-system 7-17 mm, flexible 3 parts

138 SLP-Übergangprofil 35 mm für Laminat/Parkett 7-17 mm, flexibel, 3-teilig, Aluminium, gebohrt

SLP-edge 35 mm for laminate / wooden floors 7-17 mm,
flexible, 3 parts, aluminium, drilled

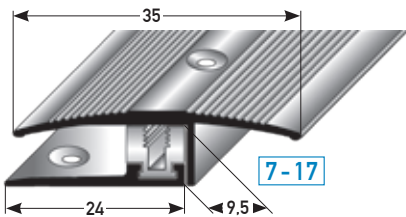

gleichzeitig Höhenausgleich
bis 5 mm
height levelling up to 5 mm



**Grundprofilerhöhung
siehe Seite 96**
basic profile increase
see page 96

Extra Schrauben siehe Abschnitt 12. / Extra screws, see section 12.

SB-Pack inkl. Schrauben/Dübel: VE 20 Stück

self-service-pack with screws/dowels: à 20 pcs.

Farbe/colour	L/l (m)	Art./ref.	€/Stk./pcs.
silberfarbig silver	0,9	42005-7	
	2,7	42000-2	
goldfarbig gold	0,9	42015-6	
	2,7	42010-1	
bronzefarbig hell bronze light	0,9	42025-5	
	2,7	42020-0	
gold hell gold light	0,9	62020-4	
	2,7	62025-9	

Holzdekorfolie/wood dekor	0,9		2,7	
	Buche beech	42045-3	42040-8	
Eiche oak	42055-2	42050-7		
Ahorn maple	42065-1	42060-6		
Kirschbaum cherry wood	43254-8	43256-2		
Eiche rustikal rustic oak	43258-6	43260-9		

139 SLP-Höhenausgleichsprofil 39 mm, für Laminat/Parkett 7-17 mm, flexibel, 3-teilig, Aluminium gebohrt

SLP-height levelling 39 mm for laminate / wooden floors
7-17 mm, flexible, 3 parts, aluminium, drilled

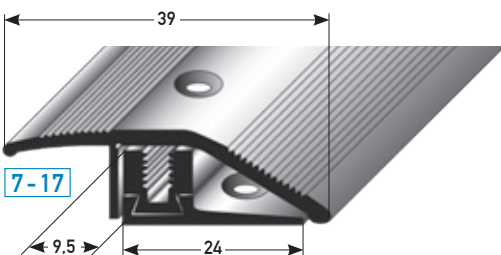

**Zusätzliche Schrauben
siehe Abschnitt 12.**
Additional screws,
see section 12.

**Grundprofilerhöhung
siehe Seite 96**
basic profile increase
see page 96

silberfarbig silver	0,9	42075-0	
	2,7	42070-5	
goldfarbig gold	0,9	42085-9	
	2,7	42080-4	
bronzefarbig hell bronze light	0,9	42095-8	
	2,7	42090-3	
gold hell gold light	0,9	62040-2	
	2,7	62045-7	

Holzdekorfolie/wood dekor	0,9		2,7	
	Buche beech	42115-3	42110-8	
Eiche oak	42125-2	42120-7		
Ahorn maple	42135-1	42130-6		
Kirschbaum cherry wood	43264-7	43266-1		
Eiche rustikal rustic oak	43268-5	43270-8		

140 SLP-Abschlussprofil 24 mm für Laminat/Parkett 7-17 mm, flexibel, 3-teilig, Aluminium, gebohrt

SLP-end 24 mm for laminate / wooden floors 7-17 mm,
flexible, 3 parts, aluminium, drilled

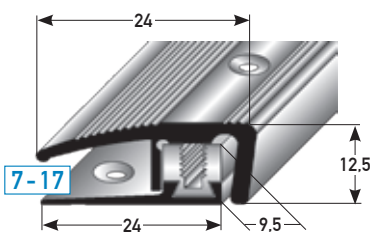

**Zusätzliche Schrauben
siehe Abschnitt 12.**
Additional screws,
see section 12.

silberfarbig silver	0,9	42145-0	
	2,7	42140-5	
goldfarbig gold	0,9	42155-9	
	2,7	42150-4	
bronzefarbig hell bronze light	0,9	42165-8	
	2,7	42160-3	
gold hell gold light	0,9	62060-0	
	2,7	62065-5	

Holzdekorfolie/wood dekor	0,9		2,7	
	Buche beech	42185-6	42180-1	
Eiche oak	42195-5	42190-0		
Ahorn maple	42205-1	42200-6		
Kirschbaum cherry wood	43274-6	43276-0		
Eiche rustikal rustic oak	43278-4	43280-7		



SLP-Treppenkante 7 - 15,5 mm, flexibel, 3-teilig / SLP-stair nosing 7 - 15,5 mm, flexible, 3 parts

SB-Pack inkl. Schrauben / Dübel; VE 20 Stück

self-service-pack with screws / dowels; à 20 pcs.

Farbe / colour	L/l (m)	Art. / ref.	€/Stk. / pcs.
----------------	---------	-------------	---------------

141 SLP-Treppenkante 28 mm für Laminat / Parkett, 7 - 15,5 mm, flexibel, 3-teilig, Aluminium, gebohrt

SLP-stair nosing 28 mm, for laminate / wooden floors 7 - 15,5 mm, flexible, 3 parts, aluminium, drilled

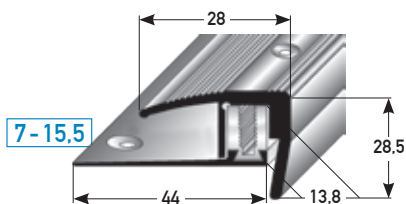

Zusätzliche Schrauben
siehe Abschnitt 12.
Additional screws, see section 12.

silberfarbig silver	0,9	41880-1	
	2,7	41890-0	
goldfarbig gold	0,9	41900-6	
	2,7	41910-5	
bronzefarbig hell bronze light	0,9	41920-4	
	2,7	41930-3	
gold hell gold light	0,9	62000-6	
	2,7	62005-1	

SLP-System für Parkett 12 - 22 mm, flexibel, 3-teilig / SLP-system for wooden floors 12 - 22 mm, flexible, 3 parts

164 SLP-Übergangprofil 35 mm, für Parkett, 12-22 mm, flexibel, 3-teilig, Aluminium, gebohrt

SLP-edge 35 mm for wooden floors 12-22 mm, flexible, 3 parts, aluminium, drilled

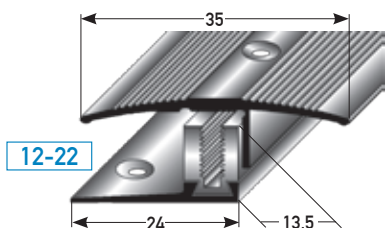

gleichzeitig Höhenausgleich
bis 5 mm
height levelling up to 5 mm

Grundprofilerhöhung
siehe Seite 96
basic profile increase
see page 96



Zusätzliche Schrauben siehe Abschnitt 12. / Additional screws, see section 12.

silberfarbig silver	0,9	43000-1	
	2,7	43002-5	
goldfarbig gold	0,9	43004-9	
	2,7	43006-3	
bronzefarbig hell bronze light	0,9	43008-7	
	2,7	43010-0	
gold hell gold light	0,9	43012-4	
	2,7	43014-8	

Holzdekorfolie / wood dekor	Buche beech	0,9	43016-2	
		2,7	43018-6	
Eiche oak		0,9	43020-9	
		2,7	43022-3	
Ahorn maple		0,9	43024-7	
		2,7	43026-1	
Kirschbaum cherry wood		0,9	43028-5	
		2,7	43030-8	
Eiche rustikal rustic oak		0,9	43032-2	
		2,7	43034-6	

153 SLP-Höhenausgleichsprofil 50 mm, für Parkett, 12-22 mm, flexibel, 3-teilig, Aluminium, gebohrt

SLP-height levelling 50 mm for wooden floors, 12 - 22 mm, flexible, 3 parts, aluminium, drilled

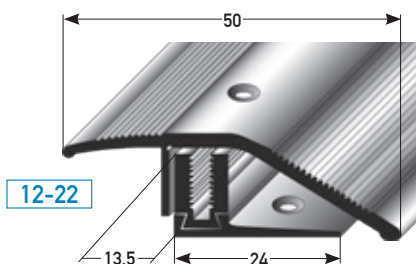

Zusätzliche Schrauben
siehe Abschnitt 12.
Additional screws,
see section 12.

Grundprofilerhöhung
siehe Seite 96
basic profile increase
see page 96

silberfarbig silver	0,9	43046-9	
	2,7	43048-3	
goldfarbig gold	0,9	43050-6	
	2,7	43052-0	
bronzefarbig hell bronze light	0,9	43054-4	
	2,7	43056-8	
gold hell gold light	0,9	43058-2	
	2,7	43060-5	

Holzdekorfolie / wood dekor	Buche beech	0,9	43062-9	
		2,7	43064-3	
Eiche oak		0,9	43066-7	
		2,7	43068-1	
Ahorn maple		0,9	43070-4	
		2,7	43072-8	
Kirschbaum cherry wood		0,9	43074-2	
		2,7	43076-6	
Eiche rustikal rustic oak		0,9	43078-0	
		2,7	43080-3	

SLP-System 7-17 mm, Edelstahl matt, flexibel / SLP-system 7-17 mm, flexible, 3 parts

SB-Pack inkl. Schrauben / Dübel; VE 20 Stück

self-service-pack with screws / dowels; à 20 pcs.

Größe / dimension	L / l (m)	Art. / ref.	€/Stk. / pcs.
-------------------	-----------	-------------	---------------

151 SLP-Übergangprofil 37 mm, Edelstahl matt, für Laminat / Parkett 7-17 mm, flexibel, 3-teilig, gebohrt

SLP-edge 37 mm, stainless steel matt, for laminate / wooden floors 7-17 mm, flexible, 3 parts, drilled

37 x 1,5 mm	0,9	42900-5	
	2,7	42905-0	

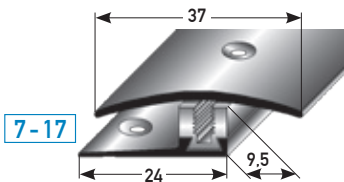

gleichzeitig Höhenausgleich bis 5 mm
height levelling up to 5 mm

Zusätzliche Schrauben siehe Abschnitt 12.
additional screws, see section 12.

152 SLP-Höhenausgleichprofil 40 mm, Edelstahl matt, für Laminat / Parkett 7-17 mm, flexibel, 3-teilig, gebohrt

SLP-height levelling 40 mm, stainless steel matt, for laminate / wooden floors 7-17 mm, flexible, 3 parts, drilled

40 x 1,5 mm	0,9	42910-4	
	2,7	42915-9	

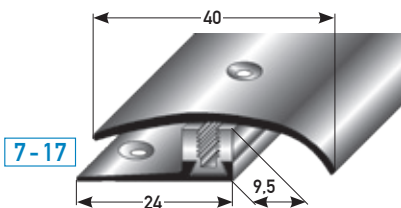

Zusätzliche Schrauben siehe Abschnitt 12.
additional screws, see section 12.

148 SLP-Abschlussprofil 26 mm, Edelstahl matt, für Gesamthöhe 7-9 mm, flexibel, 3-teilig, gebohrt

SLP-end 26 mm, stainless steel matt, for heights 7-9 mm, flexible, 3 parts, drilled

7-9 x 26 x 1,5 mm	0,9	42920-3	
	2,7	42925-8	

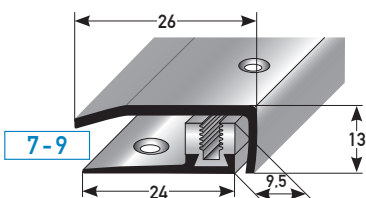

Zusätzliche Schrauben siehe Abschnitt 12.
additional screws, see section 12.

149 SLP-Abschlussprofil 28 mm, Edelstahl matt, für Gesamthöhe 10-13 mm, flexibel, 3-teilig, gebohrt

SLP-end 28 mm, stainless steel matt, for heights 10-13 mm, flexible, 3 parts, drilled

10-13 x 28 x 1,5 mm	0,9	42930-2	
	2,7	42935-7	

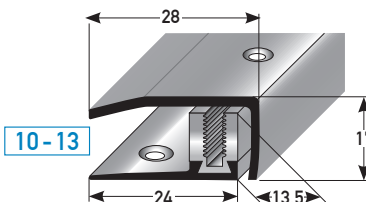

Zusätzliche Schrauben siehe Abschnitt 12.
additional screws, see section 12.

150 SLP-Abschlussprofil 26 mm, Edelstahl matt, für Gesamthöhe 14-17 mm, flexibel, 3-teilig, gebohrt

SLP-end 26 mm, stainless steel matt, for heights 14-17 mm, flexible, 3 parts, drilled

14-17 x 26 x 1,5 mm	0,9	42940-1	
	2,7	42945-6	

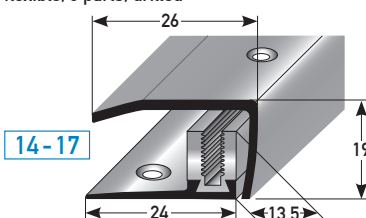

Zusätzlich Schrauben siehe Abschnitt 12.
additional screws, see section 12.



8. Sockelleisten aus Edelstahl und Aluminium

8. skirtings out of stainless steel + aluminium

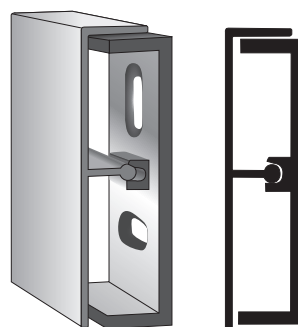
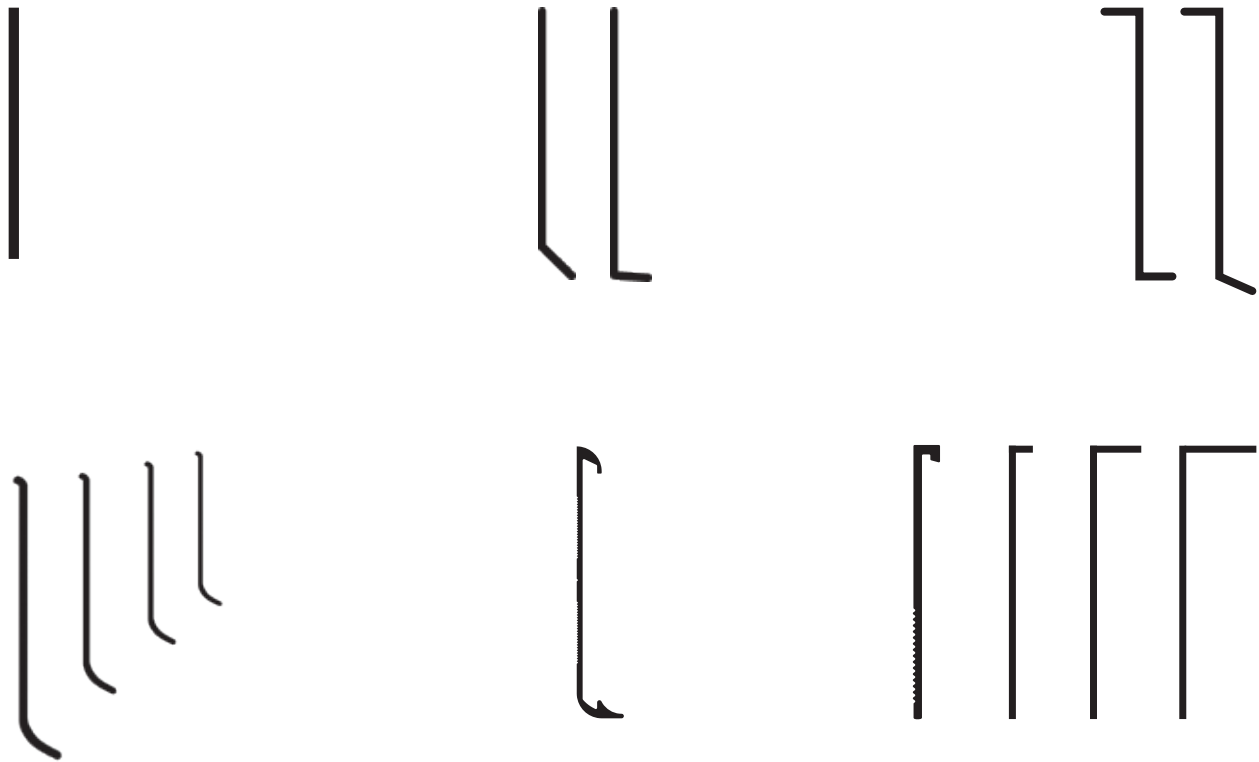

8



Andere Abmaße auf Anfrage
other dimensions on demand

Flach-Sockelleiste aus Edelstahl matt, TYP i-Form

flat skirting out of stainless steel matt, type i-form

Breite / width A (mm)	L / l (m)	B = 1,0 mm Materialstärke / thickness			B = 1,5 mm Materialstärke / thickness		
		Koffernr. case no.	Art. / ref.	€/Stk. / pcs.	Koffernr. case no.	Art. / ref.	€/Stk. / pcs.

413 Flachsockelleiste 1,0/1,5/2,0/3,0 mm, Edelstahl matt

flat skirting, 1,0/1,5/2,0/3,0 mm,
stainless steel matt

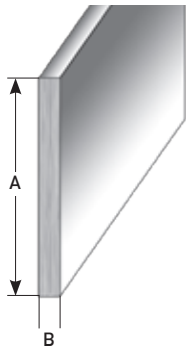

NEU! 30 mm	1,00	548	72648-7	549	72660-9
	2,50		72650-0		72662-3
NEU! 35 mm	1,00	550	72652-4	551	72664-7
	2,50		72654-8		72666-1
40 mm	1,00	442	68350-6	443	68362-9
	2,50		68352-0		68364-3
NEU! 45 mm	1,00	552	72656-2	553	72668-5
	2,50		72658-6		72670-8
50 mm	1,00	285	67420-7	288	67442-9
	2,50		61892-8		61906-2
60 mm	1,00	286	67422-1	289	67444-3
	2,50		61894-2		61908-6
70 mm	1,00	414	67424-5	416	67446-7
	2,50		67426-9		67448-1
80 mm	1,00	287	67428-3	290	67450-4
	2,50		61896-6		61910-9
100 mm	1,00	415	67430-6	291	67452-8
	2,50		67432-0		61912-3

* Bitte Befestigungstyp angeben:

- 01 mittig gebohrt
- 02 seitlich gebohrt
- 03 wechselseitig gebohrt
- 04 ungebohrt
- 05 selbstklebend

Please specify fixing:

- 01 drilled centrally
- 02 drilled laterally
- 03 alternating sides drilled
- 04 undrilled
- 05 self-adhesive

Breite / width A (mm)	L / l (m)	B = 2,0 mm Materialstärke / thickness			B = 3,0 mm Materialstärke / thickness		
		Koffernr. case no.	Art. / ref.	€/Stk. / pcs.	Koffernr. case no.	Art. / ref.	€/Stk. / pcs.

Bohrungen bis 2 mm Stärke
für 3,5 mm Schrauben:
Bohrungen bis 3 mm Stärke
für 4 mm Schrauben

holes up to 2 mm thickness
for 3.5 mm screws;
drilling at 3 mm for 4 mm screws

NEU! 30 mm	1,00	554	72672-2	555	72684-5
	2,50		72674-6		72686-9
NEU! 35 mm	1,00	556	72676-0	557	72688-3
	2,50		72678-4		72690-6
40 mm	1,00	444	68374-2	445	68386-5
	2,50		68376-6		68388-9
NEU! 45 mm	1,00	558	72680-7	559	72692-0
	2,50		72682-1		72694-4
50 mm	1,00	417	67464-1	422	67496-2
	2,50		67466-5		67498-6
60 mm	1,00	418	67468-9	423	67500-6
	2,50		67470-2		67502-0
70 mm	1,00	419	67472-6	424	67504-4
	2,50		67474-0		67506-8
80 mm	1,00	420	67476-4	425	67508-2
	2,50		67478-8		67510-5
100 mm	1,00	421	67480-1	426	67512-9
	2,50		67482-5		67514-3

Anfertigung von passenden
Innen- und Außenecken
siehe Seite 113 – Lieferzeit
nach Vereinbarung

production of matching corners
see page 113 – delivery time
by prior arrangement

Edelstahlschrauben siehe Abschnitt 12
stainless steel screws see section 12

Andere Abmaße auf Anfrage
other dimensions on demand

Abkant-Sockelleiste,
Edelstahl matt, gekantet
auf 94° oder 135°

edged skirting, stainless steel matt,
edged 94° or 135°

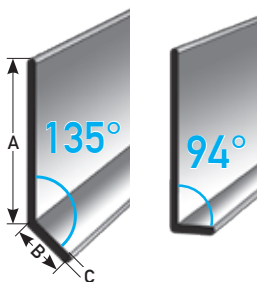

Bitte bei Bestellung die
genaue Gradzahl angeben!
Please specify the exact number
of degrees when ordering!



Abkantung mit Dach, um alte
Sockelleisten zu überdecken
auf Anfrage erhältlich.
edged with a roof to cover old
baseboards, available on request

Abkant-Sockelleiste Edelstahl matt, gekantet, TYP L- & j-Form

edged skirting out of stainless steel matt, type L- + j-form

Bitte bei Bestellung immer Winkel, 94° oder 135°, angeben!
Please specify when ordering the number of degrees of tilt with 94° or 135°!

A x B x C (mm)	L/l (m)	selbstkl./ self-adhesive	€/m	gebohrt/ drilled	€/m	ohne alles/ bare	€/m
473	40 x 10 x 1,0	2,5	69704-6	69718-3		69732-9	
	40 x 15 x 1,0	2,5	69706-0	69720-6		69734-3	
	40 x 10 x 1,5	2,5	69708-4	69722-0		69736-7	
	40 x 15 x 1,5	2,5	69710-7	69724-4		69738-1	
	40 x 15 x 2,0	2,5	69712-1	69726-8		69740-4	
	40 x 15 x 3,0	2,5	69714-5	69728-2		69742-8	
223	50 x 10 x 1,0	2,5	69748-0	69762-6		60320-7	
	50 x 15 x 1,0	2,5	69750-3	69764-0		69778-7	
	50 x 10 x 1,5	2,5	69752-7	69766-4		69780-0	
	50 x 15 x 1,5	2,5	69754-1	69768-8		69782-4	
	50 x 15 x 2,0	2,5	69756-5	69770-1		69784-8	
	50 x 15 x 3,0	2,5	69758-9	69772-5		69786-2	
224	60 x 10 x 1,0	2,5	69792-3	69806-7		69820-3	
	60 x 15 x 1,0	2,5	69794-7	69808-1		61600-9	
	60 x 10 x 1,5	2,5	69796-1	69810-4		69824-1	
	60 x 15 x 1,5	2,5	69798-5	69812-8		69826-5	
	60 x 15 x 2,0	2,5	69800-5	69814-2		69828-9	
	60 x 15 x 3,0	2,5	69802-9	69816-6		69830-2	
225	80 x 10 x 1,0	2,5	69836-4	69850-0		69864-7	
	80 x 15 x 1,0	2,5	69838-8	69852-4		61610-8	
	80 x 10 x 1,5	2,5	69840-1	69854-8		69868-5	
	80 x 15 x 1,5	2,5	69842-5	69856-2		69870-8	
	80 x 15 x 2,0	2,5	69844-9	69858-6		69872-2	
	80 x 15 x 3,0	2,5	69846-3	69860-9		69874-6	
226	100 x 10 x 1,0	2,5	69880-7	69894-4		69908-8	
	100 x 15 x 1,0	2,5	69882-1	69896-8		69910-1	
	100 x 10 x 1,5	2,5	69884-5	69898-2		69912-5	
	100 x 15 x 1,5	2,5	69886-9	69900-2		61620-7	
	100 x 15 x 2,0	2,5	69888-3	69902-6		69916-3	
	100 x 15 x 3,0	2,5	69890-6	69904-0		69918-7	

Anfertigung von passenden Innen- und Außenecken siehe Seite 113 –
Lieferzeit nach Vereinbarung

production of matching corners see page 113 – delivery time by prior arrangement

Andere Abmaße auf Anfrage
other dimensions on demand

Einklebe-Sockelleiste Edelstahl matt, gekantet, TYP r-Form

stainless steel skirting for bonding flooring, edged, matt, type r-form

A x B x C (mm)	L/l (m)	selbstkl. / self-adhesive	€/m	gebohrt / drilled	€/m	ohne alles / bare	€/m
----------------	---------	---------------------------	-----	-------------------	-----	-------------------	-----

Einklebe-Sockelleiste Edelstahl matt, gekantet

stainless steel skirtings for bonding flooring, edged, matt

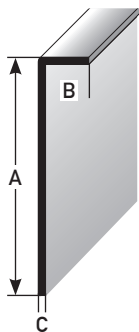

452	40 x 6 x 1,0	2,5	68618-7		68626-2		68634-7
	40 x 11 x 1,0	2,5	68620-0		68628-6		68636-1
453	50 x 6 x 1,0	2,5	68642-2		68650-7		68658-3
	50 x 11 x 1,0	2,5	68644-6		68652-1		68660-6
454	60 x 6 x 1,0	2,5	68666-8		68674-3		68682-8
	60 x 11 x 1,0	2,5	68668-2		68676-7		68684-2
455	80 x 6 x 1,0	2,5	68690-3		68698-9		68706-1
	80 x 11 x 1,0	2,5	68692-7		68700-9		68708-5
456	100 x 6 x 1,5	2,5	68714-6		68722-1		68730-6
	100 x 11 x 1,5	2,5	68716-0		68724-5		68732-0

Anfertigung von passenden Innen- und Außenecken siehe unten / production of matching corners see below

Passende Ecken (30 x 30 mm), feingeschweisst, für alle Sockelleisten: auf Gehrung geschnitten, feingeschweisst, als 90°-Ecke

matching corners (30 x 30 mm) for all skirtings, finely welded, as a 90° corner

Auf Wunsch an Stange gearbeitet
on re cut by miter cut on skirting

Andere Gradzahlen auf Anfrage möglich.

Other degrees possible on request.

Innenecke inside corner	61830-0
Außenecke outside corner	61840-9

Preis pro Ecke / price per corner	
Art. / ref.	€/Stück / pcs.
61830-0	Laufmeterpreis der jeweiligen Sockelleiste = Preis pro Ecke price per meter of the respective skirting = price per corner
61840-9	

Lieferzeit nach Vereinbarung / delivery time by prior arrangement

Beispiel: Außenecke
Aluminium silber

example: outside corner
aluminium silver



Beispiel: Innenecke
Aluminium silber

example: inside corner
aluminium silver



8. SOCKELLEISTEN / 8. SKIRTINGS

Andere Abmaße auf Anfrage
other dimensions on demand

Lieferzeit für Pulver-
beschichtung auf Anfrage
delivery time for powder coating
on request

Aluminium-Flach-Sockelleiste Typ i-Form

aluminium flat skirting type i-form

Selbstklebende Sockelleisten zusätzlich punktwise mit Montagekleber befestigen!
Please fasten self-adhesive skirtings also with dots of installation glue!

Farbe / colour	A x B (mm)	L/l (m)	selbstkl./ self- adhesive	€/m	gebohrt/ drilled	€/m	ohne alles/ bare	€/m
----------------	------------	---------	---------------------------------	-----	---------------------	-----	---------------------	-----

Flach-Sockelleiste, Aluminium, Typ i-Form

flat skirting, aluminium,
type i-form

HÖHE/height 40 mm



457 538 539 silber eloxiert silver anodised	40 x 1,0	2,5	68736-8		68744-3		68752-8	
	40 x 2,0	2,5	68738-2		68746-7		68754-2	
	40 x 3,0	2,5*	68740-5		68748-1		68756-6	
edelstahlfarbig stainless steel coloured	40 x 1,0	2,5*	68760-3		68768-9		68776-4	
	40 x 2,0	2,5*	68762-7		68770-2		68778-8	
	40 x 3,0	2,5*	68764-1		68772-6		68780-1	
Pulvern nach RAL / powder RAL (Preis ab 150 lfm./ price from 150m)	40 x 1,0	2,5	68784-9		68792-4		68800-6	
	40 x 2,0	2,5	68786-3		68794-8		68802-0	
	40 x 3,0	2,5	68788-7		68796-2		68804-4	
Pulvern nach RAL unter 150 lfm. auf Anfrage / powdered (RAL) less than 150 m on request								

HÖHE/height 50 mm

458 540 541 silber eloxiert silver anodised	50 x 1,0	2,5	68808-2		68816-7		68824-2	
	50 x 2,0	2,5	68810-5		68818-1		68826-6	
	50 x 3,0	2,5*	68812-9		68820-4		68828-0	
edelstahlfarbig stainless steel coloured	50 x 1,0	2,5*	68832-7		68840-2		68848-8	
	50 x 2,0	2,5*	68834-1		68842-6		68850-1	
	50 x 3,0	2,5*	68836-5		68844-0		68852-5	
Pulvern nach RAL / powder RAL (Preis ab 150 lfm./ price from 150m)	50 x 1,0	2,5	68856-3		68864-8		68872-3	
	50 x 2,0	2,5	68858-7		68866-2		68874-7	
	50 x 3,0	2,5	68860-0		68868-6		68876-1	
Pulvern nach RAL unter 150 lfm. auf Anfrage / powdered (RAL) less than 150 m on request								

HÖHE/height 60 mm

298 428 299 300 silber eloxiert silver anodised	60 x 1,0	2,5	61918-5		61924-6		61930-7	
	60 x 2,0	2,5	67240-1		67246-3		67252-4	
	60 x 3,0	2,5*	61938-3		61944-4		61950-5	
	60 x 5,0	3,0*	61958-1		61964-2		61970-3	
edelstahlfarbig stainless steel coloured	60 x 1,0	2,5*	61920-8		61926-0		61932-1	
	60 x 2,0	2,5*	67242-5		67248-7		67254-8	
	60 x 3,0	2,5*	61940-6		61946-8		61952-9	
	60 x 5,0	3,0*	61960-4		61966-6		61972-7	
Pulvern nach RAL / powder RAL (Preis ab 150 lfm./ price from 150m)	60 x 1,0	2,5	61922-2		61928-4		61934-5	
	60 x 2,0	2,5	67244-9		67250-0		67256-2	
	60 x 3,0	2,5	61942-0		61948-2		61954-3	
	60 x 5,0	3,0	61962-8		61968-0		61974-1	
Pulvern nach RAL unter 150 lfm. auf Anfrage / powdered (RAL) less than 150m on request								

* inklusive 40 mm
Klemmstelle an einer
Seite vom Eloxieren
including 40 mm clamping
point on one side by anodizing

3,0 m-Ware ist nur per Spedition lieferbar (gesonderte Transportkosten)

3.0 m profiles are only available per forwarding agency (separate transport costs)

Anfertigung von passenden Innen- und Außenecken siehe Seite 113 – Lieferzeit nach Vereinbarung

production of matching corners see page 113 – delivery time by prior arrangement

Andere Abmaße auf Anfrage
other dimensions on demand

Lieferzeit für Pulver-
beschichtung auf Anfrage
delivery time for powder coating
on request

Aluminium-Flach-Sockelleiste Typ i-Form

aluminium flat skirting type i-form

Selbstklebende Sockelleisten zusätzlich punktweise mit Montagekleber befestigen!
Please fasten self-adhesive skirtings also with dots of installation glue!

Farbe / colour	A x B (mm)	L/l (m)	selbstkl. / self-adhesive	€/m	gebohrt / drilled	€/m	ohne alles / bare	€/m
----------------	------------	---------	---------------------------	-----	-------------------	-----	-------------------	-----

Flach-Sockelleiste, Aluminium, Typ i-Form

flat skirting, aluminium, type i-form

HÖHE / height 80 mm



542 543 544 silber eloxiert silver anodised	80 x 1,0	2,5	68880-8		68888-4		68896-9	
	80 x 2,0	2,5	68882-2		68890-7		68898-3	
	80 x 3,0	2,5*	68884-6		68892-1		68900-3	
edelstahlfarbig stainless steel coloured	80 x 1,0	2,5*	68904-1		68912-6		68920-1	
	80 x 2,0	2,5*	68906-5		68914-0		68922-5	
	80 x 3,0	2,5*	68908-9		68916-4		68924-9	
Pulvern nach RAL / powder RAL (Preis ab 150 lfm. / price from 150m)	80 x 1,0	2,5	68928-7		68936-2		68944-7	
	80 x 2,0	2,5	68930-0		68938-6		68946-1	
	80 x 3,0	2,5	68932-4		68940-9		68948-5	
Pulvern nach RAL unter 150 lfm. auf Anfrage / powdered (RAL) less than 150 m on request								

HÖHE / height 100 mm

545 546 547 silber eloxiert silver anodised	100 x 1,0	2,5	68952-2		68960-7		68968-3	
	100 x 2,0	2,5	68954-6		68962-1		68970-6	
	100 x 3,0	2,5*	68956-0		68964-5		68972-0	
edelstahlfarbig stainless steel coloured	100 x 1,0	2,5*	68976-8		68984-3		68992-8	
	100 x 2,0	2,5*	68978-2		68986-7		68994-2	
	100 x 3,0	2,5*	68980-5		68988-1		68996-6	
Pulvern nach RAL / powder RAL (Preis ab 150 lfm. / price from 150 m)	100 x 1,0	2,5	69000-9		69008-5		69016-0	
	100 x 2,0	2,5	69002-3		69010-8		69018-4	
	100 x 3,0	2,5	69004-7		69012-2		69020-7	
Pulvern nach RAL unter 150 lfm. auf Anfrage / powdered (RAL) less than 150 m on request								

* inklusive 40 mm
Klemmstelle an einer
Seite vom Eloxieren
including 40 mm clamping
point on one side by anodizing

Anfertigung von passenden Innen- und Außenecken siehe Seite 113 – Lieferzeit nach Vereinbarung
production of matching corners see page 113 – delivery time by prior arrangement

Sockelblech

skirting metal sheet

Material / Befestigung material / fixing	A x B (mm)	L / l (m)	Art. / ref.	€/Stk. / €/pcs.
---	------------	-----------	-------------	-----------------

Sockelblech 200 x 1 mm

skirting metal sheet 200 x 1 mm

Aluminium, blank, gelocht aluminium bare, drilled	200 x 1	1,0	22060-2	
--	---------	-----	---------	--

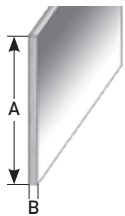

Andere Abmaße auf Anfrage
other dimensions on request



8. SOCKELLEISTEN / 8. SKIRTINGS

Andere Abmaße auf Anfrage
other dimensions on demand

Lieferzeit für Pulver-
beschichtung auf Anfrage
delivery time for powder coating
on request

Abkant-Sockelleiste Aluminium, TYP L- & j-Form

edged skirting out of aluminium, L- + j-form

Bitte bei Bestellung immer Winkel, 94° oder 135°, angeben!
Please specify when ordering the number of degrees of tilt with 94° or 135°!

Farbe / colour	A x B x C (mm)	L/l (m)	selbstkl. / self-adhesive	€/m	gebohrt / drilled	€/m	ohne alles / bare	€/m
----------------	----------------	---------	---------------------------	-----	-------------------	-----	-------------------	-----

Abkant-Sockelleiste, Aluminium, gekantet auf 94° oder 135°

edged skirting, aluminium,
edged 94° or 135°

461

silber eloxiert silver anodised	40 x 10 x 1,0	2,5	69024-5		69034-4		69044-3	
	40 x 20 x 1,0	2,5	69026-9		69036-8		69046-7	
	40 x 10 x 2,0	2,5	69028-3		69038-2		69048-1	
	40 x 20 x 2,0	2,5	69030-6		69040-5		69050-4	

Bitte bei Bestellung die
genaue Gradzahl angeben!

Please specify the exact number
of degrees when ordering!

HÖHE / height 40 mm

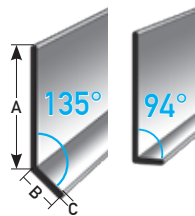

edelstahlfarbig stainless steel coloured	40 x 10 x 1,0	2,5*	69054-2		69064-1		69074-0	
	40 x 20 x 1,0	2,5*	69056-6		69066-5		69076-4	
	40 x 10 x 2,0	2,5*	69058-0		69068-9		69078-8	
	40 x 20 x 2,0	2,5*	69060-3		69070-2		69080-1	

Pulvern nach RAL/ powder RAL (Preis ab 150 lfm. / price from 150 m)	40 x 10 x 1,0	2,5	69084-9		69094-8		69104-4	
	40 x 20 x 1,0	2,5	69086-3		69096-2		69106-8	
	40 x 10 x 2,0	2,5	69088-7		69098-6		69108-2	
	40 x 20 x 2,0	2,5	69090-0		69100-6		69110-5	
Pulvern nach RAL unter 150 lfm. auf Anfrage / powdered (RAL) less than 150 m on request								

HÖHE / height 50 mm

292

silber eloxiert silver anodised	50 x 10 x 1,0	2,5	69662-9		69676-6		69690-2	
	50 x 20 x 1,0	2,5	65000-3		65006-5		65012-6	
	50 x 10 x 2,0	2,5	69664-3		69678-0		69692-6	
	50 x 20 x 2,0	2,5	65020-1		65026-3		65032-4	

293

edelstahlfarbig stainless steel coloured	50 x 10 x 1,0	2,5*	69666-7		69680-3		69694-0	
	50 x 20 x 1,0	2,5*	65002-7		65008-9		65014-0	
	50 x 10 x 2,0	2,5*	69668-1		69682-7		69696-4	
	50 x 20 x 2,0	2,5*	65022-5		65028-7		65034-8	

Pulvern nach RAL/ powder RAL (Preis ab 150 lfm. / price from 150 m)	50 x 10 x 1,0	2,5	69670-4		69684-1		69698-8	
	50 x 20 x 1,0	2,5	65004-1		65010-2		65016-4	
	50 x 10 x 2,0	2,5	69672-8		69686-5		69700-8	
	50 x 20 x 2,0	2,5	65024-9		65030-0		65036-2	
Pulvern nach RAL unter 150 lfm. auf Anfrage / powdered (RAL) less than 150 m on request								

HÖHE / height 60 mm

296

silber eloxiert silver anodised	60 x 10 x 1,0	2,5	65080-5		65086-7		65092-8	
	60 x 20 x 1,0	2,5	65040-9		65046-1		65052-2	
	60 x 10 x 2,0	2,5	65100-0		65106-2		65112-3	
	60 x 20 x 2,0	2,5	65060-7		65066-9		65072-0	

294

297

295

* inklusive 40 mm
Klemmstelle an einer
Seite vom Eloxieren
including 40 mm clamping
point on one side by anodizing

edelstahlfarbig stainless steel coloured	60 x 10 x 1,0	2,5*	65082-9		65088-1		65094-2	
	60 x 20 x 1,0	2,5*	65042-3		65048-5		65054-6	
	60 x 10 x 2,0	2,5*	65102-4		65108-6		65114-7	
	60 x 20 x 2,0	2,5*	65062-1		65068-3		65074-4	

Anfertigung von passenden
Innen- und Außenecken
siehe Seite 113 – Lieferzeit
nach Vereinbarung
production of matching corners
see page 113 – delivery time by
prior arrangement

Pulvern nach RAL/ powder RAL (Preis ab 150 lfm. / price from 150 m)	60 x 10 x 1,0	2,5	65084-3		65090-4		65096-6	
	60 x 20 x 1,0	2,5	65044-7		65050-8		65056-0	
	60 x 10 x 2,0	2,5	65104-8		65110-9		65116-1	
	60 x 20 x 2,0	2,5	65064-5		65070-6		65076-8	
Pulvern nach RAL unter 150 lfm. auf Anfrage / powdered (RAL) less than 150 m on request								

Andere Abmaße auf Anfrage
other dimensions on demand

Lieferzeit für Pulverbeschichtung auf Anfrage
delivery time for powder coating on request

Abkant-Sockelleiste Aluminium, TYP L- & j-Form

edged skirting out of aluminium, L- + j-form

Bitte bei Bestellung immer Winkel, 94° oder 135°, angeben!
Please specify when ordering the number of degrees of tilt with 94° or 135°!

Farbe / colour	A x B x C (mm)	L/l (m)	selbstkl./ self-adhesive	€/m	gebohrt/ drilled	€/m	ohne alles/ bare	€/m
----------------	----------------	---------	--------------------------	-----	------------------	-----	------------------	-----

Abkant-Sockelleiste, Aluminium, gekantet auf 94° oder 135°

edged skirting, aluminium, edged 94° or 135°

462

silber eloxiert silver anodised	80 x 10 x 1,0	2,5	69114-3		69124-2		69134-1		
	80 x 20 x 1,0	2,5	69116-7		69126-6		69136-5		
	80 x 10 x 2,0	2,5	69118-1		69128-0		69138-9		
	80 x 20 x 2,0	2,5	69120-4		69130-3		69140-2		
edelstahlfarbig stainless steel coloured	80 x 10 x 1,0	2,5*	69144-0		69154-9		69164-8		
	80 x 20 x 1,0	2,5*	69146-4		69156-3		69166-2		
	80 x 10 x 2,0	2,5*	69148-8		69158-7		69168-6		
	80 x 20 x 2,0	2,5*	69150-1		69160-0		69170-9		
Pulvern nach RAL/ powder RAL (Preis ab 150 lfm. / price from 150 m)	80 x 10 x 1,0	2,5	69174-7		69184-6		69194-5		
	80 x 20 x 1,0	2,5	69176-1		69186-0		69196-9		
	80 x 10 x 2,0	2,5	69178-5		69188-4		69198-3		
	80 x 20 x 2,0	2,5	69180-8		69190-7		69200-3		
	Pulvern nach RAL unter 150 lfm. auf Anfrage / powdered (RAL) less than 150 m on request								

Bitte bei Bestellung die genaue Gradzahl angeben!

Please specify the exact number of degrees when ordering!

HÖHE / height 80 mm

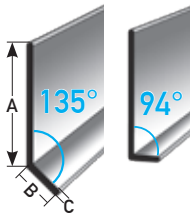

HÖHE / height 100 mm

463

silber eloxiert silver anodised	100 x 10 x 1,0	2,5	69204-1		69214-0		69224-9	
	100 x 20 x 1,0	2,5	69206-5		69216-4		69226-3	
	100 x 10 x 2,0	2,5	69208-9		69218-8		69228-7	
	100 x 20 x 2,0	2,5	69210-2		69220-1		69230-0	
edelstahlfarbig stainless steel coloured	100 x 10 x 1,0	2,5*	69234-8		69244-7		69254-6	
	100 x 20 x 1,0	2,5*	69236-2		69246-1		69256-0	
	100 x 10 x 2,0	2,5*	69238-6		69248-5		69258-4	
	100 x 20 x 2,0	2,5*	69240-9		69250-8		69260-7	
Pulvern nach RAL/ powder RAL (Preis ab 150 lfm. / price from 150 m)	100 x 10 x 1,0	2,5	69264-5		69274-4		69284-3	
	100 x 20 x 1,0	2,5	69266-9		69276-8		69286-7	
	100 x 10 x 2,0	2,5	69268-3		69278-2		69288-1	
	100 x 20 x 2,0	2,5	69270-6		69280-5		69290-4	
Pulvern nach RAL unter 150 lfm. auf Anfrage / powdered (RAL) less than 150 m on request								

* inklusive 40 mm Klemmstelle an einer Seite vom Eloxieren including 40 mm clamping point on one side by anodizing

Abkantung mit Dach, um alte Sockelleisten zu überdecken auf Anfrage erhältlich.
edged with a roof to cover old baseboards, available on request

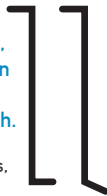

Anfertigung von passenden Innen- und Außenecken siehe Seite 113 – Lieferzeit nach Vereinbarung
production of matching corners see page 113 – delivery time by prior arrangement

Pulverbeschichtet? Selbstklebend? Sonderlängen? Auf Anfrage erhältlich.
Powdered (RAL)? Self-adhesive? Special length cuts? Available on demand.

Aluminium-Einklebe-Sockelleiste für 3 mm-Beläge

aluminium skirting for 3 mm flooring

Farbe / colour	L/l (m)	Art. / ref.	€/m
----------------	---------	-------------	-----

310 DESIGN-Einklebe-Sockelleiste 60 x 10 x 3,2 mm für Designbeläge bis 3 mm, Aluminium eloxiert, gebohrt

DESIGN skirting 60 x 10 x 3,2 mm for bonding floor to 3 mm, aluminium anodized, drilled

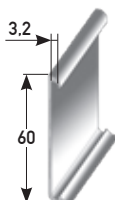

silber eloxiert silver anodised	2,5	44524-1	
edelstahlfarbig / AL-INOX stainless steel coloured	2,5	44532-6	

Lieferzeit für Pulverbeschichtung auf Anfrage
 delivery time for powder coating on request

Aluminium-Sockelleiste Typ L40 - L100, stranggepresst							
aluminium skirting type L40 - L100, extruded							
Selbstklebende Sockelleisten zusätzlich punktweise mit Montagekleber befestigen! Please fasten self-adhesive skirtings also with dots of installation glue!							
Farbe / colour	L / l (m)	selbstkl. / self-adhesive	€/m	gebohrt / drilled	€/m	ohne alles / bare	€/m

156 Aluminium-Sockelleiste 40 x 10 x 1,4 mm, Typ L40, stranggepresst

aluminium, skirting
 40 x 10 x 1,4 mm,
 type L40, extruded

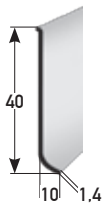

silber eloxiert / silver anodized	2,5	44000-0		44004-8		44008-6	
edelstahlfarbig / Feinschliff stainless steel coloured / fine-honed	2,5	44036-9		44040-6		44044-4	
Pulvern nach RAL / powder RAL Preis ab 150 lfm. / price from 150m	2,5	44018-5		44022-2		44026-0	
Pulvern nach RAL unter 150 lfm. auf Anfrage powdered (RAL) less than 150 m on request							

157 Aluminium-Sockelleiste 50 x 10 x 1,4 mm, Typ L50, stranggepresst

aluminium, skirting
 50 x 10 x 1,4 mm
 type L50, extruded

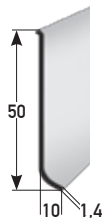

silber eloxiert / silver anodized	2,5	44056-7		44060-4		44064-2	
edelstahlfarbig / Feinschliff stainless steel coloured / fine-honed	2,5	44092-5		44096-3		44100-7	
Pulvern nach RAL / powder RAL Preis ab 150 lfm. / price from 150m	2,5	44074-1		44078-9		44082-6	
Pulvern nach RAL unter 150 lfm. auf Anfrage powdered (RAL) less than 150 m on request							

158 Aluminium-Sockelleiste 60 x 10 x 1,5 mm, Typ L60, stranggepresst

aluminium, skirting
 60 x 10 x 1,5 mm
 type L60, extruded

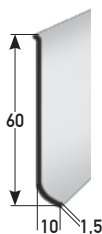

silber eloxiert silver anodized	2,5	44112-0		44116-8		44120-5	
edelstahlfarbig / Feinschliff stainless steel coloured / fine-honed	2,5	44148-9		44152-6		44156-4	
Pulvern nach RAL / powder RAL Preis ab 150 lfm. / price from 150 m	2,5	44130-4		44134-2		44138-0	
Pulvern nach RAL unter 150 lfm. auf Anfrage powdered (RAL) less than 150 m on request							

159 Aluminium-Sockelleiste 80 x 10 x 1,5 mm, Typ L80, stranggepresst

aluminium, skirting
 80 x 10 x 1,5 mm
 type L80, extruded

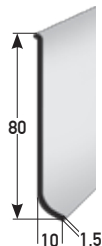

silber eloxiert silver anodized	2,5	44168-7		44172-4		44176-2	
edelstahlfarbig / Feinschliff stainless steel coloured / fine-honed	2,5	44204-2		44208-0		44212-7	
Pulvern nach RAL / powder RAL Preis ab 150 lfm. / price from 150 m	2,5	44186-1		44190-8		44194-6	
Pulvern nach RAL unter 150 lfm. auf Anfrage powdered (RAL) less than 150 m on request							

569 Aluminium-Sockelleiste 100 x 10 x 1,7 mm, Typ L100, stranggepresst

aluminium, skirting
 100 x 10 x 1,7 mm
 type L100, extruded



silber eloxiert silver anodized	2,5	72526-8		72532-9		72538-1	
edelstahlfarbig / Feinschliff stainless steel coloured / fine-honed	2,5	72528-2		72534-3		72540-4	
Pulvern nach RAL / powder RAL Preis ab 150 lfm. / price from 150 m	2,5	72530-5		72536-7		72542-8	
Pulvern nach RAL unter 150 lfm. auf Anfrage powdered (RAL) less than 150 m on request							

Druckguss-Zubehör für Aluminium-Sockelleiste Typen L40 - L100

diecast accessories for aluminium skirting types L40 - L100

Farbe / colour	Art. / ref.	€/Stk. / pcs.	Art. / ref.	€/Stk. / pcs.	Art. / ref.	€/Stk. / pcs.	Art. / ref.	€/Stk. / pcs.
----------------	-------------	---------------	-------------	---------------	-------------	---------------	-------------	---------------

570 Aussenecke für L-Sockelleisten Druckguss

outside corner for L-skirtings, diecast



	L40	L60	L80	L100
silber eloxiert silver anodized	72372-1	72392-9	72412-4	72432-2
Pulvern nach RAL powder RAL	72374-5	72394-3	72414-8	72434-6

571 Innenecke für L-Sockelleisten Druckguss

inside corner for L-skirtings, diecast



	L40	L60	L80	L100
silber eloxiert silver anodized	72376-9	72396-7	72416-2	72436-0
Pulvern nach RAL powder RAL	72378-3	72398-1	72418-6	72438-4

572 Verbinder für L-Sockelleisten Druckguss

connecting piece for L-skirtings, diecast



	L40	L60	L80	L100
silber eloxiert silver anodized	72380-6	72400-1	72420-9	72440-7
Pulvern nach RAL powder RAL	72382-0	72402-5	72422-3	72442-1

573 Endstück LINKS für L-Sockelleisten Druckguss

left end cap for L-skirtings, diecast



	L40	L60	L80	L100
silber eloxiert silver anodized	72384-4	72404-9	72424-7	72444-5
Pulvern nach RAL powder RAL	72386-8	72406-3	72426-1	72446-9

574 Endstück RECHTS für L-Sockelleisten Druckguss

right end cap for L-skirtings, diecast



	L40	L60	L80	L100
silber eloxiert silver anodized	72388-2	72408-7	72428-5	72448-3
Pulvern nach RAL powder RAL	72390-5	72410-0	72430-8	72450-6

Pulverbeschichtung erfolgt nur im Zusammenhang mit pulverbeschichteten Sockelleisten!

Lieferzeit auf Anfrage. Powder coating only when ordering powder coated skirtings! Delivery time on request.

Zubehör für Aluminium-Sockelleiste Typen L40 - L100; VE à 10 Stück

accessories for aluminium skirtings types L40 - L100; professional packing à 10 pcs.

Farbe / colour	Art. / ref.	€/Stk. / pcs.	Art. / ref.	€/Stk. / pcs.	Art. / ref.	€/Stk. / pcs.	Art. / ref.	€/Stk. / pcs.	Art. / ref.	€/Stk. / pcs.
----------------	-------------	---------------	-------------	---------------	-------------	---------------	-------------	---------------	-------------	---------------

160 Aussenecke für L-Sockelleisten, fein geschweißt

outside corner, finely welded

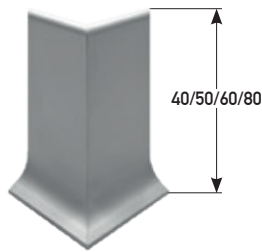

	L40	L50	L60	L80	NEU! L100
silber eloxiert silver anodized	44232-5	44294-3	44356-8	44418-3	72454-4
edelstahlfarb./Feinschliff stainl. steel col. f.-honed	44228-8	44290-5	44352-0	44414-5	72456-8
Pulvern nach RAL powder RAL	44230-1	44292-9	44354-4	44416-9	72458-2

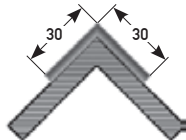

Aufschlag für selbstklebende Ausführung für eine Seite

44222-6

(für 2. Seite Montagekleber verwenden)
extra for self-adhesive version for one side only
(use builders adhesive for 2nd side)

161 Innenecke für L-Sockelleisten, fein geschweißt

inside corner, finely welded

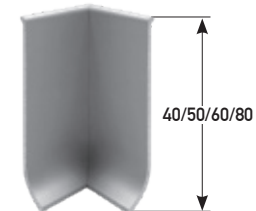

	L40	L50	L60	L80	NEU! L100
silber eloxiert silver anodized	44238-7	44300-1	44362-9	44424-4	72460-5
edelstahlfarb./Feinschliff stainl. steel col. f.-honed	44234-9	44296-7	44358-2	44420-6	72462-9
Pulvern nach RAL powder RAL	44236-3	44298-1	44360-5	44422-0	72464-3

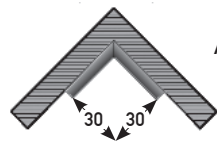

Aufschlag für selbstklebende Ausführung für eine Seite

44222-6

(für 2. Seite Montagekleber verwenden)
extra for self-adhesive version for one side only
(use builders adhesive for 2nd side)

162 Treppenecke hinten, Sockelleiste + 20 mm Auflagemaß, für L-Sockelleisten, fein geschweißt

stair corner rear, skirting + 20 mm flange, finely welded

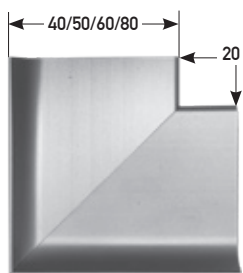

	L40	L50	L60	L80	NEU! L100
silber eloxiert silver anodized	44244-8	44306-3	44368-1	44430-5	72466-7
edelstahlfarb./Feinschliff stainl. steel col. f.-honed	44240-0	44302-5	44364-3	44426-8	72468-1
Pulvern nach RAL powder RAL	44242-4	44304-9	44366-7	44428-2	72470-4

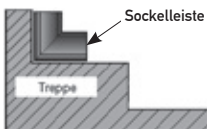

Aufschlag für selbstklebende Ausführung für eine Seite

44222-6

(für 2. Seite Montagekleber verwenden)
extra for self-adhesive version for one side only
(use builders adhesive for 2nd side)

163 Treppenecke vorn, 20 x 20 mm Auflagemaß für L-Sockelleisten, fein geschweißt

stair cornerfront, 20 x 20 mm flange, finely welded

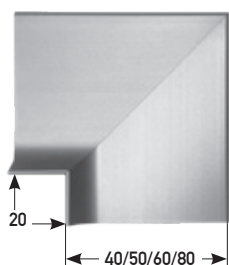

	L40	L50	L60	L80	NEU! L100
silber eloxiert silver anodized	44250-9	44312-4	44374-2	44436-7	72472-8
edelstahlfarb./Feinschliff stainl. steel col. f.-honed	44246-2	44308-7	44370-4	44432-9	72474-2
Pulvern nach RAL powder RAL	44248-6	44310-0	44372-8	44434-3	72476-6

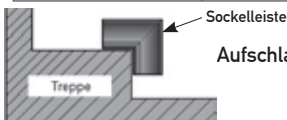

Aufschlag für selbstklebende Ausführung für eine Seite

44222-6

(für 2. Seite Montagekleber verwenden)
extra for self-adhesive version for one side only
(use builders adhesive for 2nd side)

Pulverbeschichtung erfolgt nur im Zusammenhang mit pulverbeschichteten Sockelleisten! Lieferzeit auf Anfrage.
Powder coating only when ordering powder coated skirtings! Delivery time on request.



Andere Abmaße auf Anfrage
other dimensions and colours
on demand

464 Einklebe-Sockelleiste Aluminium silber eloxiert, gekantet

aluminium skirting for bonding flooring, edged, silver anodized

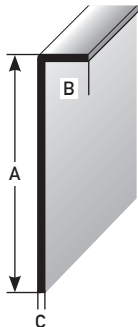

Einklebe-Sockelleiste Aluminium silber eloxiert, gekantet, TYP r-Form							
aluminium skirtings for bonding flooring, edged, type r-form							
A x B x C mm	L / l (m)	selbstkl. / selfadhesive	€/m	gebohrt / drilled	€/m	ohne alles / bare	€/m
40 x 4 x 1,0	2,5	69294-2		69302-4		69310-9	
40 x 6 x 1,0	2,5	69296-6		69304-8		69312-3	
40 x 11 x 1,0	2,5	69298-0		69306-2		69314-7	
50 x 4 x 1,0	2,5	69318-5		69326-0		69334-5	
50 x 6 x 1,0	2,5	69320-8		69328-4		69336-9	
50 x 11 x 1,0	2,5	69322-2		69330-7		69338-3	
60 x 4 x 1,0	2,5	69342-0		69350-5		69358-1	
60 x 6 x 1,0	2,5	69344-4		69352-9		69360-4	
60 x 11 x 1,0	2,5	69346-8		69354-3		69362-8	
80 x 4 x 1,0	2,5	69366-6		69374-1		69382-6	
80 x 6 x 1,0	2,5	69368-0		69376-5		69384-0	
80 x 11 x 1,0	2,5	69370-3		69378-9		69386-4	
100 x 4 x 1,5	2,5	69390-1		69398-7		69406-9	
100 x 6 x 1,5	2,5	69392-5		69400-7		69408-3	
100 x 11 x 1,5	2,5	69394-9		69402-1		69410-6	

Lieferzeit für Pulverbeschichtung auf Anfrage
delivery time for powder coating on request

518 Einklebe-Sockelleiste 45xh=2,5 mm, Aluminium, stranggepresst, mit Fliesenstanzung

skirting 45 x h=2,5 mm for bonding flooring, aluminium, extruded, with triangular punching

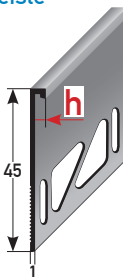

Einklebe-Sockelleisten Aluminium, stranggepresst							
aluminium skirtings for bonding flooring, extruded							
Farbe / colour	L / l (m)	selbstkl. / self-adhesive	€/m	gebohrt / drilled	€/m	ohne alles / bare	€/m
Aluminium pressblank aluminium mill-finish	2,7	-	-	-	-	72250-2	

380 Einklebe-Sockelleiste 60 x 3 mm, Aluminium, stranggepresst

skirting 45 x 2,5 mm for bonding flooring, aluminium, extruded, with triangular punching

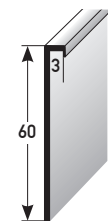

silber eloxiert silver anodized	2,5	66494-9		66496-3		66498-7	
edelstahlfarbig stainless steel coloured	2,5	66500-7		66502-1		66504-5	
Pulvern nach RAL / powder RAL (Preis ab 150 lfm. / price from 150 m)	2,5	66506-9		66508-3		66510-6	
Pulvern nach RAL unter 150 lfm. auf Anfrage / powdered (RAL) less than 150 m on request							

381 Einklebe-Sockelleiste 60 x 5 mm, Aluminium, stranggepresst

skirting 60 x 5 mm for bonding flooring, aluminium, extruded

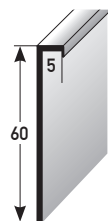

silber eloxiert silver anodized	2,5	66514-4		66516-8		66518-2	
edelstahlfarbig stainless steel coloured	2,5	66520-5		66522-9		66524-3	
Pulvern nach RAL / powder RAL (Preis ab 150 lfm. / price from 150 m)	2,5	66526-7		66528-1		66530-4	
Pulvern nach RAL unter 150 lfm. auf Anfrage / powdered (RAL) less than 150 m on request							

382 Einklebe-Sockelleiste 60 x 11 mm, Aluminium, stranggepresst

skirting 60 x 11 mm for bonding flooring, aluminium, extruded

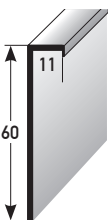

silber eloxiert silver anodized	2,5	66534-2		66536-6		66538-0	
edelstahlfarbig stainless steel coloured	2,5	66540-3		66542-7		66544-1	
Pulvern nach RAL / powder RAL (Preis ab 150 lfm. / price from 150 m)	2,5	66546-5		66548-9		66550-2	
Pulvern nach RAL unter 150 lfm. auf Anfrage / powdered (RAL) less than 150 m on request							

Anfertigung von passenden Innen- und Außenecken siehe Seite 113 – Lieferzeit nach Vereinbarung
production of matching corners see page 113 – delivery time by prior arrangement

Lieferzeit für Pulverbeschichtung auf Anfrage
 delivery time for powder coating on request

CONTEGO-Sockelleiste aus Aluminium, VE = 5 Stück

CONTEGO skirting out of aluminium, unit = 5 pcs.

Farbe / colour	A x B mm	L / l (m)	Art. / ref.	€/m
----------------	----------	-----------	-------------	-----

465 CONTEGO-Sockelleiste, Aluminium, ohne Befestigungszubehör

CONTEGO skirting aluminum, without fixing items



silber eloxiert silver anodized	40 x 11	2,5	69416-8	
	60 x 11	2,5	69418-2	
	60 x 15	2,5	69420-5	
	100 x 11	2,5	69422-9	

Pulvern nach RAL / powder RAL (Preis ab 150 lfm. / price from 150m)	40 x 11	2,5	69436-6	
	60 x 11	2,5	69438-0	
	60 x 15	2,5	69440-3	
	100 x 11	2,5	69442-7	
Pulvern nach RAL unter 150 lfm. auf Anfrage powdered (RAL) less than 150 m on request				

Dieses Profil kann mit Montagekleber **geklebt**, mit Befestigungsclips (siehe Profilnr. 466) **geclipst**, oder auf Anfrage auch **gebohrt** werden zur Befestigung mit Schrauben und Dübel.

This profile can be glued with builders adhesive, clipped with fixing clips (see profile no. 466), or be drilled on request for fixing with screws and dowels.

Auf Anfrage gebohrt erhältlich
 drilled on request

Zubehör für CONTEGO-Sockelleiste

accessories for CONTEGO skirting

466 Befestigungsclip inkl. Schrauben und Dübel für Contego-Sockelleiste

fixing clip with screws and dowels for CONTEGO skirting

Für eine Contego-Sockelleiste à 2,5 m empfehlen wir 6 Befestigungsclips.
 For a Contego skirting of 2.5 m we recommend 6 fixing clips.



Abpackung / unit	Art. / ref.	€
à 1 Stk. / pcs.	69446-5	
Kart. / box à 100 Stk. / pcs.	69447-2	

467 Abdichtlippe für Contego-Sockelleiste, Silikon metallfarben

rubber lip for CONTEGO skirting, silicone metallic coloured

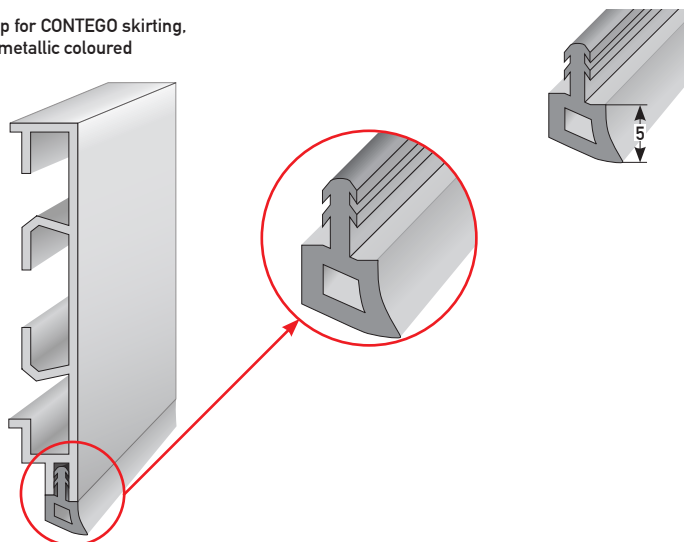

L / l (m)	Art. / ref.	€
Rolle / roll à 20 m	69450-2	

Für Zuschnitte erheben wir einen Arbeitsaufschlag von 15%.
 For cuttings we charge a labor surcharge of 15%.

Lieferzeit für Pulverbeschichtung auf Anfrage
delivery time for powder coating on request

Zubehör für CONTEGO-Sockelleiste				
accessories for CONTEGO skirting				
Farbe / colour	VE/unit	für Größe / for size A x B mm	Art./ref.	€/Stk./pcs.

468 Innenecke für CONTEGO-Sockelleiste, Aluminiumguss

inside corner for CONTEGO skirting, aluminium casting



silberfarbig silver coloured	10 Stck./pcs.	40 x 11	69456-4	
		60 x 11	69458-8	
		60 x 15	69460-1	
		100 x 11	69462-5	
nach RAL to RAL	10 Stck./pcs.	40 x 11	69476-2	
		60 x 11	69478-6	
		60 x 15	69480-9	
		100 x 11	69482-3	
Nur im Zusammenhang mit pulverbeschichteten Sockelleisten möglich! Only possible when ordering coated skirtings!				

469 Außenecke für CONTEGO-Sockelleiste, Aluminiumguss

outside corner for CONTEGO skirting, aluminium casting

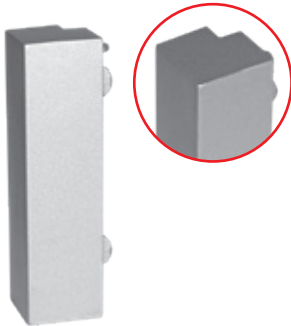

silberfarbig silver coloured	10 Stck./pcs.	40 x 11	69488-5	
		60 x 11	69490-8	
		60 x 15	69492-2	
		100 x 11	69494-6	
nach RAL to RAL	10 Stck./pcs.	40 x 11	69508-0	
		60 x 11	69510-3	
		60 x 15	69512-7	
		100 x 11	69514-1	
Nur im Zusammenhang mit pulverbeschichteten Sockelleisten möglich! Only possible when ordering coated skirtings!				

470 Verbinder für CONTEGO-Sockelleiste, Aluminiumguss

connecting piece for CONTEGO skirting, aluminium casting

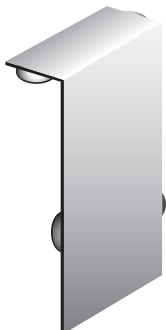

silberfarbig silver coloured	10 Stck./pcs.	40 x 11	69520-2	
		60 x 11	69522-6	
		60 x 15	69524-0	
		100 x 11	69526-4	
nach RAL to RAL	10 Stck./pcs.	40 x 11	69540-0	
		60 x 11	69542-4	
		60 x 15	69544-8	
		100 x 11	69546-2	
Nur im Zusammenhang mit pulverbeschichteten Sockelleisten möglich! Only possible when ordering coated skirtings!				



Lieferzeit für Pulverbeschichtung auf Anfrage
 delivery time for powder coating on request

Zubehör für CONTEGO-Sockelleiste

accessories for CONTEGO skirting

Farbe / colour	VE/unit	für Größe / for size A x B mm	Art./ref.	€/Stk./pcs.
----------------	---------	-------------------------------	-----------	-------------

471 Endstück LINKS für CONTEGO-Sockelleiste, Aluminiumguss

left end cap for CONTEGO skirting, aluminium casting



silberfarbig silver coloured	10 Stck./pcs.	40 x 11	69552-3	
		60 x 11	69554-7	
		60 x 15	69556-1	
		100 x 11	69558-5	

nach RAL to RAL	10 Stck./pcs.	40 x 11	69572-1	
		60 x 11	69574-5	
		60 x 15	69576-9	
		100 x 11	69578-3	

Nur im Zusammenhang mit pulverbeschichteten Sockelleisten möglich!
 Only possible when ordering coated skirtings!

472 Endstück RECHTS für CONTEGO-Sockelleiste, Aluminiumguss

right end cap for CONTEGO skirting, aluminium casting



silberfarbig silver coloured	10 Stck./pcs.	40 x 11	69924-8	
		60 x 11	69926-2	
		60 x 15	69928-6	
		100 x 11	69930-9	

nach RAL to RAL	10 Stck./pcs.	40 x 11	69944-6	
		60 x 11	69946-0	
		60 x 15	69948-4	
		100 x 11	69950-7	

Nur im Zusammenhang mit pulverbeschichteten Sockelleisten möglich!
 Only possible when ordering coated skirtings!

Beispiel: Contego-Sockelleiste mit Zubehör, (siehe Seite 122 - 124)
 example: Contego-skirtings with accessories (see page 122 - 124)



Beispiel: Aluminium-Einklebesockelleiste für Designbeläge (siehe Seite 117)
 example: aluminium design skirting for bonding design floor (see page 117)



Klick-Sockelleiste aus Aluminium

aluminium click skirtings

Farbe / colour	L / l (m)	Art. / ref.	€/m
----------------	-----------	-------------	-----

301 Klick-Sockelleiste 60 x 15 mm, Aluminium eloxiert, inkl. 6 Stück Wandhalterungen mit Schrauben und Dübel zur Befestigung

click skirting 60 x 15 mm, aluminum anodized, incl. 6 wall holders with screws and dowels for fastening

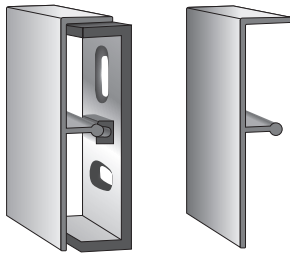

silber eloxiert silver anodised	2,5	61978-9	
------------------------------------	-----	---------	--

edelstahlfarbig / AL-INOX stainless steel coloured	2,5	61980-2	
---	-----	---------	--

Andere Farben auf Anfrage / other colours on demand

Zubehör für Klick-Sockelleiste 60 x 15 mm / accessories for click skirting 60 x 15 mm

Farbe + Material / material + colour	Art. / ref.	€
--------------------------------------	-------------	---

302 Außenecke für Klicksockelleiste 60 x 15 mm

outside corner for click skirting

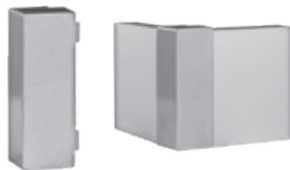

Kunststoff silberfarbig plastic silver coloured	61984-0	
--	---------	--

Kunststoff edelstahlfarbig plastic stainless steel coloured	61992-5	
--	---------	--

303 Innenecke für Klicksockelleiste 60 x 15 mm

inside corner for click skirting



Kunststoff silberfarbig plastic silver coloured	61986-4	
--	---------	--

Kunststoff edelstahlfarbig plastic stainless steel coloured	61994-9	
--	---------	--

304 Verbinder für Klicksockelleiste 60 x 15 mm

connecting piece for click skirting



Kunststoff silberfarbig plastic silver coloured	61988-8	
--	---------	--

Kunststoff edelstahlfarbig plastic stainless steel coloured	61996-3	
--	---------	--

305 Endstücke, 1 Paar, für Klicksockelleiste 60 x 15 mm

end caps, 1 pair, for click skirting



Kunststoff silberfarbig plastic silver coloured	61990-1	
--	---------	--

Kunststoff edelstahlfarbig plastic stainless steel coloured	61998-7	
--	---------	--



9. Fliesentrenn-, Dehnungsfugen-, Bau- & T-Profile aus Aluminium, Edelstahl, Messing & PVC

9. ceramic tile separation profiles + expansion gap profiles + building profiles + T-profiles out of aluminium + stainless steel + brass + PVC

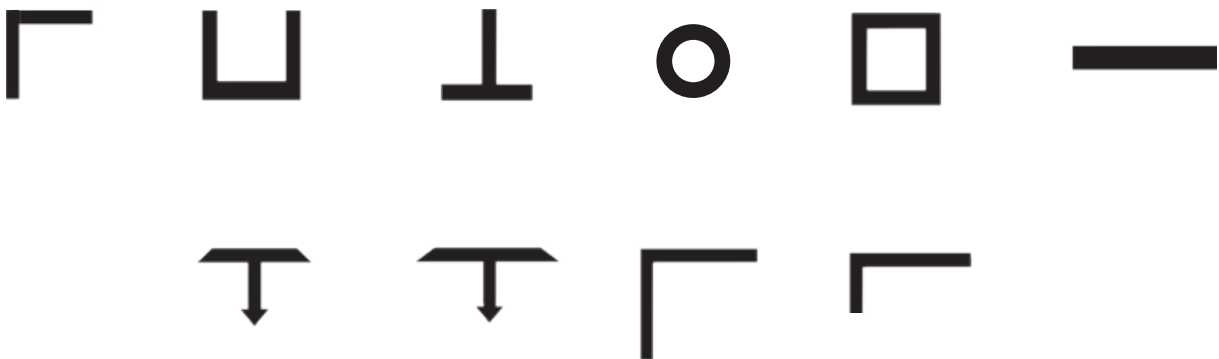
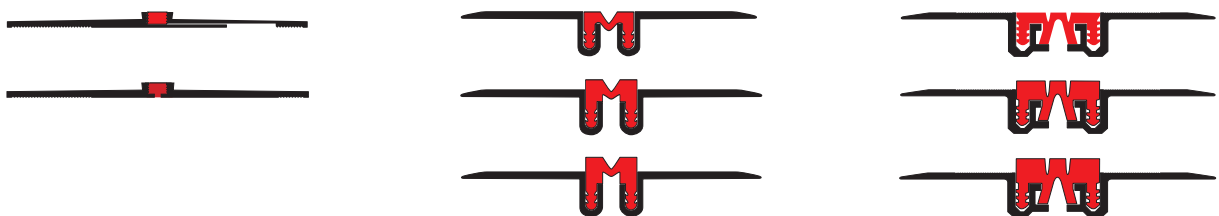

9



Fliesentrennprofil

ceramic file separation profile

Fliesentrennprofil mit breitem Auflegeschenkel

ceramic tile separation profile with wide contact surface

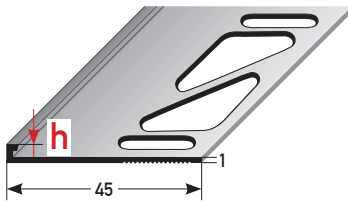

518

Innenmaß / inside measure						
Material / material	L / l (m)	Stk. / VE / pcs / unit	Innenhöhe / inside height (mm)	Art. / ref.	€ / m	€/Stück / pcs.
Aluminium pressblank aluminium mill-finish	2.7 m	10	2,5	72250-2		
			3	71804-8		

$h = \text{Innenmaß} / \text{Außenmaß} = h + 1 \text{ mm}$

$h = \text{inside dimension} / \text{external dimension} = h + 1 \text{ mm}$

Dehnungsfugenprofile auf Anfrage produzierbar!
Expansion gap profiles can be produced on request!

Fliesentrennprofil

ceramic tile separation profile

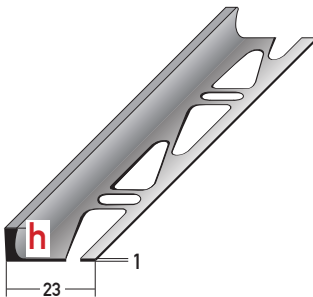

32

Aluminium pressblank aluminium mill-finish	1.0 m	10	2	71808-6		
			2,5	71810-9		
			3	71812-3		
			4,5	71814-7		
			6	71816-1		
Aluminium pressblank aluminium mill-finish	2.5 m	10	2	30129-5		
			2,5	30135-6		
			3	30130-1		
			4,5	30140-0		
			6	30150-9		
			8	30160-8		
			10	30170-7		
			11	30175-2		
			12,5	30180-6		
			15	30190-5		
			18	30766-2		
			20	30767-9		
			22	30195-0		
			25	30768-6		
			30	30769-3		

$h = \text{Innenmaß}$
 $\text{Außenmaß} = h + 1 \text{ mm}$

$h = \text{inside dimension}$
 $\text{external dimension} = h + 1 \text{ mm}$

Andere Größen oder Eloxalfarben auf Anfrage möglich

other sizes or anodized colours available on request

32

Aluminium silber eloxiert aluminium silver anodized	2.5 m	10	2	69582-0		
			2,5	69584-4		
			3	69586-8		
			4,5	69588-2		
			6	69590-5		

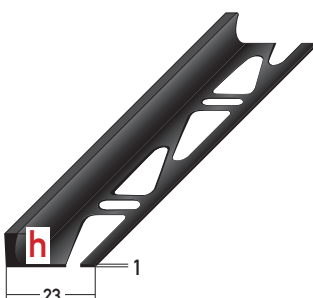

32

Aluminium schwarz eloxiert aluminium black anodized	2.5 m	10	2	69594-3		
			2,5	69596-7		
			3	69598-1		
			4,5	69600-1		
			6	69602-5		
			8	72480-3		
			10	72482-7		
			11	72484-1		
			12,5	72486-5		
			15	72488-9		

NEU!
NEU!
NEU!
NEU!
NEU!



Fliesentrennprofil

ceramic file separation profile

Fliesentrennprofil

ceramic tile separation profile

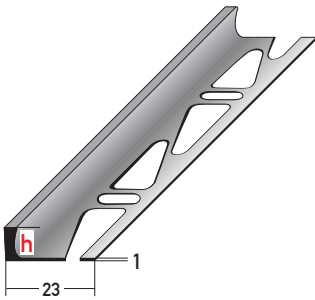

h = Innenmaß
Außenmaß = h + 1 mm

h = inside dimension
external dimension = h + 1 mm

* Bestand muss geprüft werden /
alternativ Aluminium goldfarbig
eloxiert anfragen /

stock has to be checked / alter-
natively ask for gold coloured
anodized aluminium

Innenmaß / inside measure

Material / material	L / l (m)	Stk. / VE / pcs / unit	Höhe / height (mm)	Art. / ref.	€/m	€/Stück / pcs.
---------------------	-----------	------------------------	--------------------	-------------	-----	----------------

Messing pressblank brass mill-finish 	2,5 m	10	3	30010-6		
			4,5*	30020-5		
			6	30030-4		
			8	30040-3		
			10	30050-2		
			12,5	30060-1		
			15	30070-0		
22	30075-5					

Edelstahl stainless steel 	1,0 m	10	2	71820-8		
			2,5	71822-2		
			3	71824-6		
			4,5	71826-0		
			6	71828-4		

Edelstahl stainless steel 	2,5 m	10	2	30072-4		
			2,5	30765-5		
			3	30073-1		
			4,5	30074-8		
			6	30080-9		
			8	30090-8		
			10	30100-4		
			11	30105-9		
			12,5	30110-3		
			15	30120-2		
			17	30123-3		
			20	30762-4		
			22	30125-7		
			25	30763-1		
30	30764-8					

PVC weiß PVC white	2,5 m	10	6	30340-4		
			8	30350-3		
			10	30360-2		
PVC beige PVC beige			6	30370-1		
			8	30380-0		
			10	30390-9		
PVC grau PVC grey			6	30400-5		
			8	30410-4		
			10	30420-3		



Flexibles Fliesentrennprofil

flexible ceramic file separation profile

Innenmaß / inside measure

Material/ material	L / l (m)	Stk./VE/ pcs/unit	Höhe/ height (mm)	Art./ref.	€/m	€/Stück/pcs.
-----------------------	-----------	----------------------	----------------------	-----------	-----	--------------

Flexibles Fliesentrennprofil

flexible ceramic tile separation profile

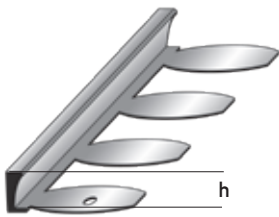

35

Aluminium pressblank aluminium mill-finish	2,5 m	10	2	30268-1		
			3	30270-4		
			4,5	30280-3		
			6	30290-2		
			8	30300-8		
			10	30310-7		
			12,5	30320-6		
			15	30330-5		
			18	69606-3		
			20	69608-7		
			22	30335-0		
			25	69612-4		
30	69614-8					

165

Messing pressblank brass mill-finish	2,5 m	10	3	30200-1		
			4,5*	30210-0		
			6	30220-9		
			8	30230-8		
			10	30240-7		
			12,5	30250-6		
			15	30260-5		
22	30265-0					

h = Innenmaß
Außenmaß = h + 1 mm

h = inside dimension
external dimension = h + 1 mm

* Bestand muss geprüft werden /
alternativ Aluminium goldfarbig
eloxiert anfragen /

stock has to be checked / alter-
natively ask for gold coloured
anodized aluminium

166

Edelstahl stainless steel	2,5 m	10	3	38000-9		
			4,5	38010-8		
			6	38020-7		
			8	38030-6		
			10	38040-5		
			12,5	38050-4		
15	38060-3					

Biegegerät für flexible Fliesentrennprofile

bending machine for flexible ceramic tile
separation profiles



Art./ref.	€/Stück/pcs.
31050-1	

MIET-Biegegerät für flexible Fliesentrennprofile für 14-tägige Nutzung

rental bending machine for flexible ceramic tile
separation profiles for 14 days of use



Art./ref.	€/Stück/pcs.
71832-1	

Verfügbarkeit auf Anfrage / availability on request

Mietzeit beginnt am Paketzustellungstag / rental period begins on the day of delivery of the package

Rückversand durch Kunde / return shipment by customer



Dehnungsprofilprofil Aluminium, VE 10 Stück

expansion gap profiles aluminium, sales unit 10 pcs.

Material/ Farbe material/ colour	Silikonfarbe silicone colour	Länge length (m)	Innenhöhe inside height (mm)	Art./ ref.	€/ m	€/Stück/ pcs.
-------------------------------------	---------------------------------	---------------------	---------------------------------	------------	------	---------------

Dehnungsfugenprofil mit grauer Silikoneinlage

expansion gap profile with grey silicone insert

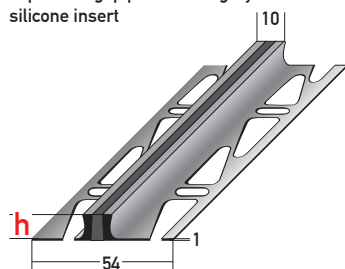

h = Innenmaß
Außenmaß = h + 1 mm
h = inside dimension
external dimension = h + 1 mm

Dehnungsfugenprofile aus Profilnr. 518 mit breitem Auflageschenkel auf Anfrage produzierbar!

Expansion gap profiles from profile no. 518 with a wide support leg can be produced on request!

31

Aluminium pressblank aluminium mill-finish	Silikon grau	1.0 m	2	71836-9		
			2,5	71838-3		
			3	71840-6		
			4,5	71842-0		
			6	71844-4		
		2.5 m	2	37630-9		
			2,5	37105-2		
			3	37100-7		
			4,5	37600-2		
			6	36230-2		
			8	36240-1		
			10	36250-0		
			11	36255-5		
		3.0 m*	2	72492-6		
			2,5	72494-0		
			3	72496-4		
			4,5	72498-8		
			6	72500-8		
Aluminium silber eloxiert aluminium silver anodized	Silikon grau	2.5 m	2	72504-6		
			2,5	72506-0		
			3	72508-4		
			4,5	72510-7		
			6	72512-1		



* 3.0 m-Ware ist nur per Spedition lieferbar (gesonderte Transportkosten)

*3.0 m profiles are only available per forwarding agency (separate transport costs)

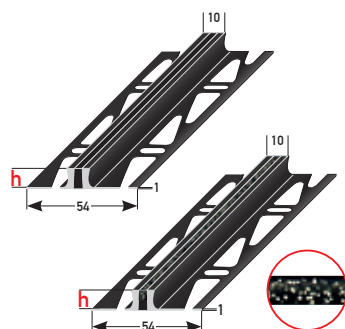

Aluminium schwarz eloxiert aluminium black anodized	Silikon schwarz	2.5 m	2	69620-9		
			2,5	69622-3		
			3	69624-7		
			4,5	69626-1		
			6	69628-5		
Aluminium schwarz eloxiert aluminium black anodized	Silikon schwarz	2.5 m	2	69634-6		
			2,5	69636-0		
			3	69638-4		
			4,5	69640-7		
			6	69642-1		
	Silikon silber Diamant- Glitter	2.5 m	2	69648-3		
			2,5	69650-6		
			3	69652-0		
			4,5	69654-4		
			6	69656-8		

Farbige Silikoneinlagen nach Farbauswahl von Otto Chemie, sowie RAL und NCS

choice of colours by Otto Chemie, RAL colours and NCS

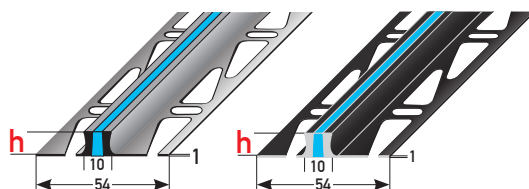

bis 25 m je Farbe up to 25 m of a colour

--> 30 % Preisauflschlag 30 % additional charge

ab 25 m je Farbe from 25 m of a colour

--> 15 % Preisauflschlag 15 % additional charge

ab 100 m je Farbe from 100 m of a colour

--> kein Preisauflschlag no additional charge

Dehnungsfugenprofile, VE 10 Stück

expansion gap profiles, sales unit 10 pcs.

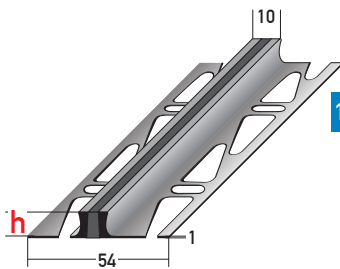

167

Material / Farbe material / colour	Silikonfarbe silicone colour	Länge length (m)	Innenhöhe inside height (mm)	Art. / ref.	€/m	€/Stück / pcs.
Messing pressblank brass mill-finish	Silikon grau	2,5 m	3	37110-6		
			4,5*	37610-1		
			6	36290-6		
			8	36300-2		
			10	36310-1		
			12,5	37642-2		
			15	37644-6		
25	37646-0					
Edelstahl stainless steel	Silikon grau	1,0 m	2	71848-2		
			2,5	71850-5		
			3	71852-9		
			4,5	71854-3		
			6	71856-7		
		2,5 m	2	37650-7		
			2,5	37651-4		
			3	37115-1		
			4,5*	37620-0		
			6	36350-7		
			8	36360-6		
			10	36370-5		
			11	36375-0		
			12,5	37652-1		
15	37654-5					
25	37656-9					



168

* Bestand muss geprüft werden / alternativ Aluminium goldfarbig eloxiert anfragen /

stock has to be checked / alternatively ask for gold coloured anodized aluminium

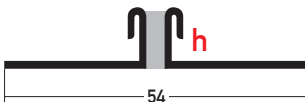

h = Innenmaß
Außenmaß = h + 1 mm
h = inside dimension
external dimension = h + 1 mm

Farbige Silikoneinlagen nach Farbauswahl von Otto Chemie, sowie RAL- und NCS:
choice of colours by Otto Chemie, RAL colours and NCS:

bis 25 m je Farbe / up to 25 m of a colour --> 30 % Preiszuschlag / 30 % additional charge
ab 25 m je Farbe / from 25 m of a colour --> 15 % Preiszuschlag / 15 % additional charge
ab 100 m je Farbe / from 100 m of a colour --> **kein** Preiszuschlag / no additional charge

Lieferzeit auf Anfrage / delivery time on request

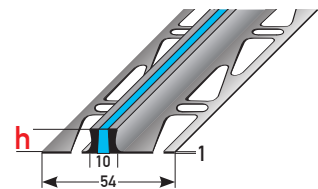

169 PVC-Dehnungsfugenprofil

PVC-expansion gap profile

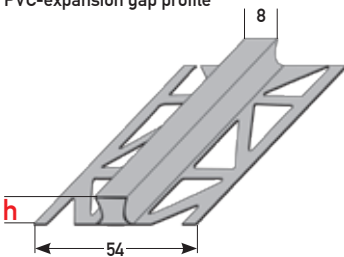

Farbe colour	Länge length (m)	Innenhöhe inside height (mm)	Art. / ref.	€/m	€/Stück / pcs.
PVC weiß PVC white	2,5 m	6	36440-5		
PVC beige PVC beige			36500-6		
PVC grau PVC grey			36560-0		

281 Wellenverbinder 70 x 6 mm, zur Beseitigung von Estrichrissen

wave connector 70 x 6 mm,
for fixing concrete floor cracks

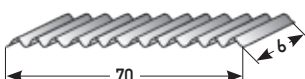

Stk. / Verpackung pcs / pack	Stk. / VE pcs. / unit	Art. / ref.	€
Karton á 1000 Stk. box á 1000 pcs.	1	36620-1	
Beutel á 100 Stk. bag á 100 pcs.	10	36621-8	



Ihre Wunschzusammenstellung war noch nicht dabei?

Kein Problem - individuell auf Anfrage erhältlich!

Other leg colours or ruby glitter, emerald glitter or multi glitter available on request.

Andere Profilfarben, farbige Silikoneinlagen, andere Füllungen, verlegefertige T- oder X-Dehnungsfugenkreuze, u.v.m. fertigen wir gern für Sie individuell nach Ihren Wünschen!

Your desired compilation was not included? No problem - individually available on request! We would be happy to manufacture other leg colours, coloured silicone inserts, other fillings, ready-to-lay T or X expansion spacers and much more according to your wishes!

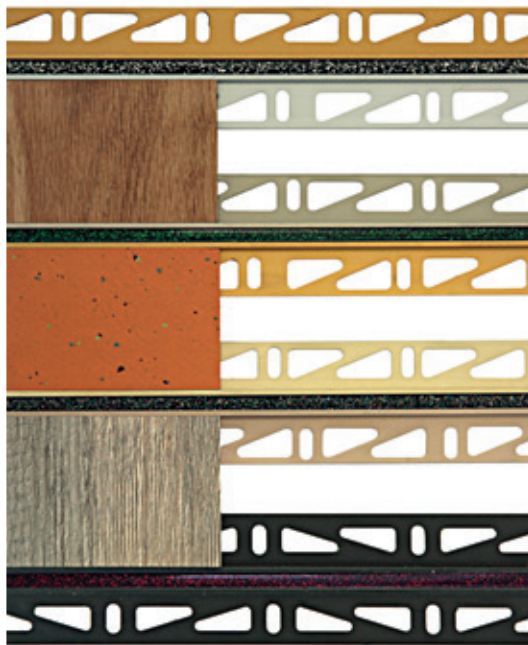

Diamant-Glitter
diamond glitter



Smaragd-Glitter
emerald glitter

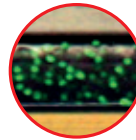

Multi-Glitter
multi glitter

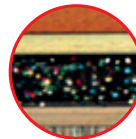

Rubin-Glitter
ruby glitter



Bild 1: Glittervarianten mit schwarzer Silikonbasis
Image 1: Glitter variants with a black silicone base

Bild 1: Dehnungsfugenprofil h=2,5 mm mit breiten Auflegeschenkeln mit schwarzer Silikonereinlage
Image 2: Expansion joint profile h=2.5 mm with wide support legs with black silicone insert

9

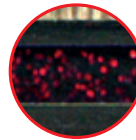

Bild 3: T-Dehnungsfugenkreuz
Image 3: T-expansion joint cross



Bild 4: X-Dehnungsfugenkreuz
Image 4: X-expansion joint cross



Spezial-Dehnungsfugenprofile

special expansion gap profile

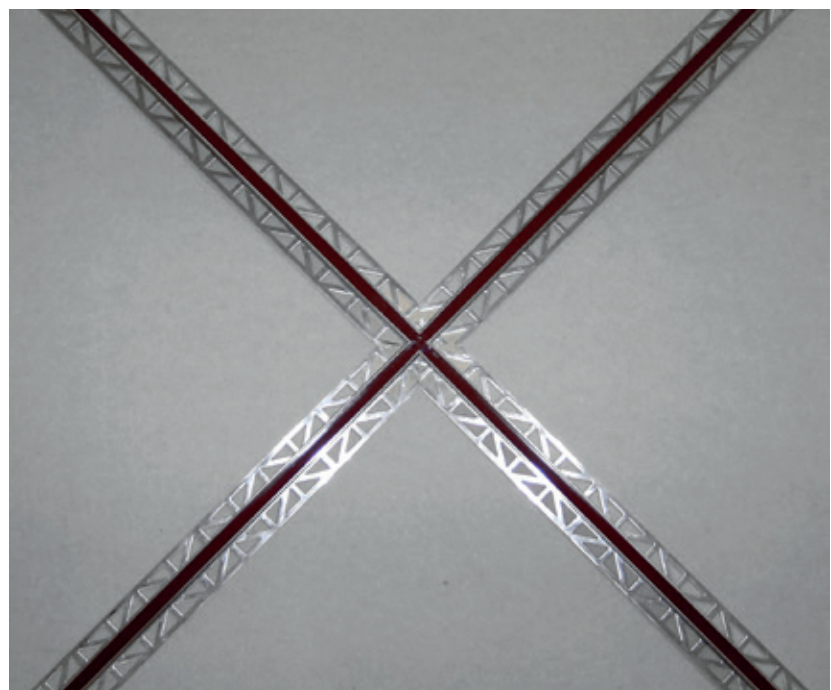
Innenmaß / inside measure

Material/ material	L / l (m)	Stk./VE/ pcs/unit	Höhe/ height (mm)	Art./ref.	€/m	€/Stück/pcs.
-----------------------	-----------	----------------------	----------------------	-----------	-----	--------------

322 Spezial-Dehnungsfugenprofil, Fugenbreite bis 20 mm, gebohrt

special expansion gap profile,
joint width up to 20 mm, drilled

für starke Belastungen
for heavy loads

Füllbereich 10 mm.
gefüllt mit grauem Silikon
fill area 10 mm,
filled with grey silicone

Aluminium pressblank aluminium mill-finish	2,5 m	10	2,2	37728-3		
			2,8	37730-6		
			3,7	37768-9		
			5,0	37770-2		

andere Silikonfugenbreite auf
Anfrage gegen Aufpreis (15%)
möglich
other silicone joint width on request
for an additional charge (15%) possible

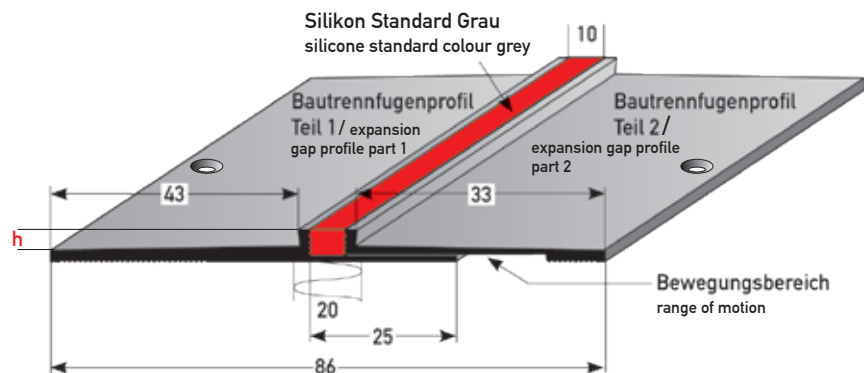

479 Spezial-Dehnungsfugenprofil, 3-dimensional beweglich, Fugenbreite bis 20 mm, gebohrt

special expansion gap profile,
3-dimensionally movable,
joint width up to 20 mm, drilled

für starke Belastungen
for heavy loads

Füllbereich 10 mm.
gefüllt mit grauem Silikon
fill area 10 mm,
filled with grey silicone

Aluminium pressblank aluminium mill-finish	2,5 m	10	2,2	70896-4		
			2,8	70898-8		

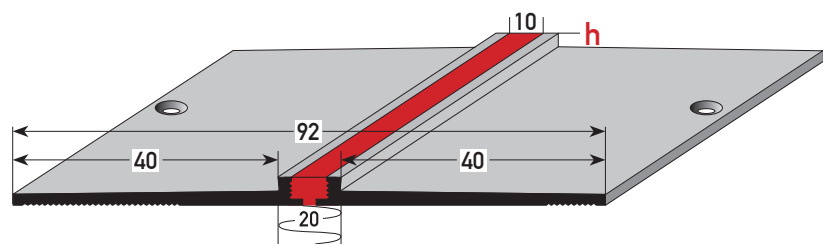

Farbige Silikoneinlagen nach Farbauswahl von Otto Chemie, sowie RAL- und NCS:
choice of colours by Otto Chemie, RAL colours and NCS:

bis 25 m je Farbe / up to 25 m of a colour --> 30 % Preisauflschlag / 30 % additional charge

ab 25 m je Farbe / from 25 m of a colour --> 15 % Preisauflschlag / 15 % additional charge

ab 100 m je Farbe / from 100 m of a colour --> kein Preisauflschlag / no additional charge

Lieferzeit auf Anfrage / delivery time on request



Dehnungsfugenprofile „SUPER 20“ für nachträglichen Einbau

expansion gap profile „SUPER 20“ – for subsequent installation

Innenmaß / inside measure

Material / material	L / l (m)	Stk./VE / pcs/unit	Höhe / height (mm)	Art./ref.	€/m	€/Stück / pcs.
---------------------	-----------	--------------------	--------------------	-----------	-----	----------------

323 Super-Dehnungsfugenprofil TYP 20/12, für über 20 mm Fugenbreite, gebohrt, mit grauer PVC-Einlage, für nachträglichen Einbau, zum Aufsetzen auf den Bodenbelag

super expansion gap profile type 20/12, for over 20 mm joint width, drilled, with grey PVC insert, for subsequent installation, to be placed on the flooring

Aluminium pressblank aluminium mill-finish	2.0 m	10	-	37734-4		
	4.0 m			37736-8		

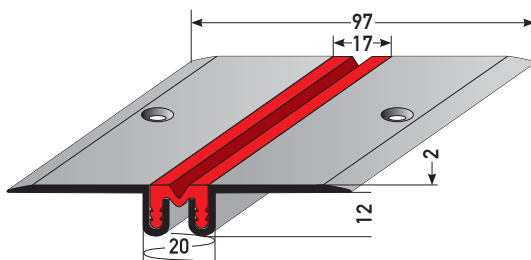

324 Super-Dehnungsfugenprofil TYP 20/12/3, für über 20 mm Fugenbreite, gebohrt, mit grauer PVC-Einlage, für nachträglichen Einbau, zum Anstoßen von 3 mm Belag

super expansion gap profile type 20/12/3, for over 20 mm joint width, drilled, with grey PVC insert, for subsequent installation, for abutting 3 mm flooring

Aluminium pressblank aluminium mill-finish	2.0 m	10	3	37740-5		
	4.0 m			37742-9		

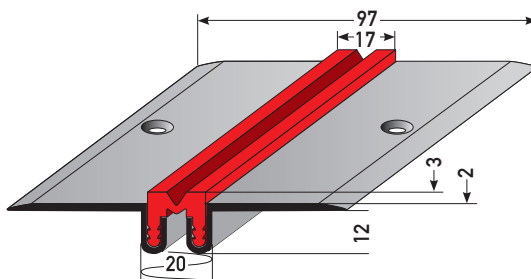

482 Super-Dehnungsfugenprofil TYP 20/12/5, für über 20 mm Fugenbreite, gebohrt, mit grauer PVC-Einlage, für nachträglichen Einbau, zum Anstoßen von 5 mm Belag

super expansion gap profile type 20/12/5, for over 20 mm joint width, drilled, with grey PVC insert, for subsequent installation, for abutting 5 mm flooring

Aluminium pressblank aluminium mill-finish	2.0 m	10	5	70976-3		
	4.0 m			70978-7		

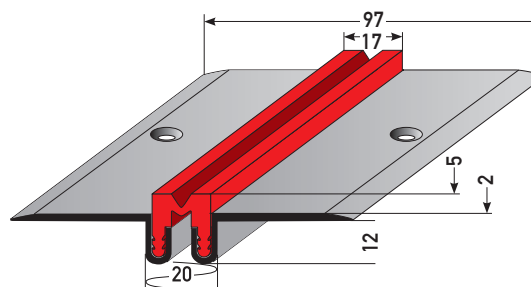

4,0 m Ware ist nur per Spedition lieferbar (gesonderte Transportkosten)
4,0 m profiles are only available per forwarding agency (separate transport costs)



Dehnungsfugenprofile „SUPER 35“ für nachträglichen Einbau

expansion gap profile „SUPER 35“ – for subsequent installation

Innenmaß/ inside measure

Material/ material	L / l (m)	Stk./VE/ pcs / unit	Höhe/ height (mm)	Art./ref.	€/m	€/Stück/ pcs.
-----------------------	-----------	------------------------	-------------------------	-----------	-----	------------------

325

Super-Dehnungsfugenprofil TYP 35/15, für über 35 mm Fugenbreite, gebohrt, mit grauer PVC-Einlage, für nachträglichen Einbau, zum Aufsetzen auf den Bodenbelag

super expansion gap profile type 35/15, for over 35 mm joint width, drilled, with grey PVC insert, for subsequent installation, to be placed on the flooring

Aluminium pressblank aluminium mill-finish	2,0 m	10	-	37746-7		
	4,0 m			37748-1		

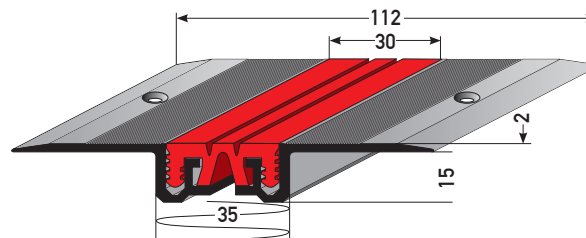

326

Super-Dehnungsfugenprofil TYP 35/15/3, für über 35 mm Fugenbreite, gebohrt, mit grauer PVC-Einlage, für nachträglichen Einbau, zum Anstoßen von 3 mm Belag

super expansion gap profile type 35/15/3, for over 35 mm joint width, drilled, with grey PVC insert, for subsequent installation, for abutting 3 mm flooring

Aluminium pressblank aluminium mill-finish	2,0 m	10	3	37752-8		
	4,0 m			37754-2		

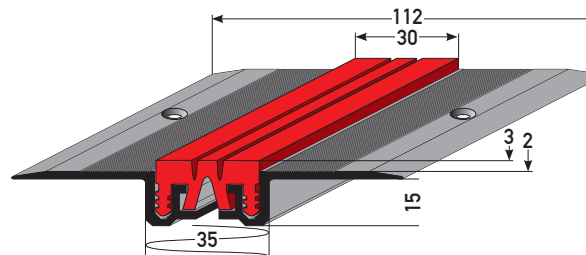

484

Super-Dehnungsfugenprofil TYP 35/15/5, für über 35 mm Fugenbreite, gebohrt, mit grauer PVC-Einlage, für nachträglichen Einbau, zum Anstoßen von 5 mm Belag

super expansion gap profile type 35/15/5, for over 35 mm joint width, drilled, with grey PVC insert, for subsequent installation, for abutting 5 mm flooring

Aluminium pressblank aluminium mill-finish	2,0 m	10	5	70982-4		
	4,0 m			70984-8		

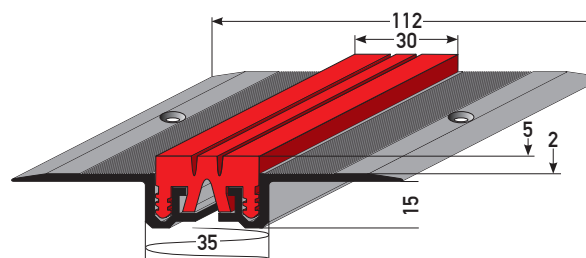

4,0 m Ware ist nur per Spedition lieferbar (gesonderte Transportkosten)
4,0 m profiles are only available per forwarding agency (separate transport costs)

andere Längen + Abmessungen
auf Anfrage / other lengths and
dimensions on demand

Lagerlängen à 6 m
in stock lengths à 6 m

170 Winkelprofil

angle edge

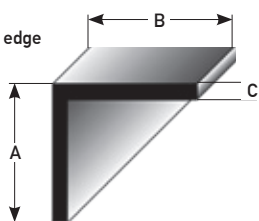

Aluminium-Bau-Profile pressblank (Außenmaße)				
aluminium building profiles silver anodized (outside measures)				
L/l (m)	VE/unit	AxBxC mm	Art./ref.	€/Stück/pcs.
1.0	10	10 x 10 x 2	37120-5	
		15 x 15 x 2	37122-9	
		20 x 20 x 2	37130-4	
		25 x 25 x 2	37132-8	
		30 x 30 x 2	37140-3	
2.0	10	10 x 10 x 2	37150-2	
		15 x 15 x 2	37152-6	
		20 x 20 x 2	37160-1	
		25 x 25 x 2	37162-5	
		30 x 30 x 2	37170-0	

171 U-Profil

U-profile

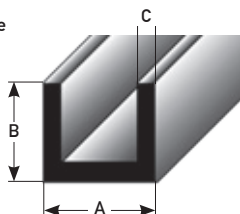

1.0	10	10 x 10 x 2	37180-9	
		15 x 15 x 2	37182-3	
		20 x 20 x 2	37190-8	
		30 x 30 x 3	37200-4	
2.0	10	10 x 10 x 2	37210-3	
		15 x 15 x 2	37212-7	
		20 x 20 x 2	37220-2	
		30 x 30 x 3	37230-1	

172 T-Profil

T-profile

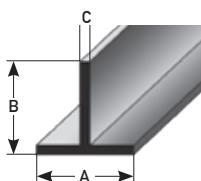

1.0	10	20 x 20 x 2	37240-0	
		25 x 25 x 3	37250-9	
		30 x 30 x 3	37260-8	
2.0	10	20 x 20 x 2	37270-7	
		25 x 25 x 3	37280-6	
		30 x 30 x 3	37290-5	

173 Rohr

pipe

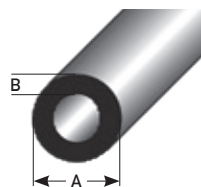

1.0	10	10 x 1	37300-1	
		12 x 1	37310-0	
		16 x 2	37320-9	
2.0	10	10 x 1	37330-8	
		12 x 1	37340-7	
		16 x 2	37350-6	

174 Flachprofil

flat profile

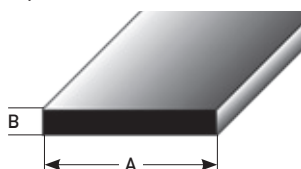

1.0	10	10 x 2	37360-5	
		15 x 2	37362-9	
		20 x 2	37364-3	
		30 x 2	37370-4	
		40 x 3	37380-3	
2.0	10	10 x 2	37390-2	
		15 x 2	37392-6	
		20 x 2	37394-0	
		30 x 2	37400-8	
		40 x 3	37410-7	

175 Vierkantrrohr

rectangular pipe

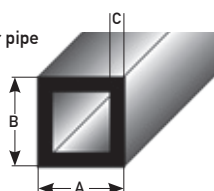

1.0	10	15 x 15 x 1,5	37420-6	
		20 x 20 x 2	37430-5	
		30 x 30 x 3	37440-4	
2.0	10	15 x 15 x 1,5	37450-3	
		20 x 20 x 2	37460-2	
		30 x 30 x 3	37470-1	



Lagerlängen à 6 m / in stock lengths à 6 m

* kann 40 mm Klemmstelle an einer Seite vom Eloxieren enthalten
may contain 40 mm clamping point on one side from anodizing

178 Winkelprofil
gleichschenkelig
angle edge, equal size sides

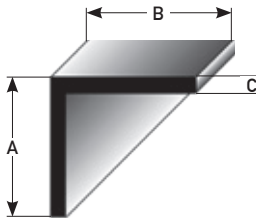

Aluminium-Bau-Profile silber eloxiert (Außenmaße)				
aluminium building profiles silver anodized (outside measures)				
L/l (m)	VE/unit	AxBxC mm	Art./ref.	€/Stück/ pcs.
1.0	10	10 x 10 x 1	45000-9	
		15 x 15 x 1	45002-3	
		20 x 20 x 1.5	45004-7	
		25 x 25 x 1.5	45006-1	
		30 x 30 x 1.5	45008-5	
		40 x 40 x 1.5	45010-8	
2.0	10	10 x 10 x 1	45016-0	
		15 x 15 x 1	45018-4	
		20 x 20 x 1.5	45020-7	
		25 x 25 x 1.5	45022-1	
		30 x 30 x 1.5	45024-5	
		40 x 40 x 1.5	45026-9	

179 Winkelprofil
ungleichschenkelig
angle edge, different size sides

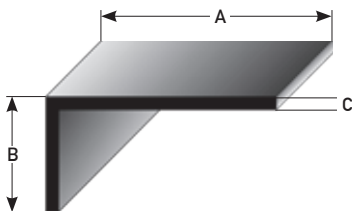

1.0 m*	10	15 x 10 x 1	45032-0	
		20 x 15 x 1.5	45034-4	
		25 x 15 x 1.5	45036-8	
		30 x 20 x 1.5	45038-2	
		40 x 20 x 1.5	45040-5	
2.0 m*	10	15 x 10 x 1	45046-7	
		20 x 15 x 1.5	45048-1	
		25 x 15 x 1.5	45050-4	
		30 x 20 x 1.5	45052-8	
		40 x 20 x 1.5	45054-2	

andere Längen + Abmessungen auf Anfrage / other lengths and dimensions on demand



**inklusive 40 mm Klemmstelle an einer Seite vom Eloxieren including 40 mm clamping point on one side from anodizing

25 T-Profil 14 mm für Übergänge

T-profile 14 mm for transition

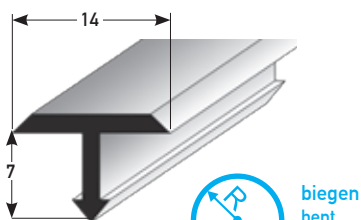

Fußboden - T - Profile					
T - profiles					
Material + Farbe / material + colour	Höhe / height	L / l (m)	Art. / ref.	€ / m	€ / Stück / pcs.
Messing ziehblank brass mill-finish	7 mm	2,5 m	36380-4		
Alu blank aluminium mill-finish			36390-3		
Alu silberfarbig aluminium silver			46630-7		
Alu goldfarbig aluminium gold			46632-1		
Alu bronzefarbig hell aluminium bonze light		2,5 m**	46634-5		
Alu bronzefarbig dunkel aluminium bonze dark			46636-9		
Edelstahl matt stainless steel matt	7 mm	1,0 m	72362-2		
		2,5 m	36420-7		
		3,0 m*	72364-6		

*** 3,0 m-Ware ist nur per Spedition lieferbar (gesonderte Transportkosten)**
3.0 m profiles are only available per forwarding agency (separate transport costs)

26 T-Profil 25 mm für Übergänge

T-profile 25 mm for transition

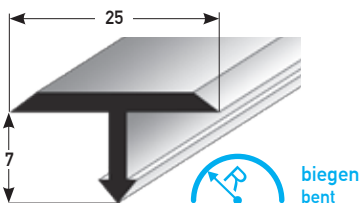

Messing ziehblank brass mill-finish	7 mm	2,5 m	36400-9		
Alu blank aluminium mill-finish			36410-8		
Alu silberfarbig aluminium silver			46640-6		
Alu goldfarbig aluminium gold			46642-0		
Alu bronzefarbig hell aluminium bonze light		2,5 m**	46644-4		
Alu bronzefarbig dunkel aluminium bonze dark			46646-8		
Edelstahl matt stainless steel matt	7 mm	1,0 m	72366-0		
		2,5 m	36430-6		
		3,0 m*	72368-4		

*** 3,0 m-Ware ist nur per Spedition lieferbar (gesonderte Transportkosten)**
3.0 m profiles are only available per forwarding agency (separate transport costs)



Profil biegen – auf Anfrage
bent profile – on request

483 Befestigungsdübel für T-Profile

fixing dowel for T-profiles

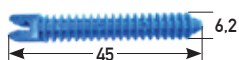

Abmaß / dimension	Stk. / Verpack. pcs. / pack	Art. / ref.	€ / Btl. / bag
45 x 6,2 mm	Btl. / bag à 10	70988-6	

10. Läuferstangen aus Messing und Edelstahl

10. stair rods out of brass + stainless steel

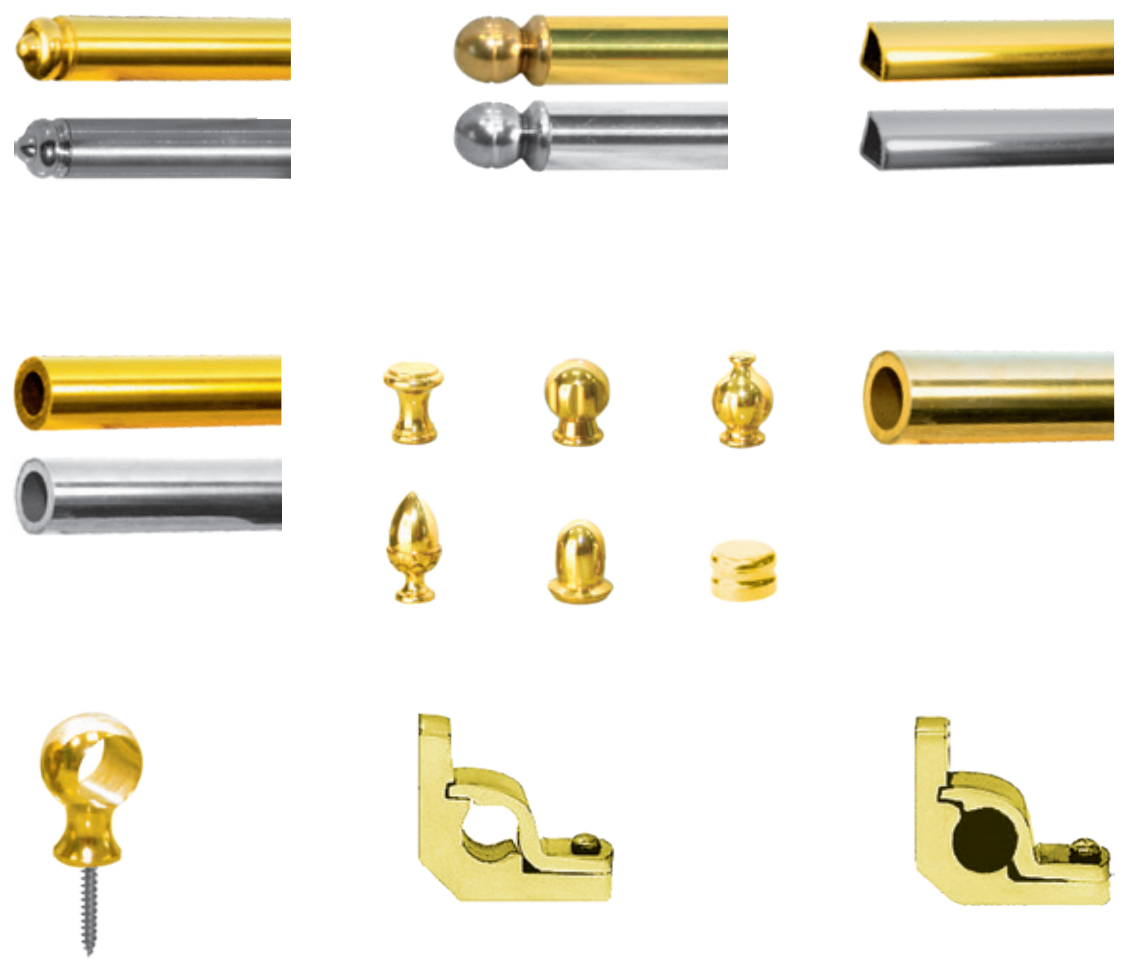

10



10. LÄUFERSTANGEN / 10. STAIR RODS

Achtung: Der Aufpreis für die Anfertigung von Sonderlängen beträgt 15% zuzügl. Verschnitt!

Note: There is a 15% surcharge for special length cuts plus waste!

Der Läuferstangendurchmesser ist nach Läuferart und Verlegetechnik zu wählen! Wir beraten Sie gern!

Stair rod diameter should be selected according to type of carpet and laying technology! We advise you gladly!

Läuferstange ø 10 mm

stair rod ø 10 mm

Material/material	L/l (m)	Art./ref.	€
-------------------	---------	-----------	---

74 Läuferstange ø 10 x 0,8 mm Messing / stair rod ø 10 mm x 0,8 mm brass

Abschlussknöpfe werden in die Gesamtlänge eingerechnet
endings are included in the full length



Messing-Rohr poliert, lackiert, inkl. Messingabschlussknöpfe brass pipe polished, painted, with brass endings	0,75	05770-3	
	0,8	05780-2	
	0,9	05790-1	
	1,0	05800-7	
	1,1	05810-6	
	1,2	05820-5	
	1,3	05830-4	

Messing-Rohr mit Stahlkern poliert, lackiert, inkl. Messingabschlussknöpfe brass pipe with steel core, polished, painted, with brass endings	0,75	05813-7	
	0,8	05814-4	
	0,9	05815-1	
	1,0	05816-8	
	1,1	05817-5	
	1,2	05818-2	
	1,3	05819-9	

371 Läuferstange ø 10 x 1,5 mm Edelstahl poliert / stair rod ø 10 x 1,5 mm stainless steel polished

Abschlussknöpfe werden in die Gesamtlänge eingerechnet
endings are included in the full length



Edelstahl-Rohr poliert inkl. vernickelter Abschlussknöpfe stainless steel pipe polished, with nickel plated endings	0,75	66346-1	
	0,8	66348-5	
	0,9	66350-8	
	1,0	66352-2	
	1,1	66354-6	
	1,2	66356-0	
	1,3	66358-4	

75 Läuferstange ø 10 x 1,5 mm Edelstahl matt / stair rod ø 10 x 1,5 mm stainless steel mat

Abschlussknöpfe werden in die Gesamtlänge eingerechnet
endings are included in the full length



Edelstahl-Rohr matt inkl. matt vernickelter Abschlussknöpfe stainless steel pipe, matt, with matt nickel plated endings	0,75	38820-3	
	0,8	38830-2	
	0,9	38840-1	
	1,0	05450-4	
	1,1	38850-0	
	1,2	38860-9	
	1,3	38870-8	

429 Läuferstange ø 10 x 0,8 mm Messing brüniert / stair rod ø 10 mm x 0,8 mm brass burnished

Abschlussknöpfe werden in die Gesamtlänge eingerechnet
endings are included in the full length

Messing-Rohr brüniert mit Stahlkern inkl. brüniertes Abschlussknöpfe burnished brass pipe with steel core, with burnished brass endings	1,0	05100-8	
--	-----	---------	--

Brünier-Farbtone kann variieren /
colour of burnished brass can vary

Lieferzeit auf Anfrage / delivery time on request

76 Stahl-Läuferstange mit Dekorbeschichtung ø 10 x 1,5 mm / steel stair rod with decor coating ø 10 x 1,5 mm

inkl. Messingabschlussknöpfe
with brass endings

schwarz matt / black matt	1,0	05300-2	
Kupfer antik / copper antik		05350-7	
weiß / white		05400-9	

Nicht für den Außenbereich geeignet / not suitable for outdoor use

Zubehör für Läuferstange ø 10 mm

accessories for stair rod ø 10 mm

Material / material	Verpackung / unit	Art. / ref.	€
---------------------	-------------------	-------------	---

189 Kugelöse für Läuferstangen ø 10 mm, gedreht / ball eyelet for stair rod ø 10 mm, twisted

gedrehte Ausführung mit
Stockschraube M4
twisted execution with
hanger bolt M4



Feststellschraube
locking screw

Brünier-Farbtön kann variieren
colour of burnished brass can vary

Lieferzeit für brüniert auf Anfrage
delivery time for burnished brass
on request

Messing, poliert, lackiert brass, polished, painted	1 Stück / pcs.	05500-6	
Messing mit Feststellschraube poliert, lackiert brass with locking screw, polished, painted	1 Stück / pcs.	05700-0	
vernickelt nickel plated	1 Stück / pcs.	05600-3	
vernickelt mit Feststellschraube nickel plated with locking screw	1 Stück / pcs.	05705-5	
vernickelt matt nickel plated matt	1 Stück / pcs.	38890-6	
vernickelt matt mit Feststellschraube nickel plated matt with locking screw	1 Stück / pcs.	38900-2	
brüniert burnished brass	1 Stück / pcs.	05710-9	
brüniert mit Feststellschraube burnished brass with locking screw	1 Stück / pcs.	05720-8	

Kugelöse für Läuferstange ø 10 mm, gegossen / ball eyelet ø 10 mm, casted

Messing, poliert, lackiert brass, polished, painted	1 Stück / pcs.	39310-8	
vernickelt nickel plated	1 Stück / pcs.	39312-2	

Eindrehwerkzeug für Kugelösen 10 mm, Messing / tool for ball eyelets 10 mm, brass

zur Verwendung im Akkuschauber / for use in electric drills

39150-0	
---------	--

73 Klappöse ø 10 mm, offen / folding eyelet ø 10 mm, open

inkl. Schrauben & Dübel
incl. screws + dowels



Brünier-Farbtön kann variieren
colour of burnished brass can vary

Messing, poliert, lackiert brass, polished, painted	1 Paar / pair	05030-8	
vernickelt nickel plated	1 Paar / pair	05031-5	
vernickelt matt nickel plated matt	1 Paar / pair	38910-1	
brüniert burnished brass	1 Paar / pair	05050-6	

Lieferzeit für brüniert auf Anfrage / delivery time for burnished brass on request

190 Klappöse ø 10 mm, geschlossen / folding eyelet ø 10 mm, closed

inkl. Schrauben & Dübel
incl. screws + dowels



Brünier-Farbtön kann variieren
colour of burnished brass can vary

Messing, poliert, lackiert brass, polished, painted	1 Paar / pair	05040-7	
vernickelt nickel plated	1 Paar / pair	05041-4	
vernickelt matt nickel plated matt	1 Paar / pair	38920-0	
brüniert burnished brass	1 Paar / pair	05060-5	

Lieferzeit für brüniert auf Anfrage / delivery time for burnished brass on request



10. LÄUFERSTANGEN / 10. STAIR RODS

Achtung: Der Aufpreis für die Anfertigung von Sonderlängen beträgt 15% zuzügl. Verschnitt!

Note: There is a 15% surcharge for special length cuts plus waste!

Der Läuferstangendurchmesser ist nach Läuferart und Verlegetechnik zu wählen! Wir beraten Sie gern!

Stair rod diameter should be selected according to type of carpet and laying technology! We advise you gladly!

Läuferstange ø 13 mm

stair rod ø 13 mm

Material/material	L/l (m)	Art./ref.	€
-------------------	---------	-----------	---

197 Läuferstange ø 13 x 1,0 mm Messing / stair rod ø 13 mm x 1,0 mm brass

Abschlussknöpfe werden in die Gesamtlänge eingerechnet
endings are included in the full length



Messing-Rohr poliert, lackiert, inkl. Messingabschlussknöpfe brass pipe with steel core, polished, painted, with brass endings	0,9	05822-9	
	1,0	05823-6	
	1,2	05824-3	

Messing-Rohr mit Stahlkern poliert, lackiert, inkl. Messingabschlussknöpfe brass pipe with steel core, polished, painted, with brass endings	0,9	39100-5	
	1,0	39110-4	
	1,5	39120-3	

379 Läuferstange ø 13 x 1,0 mm Edelstahl poliert / stair rod ø 13 x 1,0 mm stainless steel polished

Abschlussknöpfe werden in die Gesamtlänge eingerechnet
endings are included in the full length



Edelstahl-Rohr poliert inkl. vernickelter Abschlussknöpfe stainless steel pipe polished, incl. endings	0,9	66466-6	
	1,0	66468-0	
	1,2	66472-7	

Edelstahl-Rohr poliert mit Stahlkern inkl. vernickelter Abschlussknöpfe stainless steel pipe polished, with steel core, incl. polished endings	0,9	66482-6	
	1,0	66484-0	
	1,5	66490-1	

430 Läuferstange ø 13 x 1,0 mm Edelstahl matt / stair rod ø 13 x 1,0 mm stainless steel mat

Abschlussknöpfe werden in die Gesamtlänge eingerechnet
endings are included in the full length



Edelstahl-Rohr matt inkl. matt vernickelter Abschlussknöpfe stainless steel pipe, matt, incl. endings	0,9	67538-9	
	1,0	67540-2	
	1,2	67544-0	

Edelstahl-Rohr matt mit Stahlkern inkl. matt vernickelter Abschlussknöpfe stainless steel pipe, matt, with steel core, incl. matt endings	0,9	67554-9	
	1,0	67556-3	
	1,5	67560-0	

431 Läuferstange ø 13 x 1,0 mm Messing brüniert / stair rod ø 13 x 1,0 mm brass burnished

Abschlussknöpfe werden in die Gesamtlänge eingerechnet
endings are included in the full length

Brünier-Farbtön kann variieren /
colour of burnished brass can vary

Messing-Rohr brüniert inkl. brüniertes Abschlussknöpfe burnished brass pipe, with burnished brass endings	1,0	67576-1	
---	-----	---------	--

Messing-Rohr brüniert mit Stahlkern inkl. brüniertes Abschlussknöpfe burnished brass pipe with steel core, with burnished brass endings	1,0	67592-1	
---	-----	---------	--

Lieferzeit auf Anfrage / delivery time on request

Zubehör für Läuferstange ø 13 mm

accessories for stair rod ø 13 mm

Material / material	Verpackung / unit	Art. / ref.	€
---------------------	-------------------	-------------	---

198 Kugelöse 13 mm, gedreht / ball eyelet 13 mm, twisted

gedrehte Ausführung mit
Stockschraube M4
twisted execution with
hanger bolt M4



Feststellschraube
locking screw

Brünier-Farbtön kann variieren
colour of burnished brass can vary

Messing, poliert, lackiert brass, polished, painted	1 Stück / pcs.	05825-0	
Messing mit Feststellschraube poliert, lackiert brass with locking screw, polished, painted	1 Stück / pcs.	05850-2	
vernickelt nickel plated	1 Stück / pcs.	39230-9	
vernickelt mit Feststellschraube nickel plated with locking screw	1 Stück / pcs.	39235-4	
vernickelt matt nickel plated matt	1 Stück / pcs.	39238-5	
vernickelt matt mit Feststellschraube nickel plated matt with locking screw	1 Stück / pcs.	39239-2	
brüniert burnished brass	1 Stück / pcs.	39236-1	
brüniert mit Feststellschraube burnished brass with locking screw	1 Stück / pcs.	39237-8	

Lieferzeit für brüniert auf Anfrage / delivery time for burnished brass on request

Eindrehwerkzeug für Kugelösen 13 mm, Messing / tool for ball eyelets 13 mm, brass

zur Verwendung im Akkuschauber
for use in electric drills

72254-0

199 Klappöse ø 13 mm, offen / folding eyelets ø 13 mm, open

inkl. Schrauben & Dübel
incl. screws + dowels



Brünier-Farbtön kann variieren
colour of burnished brass can vary

Messing, poliert, lackiert brass, polished, painted	1 Paar / pair	39130-2	
vernickelt nickel plated	1 Paar / pair	39240-8	
vernickelt matt nickel plated matt	1 Paar / pair	39131-9	
brüniert burnished brass	1 Paar / pair	39132-6	

Lieferzeit für brüniert auf Anfrage / delivery time for burnished brass on request

200 Klappöse ø 13 mm, geschlossen / folding eyelets ø 13 mm brass, closed

inkl. Schrauben & Dübel
incl. screws + dowels



Brünier-Farbtön kann variieren/
colour of burnished brass can vary

Messing, poliert, lackiert brass, polished, painted	1 Paar / pair	39140-1	
vernickelt nickel plated	1 Paar / pair	39245-3	
vernickelt matt nickel plated matt	1 Paar / pair	39141-8	
brüniert burnished brass	1 Paar / pair	39142-5	

Lieferzeit für brüniert auf Anfrage / delivery time for burnished brass on request



10. LÄUFERSTANGEN / 10. STAIR RODS

Achtung: Der Aufpreis für die Anfertigung von Sonderlängen beträgt 15% zuzügl. Verschnitt!
 Note: There is a 15% surcharge for special length cuts plus waste!

Der Läuferstangendurchmesser ist nach Läuferart und Verlegetechnik zu wählen! Wir beraten Sie gern!
 Stair rod diameter should be selected according to type of carpet and laying technology! We advise you gladly!

Zubehör für Läuferverlegung

accessories for runners laying

Material/material	Art./ref.	Verpackung/unit	€
-------------------	-----------	-----------------	---

68 Teppichschrauben mit Messingbuchse

carpet screw with metal casing



Messing brass	20562-3	SB-Beutel á 10 Stk. self-service bag á 10 pcs.	
	20561-6	Karton á 50 Stk. box á 50 pcs.	
vernickelt nickel plated	20565-4	Karton á 50 Stk. box á 50 pcs.	

Unterlegscheibe für Teppichschraube

washer for carpet screw



Messing brass	20563-0	SB-Beutel á 10 Stk. self-service bag á 10 pcs.	
	20564-7	Karton á 50 Stk. box á 50 pcs.	
vernickelt nickel plated	20566-1	Karton á 50 Stk. box á 50 pcs.	

69 Teppichnagel

carpet nail



messingfarben 3,0 x 30 brass coloured 3,0 x 30	20574-6	SB-Beutel á 10 Stk. self-service bag á 10 pcs.	
	20570-8	Karton á 100 Stk. box á 100 pcs.	
vernickelt 3,0 x 30 nickel plated 3,0 x 30	20582-1	SB-Beutel á 10 Stk. self-service bag á 10 pcs.	
	20578-4	Karton á 100 Stk. box á 100 pcs.	

Dreikantläuferstange 16 x 16 mm

triangular stair rod 16 x 16 mm

Material/material	L/(m)	Art./ref.	€
-------------------	-------	-----------	---

70 Dreikantläuferstange 16 x 16 mm / triangular stair rod 16 x 16 mm



Brünier-Farbton kann variieren
 colour of burnished brass can vary

Eisenrohr mit nahtlosem Messing-Überzug, poliert, lackiert steel pipe, brass plated, polished, painted	1,0	05003-2	
	2,5	05000-1	
vernickelt nickel plated	1,0	05002-5	
	2,5	05001-8	
brüniert burnished brass	1,0	05006-3	
	2,5	05007-0	

Nicht für den Außenbereich geeignet / not suitable for outdoor use

Zubehör für Dreikantläuferstange 16 x 16 mm

accessories for triangular stair rod 16 x 16 mm

Material/material	L/(m)	Art./ref.	€
-------------------	-------	-----------	---

180 Dreikantklappösen 16 x 16 mm, geschlossen / triangular folding eyelets 16 x 16 mm, closed

inkl. Dübel und Schrauben
 incl. screws + dowels



Messing, poliert, lackiert brass, polished, painted	05020-9	1 Paar / pair	
vernickelt nickel plated	05021-6	1 Paar / pair	
brüniert burnished brass	05022-3	1 Paar / pair	

Brünier-Farbton kann variieren / colour of burnished brass can vary

Achtung: Der Aufpreis für die Anfertigung von Sonderlängen beträgt 15% zuzügl. Verschnitt!
 Note: There is a 15% surcharge for special length cuts plus waste!

Der Läuferstangendurchmesser ist nach Läuferart und Verlegetechnik zu wählen! Wir beraten Sie gern!
 Stair rod diameter should be selected according to type of carpet and laying technology! We advise you gladly!

Läuferstange ø 16 mm			
stair rod ø 16 mm			
Material / material	L / l (m)	Art. / ref.	€

71 Messingläuferstange ø 16 x 3 mm Messing / stair rod ø 16 x 3 mm brass

poliert, lackiert, 3 mm Wandstärke, ohne Abschlussknöpfe
 polished, painted, 3 mm walls, without endings

1,0	05451-1	
-----	---------	--



Länge = Rohrlänge ohne Abschlussknöpfe
 length = pipe length without endings

Die Fertigung erfolgt objektbezogen.
 Manufactured on customers order.

Abschlussknöpfe für Messingläuferstangen ø 16 x 3 mm / endings for 16 x 3 mm brass stair rods

Messing gedreht, poliert, lackiert
 brass twisted, polished, painted

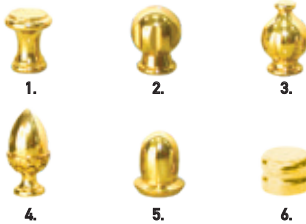

1. Knaufform knob shape		05801-4	
2. Kronenform crown shape		05802-1	
3. Zepterform scepter shape		05803-8	
4. Imperial imperial shape		05806-9	
5. Eichelform oak shape		05804-5	
6. Zylinderform cylinder shape		05805-2	

72 Läuferstange ø 16 x 1 mm Edelstahl matt / stair rod ø 16 x 1 mm stainless steel matt



ohne Abschlussknöpfe
 without endings

Länge = Rohrlänge ohne
 Abschlussknöpfe
 length = pipe length without endings

0,75	38930-9	
0,8	38940-8	
0,9	38950-7	
1,0	05015-5	
1,1	38960-6	
1,2	38970-5	
1,3	38980-4	

194 Läuferstange ø 16 x 2 mm Edelstahl matt / stair rod ø 16 x 2 mm stainless steel matt



ohne Abschlussknöpfe
 without endings

Länge = Rohrlänge ohne
 Abschlussknöpfe
 length = pipe length without endings

1,0	05014-8	
1,5	38990-3	
2,0	39000-8	

Abschlussknopf Zylinderform für Edelstahl-Läuferstangen 16 x 1 und 16 x 2 mm

endings cylinder shape for stainless
 steel stair rod 16 x 1 and 16 x 2 mm



vernickelt nickelt plated	05016-2	
vernickelt matt nickelt plated matt	39010-7	



Zubehör für Läuferstange ø 16 mm

accessories for stair rod ø 16 mm

Material/material	Verpackung/unit	Art./ref.	€
-------------------	-----------------	-----------	---

182 Kugelöse für Läuferstange ø 16 mm, gedreht / ball eyelet for stair rod ø 16 mm, twisted

gedrehte Ausführung mit Stockschraube M5 x 30 für stabilere Befestigung

twisted execution with hanger bolt M5 x 30 for stronger fixing



Feststellschraube
locking screw

Messing, poliert, lackiert brass, polished, painted	1 Stück / pcs.	05826-7	
Messing mit Feststellschraube brass with locking screw	1 Stück / pcs.	05827-4	
vernickelt nickel plated	1 Stück / pcs.	05828-1	
vernickelt mit Feststellschraube nickel plated with locking screw	1 Stück / pcs.	05829-8	
vernickelt matt nickel plated matt	1 Stück / pcs.	39020-6	
vernickelt matt mit Feststellschraube nickel plated mat with locking screw	1 Stück / pcs.	39030-5	

Kugelöse für Läuferstange ø 16 mm, gegossen / ball eyelet for stair rod ø 16 mm, casted

Stockschraube 4 x 20
hanger bolt 4 x 20

Messing, poliert, lackiert brass, polished, painted	1 Stück / pcs.	05811-3	
vernickelt nickel plated	1 Stück / pcs.	05812-0	

Eindrehwerkzeug für Kugelösen 16 mm, Messing / tool for ball eyelets 16 mm, brass

zur Verwendung im Akkuschauber/
for use in electric drills

72256-4

183 Klappöse große Ausführung ø 16 mm, offen / folding eyelets large ø 16 mm, open

inkl. Schrauben & Dübel
incl. screws + dowels



Messing, glatt brass, smooth	1 Paar / pair	05510-5	
Messing mit Dekor brass with decor	1 Paar / pair	05530-3	
vernickelt glatt nickel plated smooth	1 Paar / pair	05520-4	
vernickelt mit Dekor nickel plated with decor	1 Paar / pair	05540-2	
vernickelt matt glatt nickel plated smooth	1 Paar / pair	39040-4	
vernickelt matt mit Dekor nickel plated with decor	1 Paar / pair	39050-3	

434 Klappöse große Ausführung ø 16 mm, geschlossen / folding eyelets large ø 16 mm, closed

inkl. Schrauben & Dübel
incl. screws + dowels



Messing glatt brass smooth	1 Paar / pair	39060-2	
Messing mit Dekor brass with decor	1 Paar / pair	39070-1	
vernickelt glatt nickel plated smooth	1 Paar / pair	39065-7	
vernickelt matt glatt nickel plated mat smooth	1 Paar / pair.	39075-6	

Achtung: Der Aufpreis für die Anfertigung von Sonderlängen beträgt 15% zuzügl. Verschnitt!
 Note: There is a 15% surcharge for special length cuts plus waste!

Der Läuferstangendurchmesser ist nach Läuferart und Verlegetechnik zu wählen! Wir beraten Sie gern!
 Stair rod diameter should be selected according to type of carpet and laying technology! We advise you gladly!

Läuferstange ø 25 mm			
stair rod ø 25 mm			
Material / material	L / l (m)	Art. / ref.	€

184 Läuferstange ø 25 x 4 mm, Messing / stair rod ø 25 x 4 mm brass

4 mm Wandstärke / 4 mm walls



Messing, poliert, lackiert brass, polished, painted	1,0	39250-7	
--	-----	---------	--

Die Fertigung erfolgt objektbezogen / manufactured on customers order

187 Abschlussknopf Imperial 25 mm / endings imperial 25 mm



Messing, poliert, lackiert brass, polished, painted		39266-8	
--	--	---------	--

185 Profi-Kugelöse 25 mm, gedreht / profi-ball eyelet 25 mm, twisted

gedrehte Ausführung mit Stockschraube M 6 x 50 für stabilere Befestigung

twisted version with hanger bolt M6 x 50 for stronger fastening



Messing, poliert, lackiert brass, polished, painted		39262-0	
--	--	---------	--

mit Feststellschraube with locking screw		39264-4	
---	--	---------	--

186 Klappöse ø 25 mm, große Ausführung / folding eyelets large ø 25 mm

inkl. Schrauben & Dübel
incl. screws + dowels



Messing, poliert, lackiert, offen, mit Dekor brass polished, painted, open, with decor		39260-6	
---	--	---------	--

Für Läuferbreiten bis 2,9 m ohne Mittelöse im hochwertigen Objektbereich
 for carpets with a width of 2,9 m without middle fixings in grand buildings



Staatstheater Warschau
state theatre Warsaw



11. Reparaturwinkel für Treppen und PVC-Profile

11. repair angles for stairs + PVC profiles

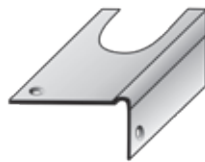

11



Extra Schrauben + Dübel siehe Abschnitt 12! / Extra screws + dowels see section 12!

Reparaturwinkel Edelstahl für Treppensanierung					
repair angle steel stainless steel for staircase renovation					
Material/material	Art./ref.	L/l (m)	Stk./VE/pcs/unit	€/Stk./pcs.	

336 EDELSTAHL – Reparaturwinkel B 20 für Betontreppen

stainless steel repair angle B20 for concrete stairs

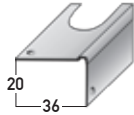

20 mm Nase nose	ohne Befestigungszubehör without fixing accessories	00973-3	1,0	25	
		00982-1	1,25		
		00975-1	2,0		

Extra Befestigungszubehör siehe Abschnitt 12!
Extra fixing accessories, see section 12!

Reparaturwinkel Stahl verzinkt für Treppensanierung					
repair angle steel galvanized for staircase renovation					
Material/material	Art./ref.	L/l (m)	Stk./VE/pcs/unit	€/Stk./pcs.	

243 Reparaturwinkel H 15 für Holztreppen

repair angle H15 for wooden stairs

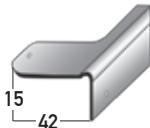

15 mm Nase nose	inkl. Ringnägel incl. ruffled nails	00942-9	1,0	25	
		00943-6	2,0		
	ohne Befestigungszubehör without fixing accessories	00950-4	1,0	25	
		00951-1	2,0		

119 Reparaturwinkel H 20 für Holztreppen

repair angle H20 for wooden stairs

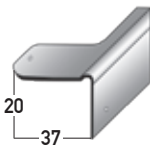

20 mm Nase nose	inkl. Ringnägel incl. ruffled nails	00910-8	1,0	25	
		00983-0	1,25		
		00915-3	2,0		
	ohne Befestigungszubehör without fixing accessories	00955-9	1,0	25	
		00984-9	1,25		
		00957-3	2,0		

242 Reparaturwinkel H 38 für Holztreppen

repair angle H38 for wooden stairs

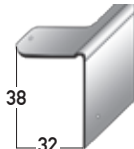

38 mm Nase nose	inkl. Ringnägel incl. ruffled nails	00920-7	1,0	25	
		00925-2	2,0		
	ohne Befestigungszubehör without fixing accessories	00960-3	1,0	25	
		00961-0	2,0		

244 Reparaturwinkel B 15 für Betontreppen

repair angle B15 for concrete stairs

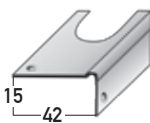

15 mm Nase nose	inkl. Schrauben + Dübel incl. screws + dowels	00945-0	1,0	25	
		00946-7	2,0		
	ohne Befestigungszubehör without fixing accessories	00965-8	1,0	25	
		00966-5	2,0		

120 Reparaturwinkel B 20 für Betontreppen

repair angle B20 for concrete stairs

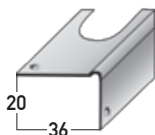

20 mm Nase nose	inkl. Schrauben + Dübel incl. screws + dowels	00930-6	1,0	25	
		00985-8	1,25		
		00935-1	2,0		
	ohne Befestigungszubehör without fixing accessories	00970-2	1,0	25	
		00986-7	1,25		
		00972-6	2,0		

432 RUND-Reparaturwinkel B 25 x 40, R 7,5 für DEBOLON-TK 3

round repair angle B25x40 R 7,5 for Debolon-TK 3

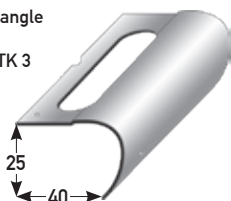

25 mm Nase nose	inkl. Schrauben + Dübel incl. screws + dowels	00979-7	1,0	25	
		00987-6	1,25		
		00981-2	2,0		
	ohne Befestigungszubehör without fixing accessories	00976-0	1,0	25	
		00988-5	1,25		
		00978-8	2,0		

PVC-Profil					
PVC-profiles					
Material / material	Stück / VE pcs / unit	L / l (m)	Farbe / colour	Art. / ref.	€/Stk. / pcs.

356 PVC-Einfassleiste, einseitig

PVC insert profile, single-sided

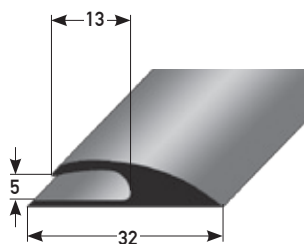

einseitig, ohne Kleber weich PVC für Beläge bis 5 mm single sided, without adhesive, soft PVC, for floorings up to 5 mm	20	2.7	grau grey	52848-7	
			schwarz black	52850-0	
			braun brown	52852-4	
			beige beige	52854-8	

357 PVC-Einfassleiste, doppelseitig

PVC insert profile, double-sided

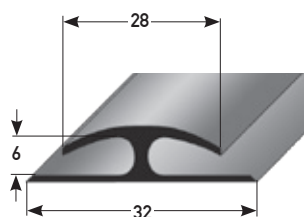

doppelseitig, ohne Kleber weich PVC für Beläge bis 6 mm double, without adhesive, soft PVC, for floorings up to 6 mm	20	2.7	grau grey	52856-2	
			schwarz black	52858-6	
			braun brown	52860-9	
			beige beige	52862-3	

358 PVC-Übergangprofil 30 mm

PVC connecting profile 30 mm

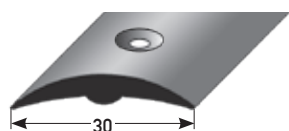

hart PVC, gelocht hard PVC, drilled	20	1.0	grau grey	52864-7	
			braun brown	52866-1	
			beige beige	52868-5	

246 PVC-Winkel für Stufenmatten, selbstklebend

PVC angle for stair mats, self adhesive

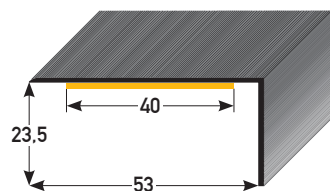

23.5 x 53 mm, Oberfläche geriffelt 40 mm Kleberbreite 23.5 x 53 mm, ribbed surface, 40 mm adhesive width	10	0.63	unbestimmt Recyclingmaterial indefinite, recycled material	52101-3	
		2.7		52102-0	



PVC-Profil					
PVC-profiles					
Material/ material	Stück/VE pcs/ unit	L/ l (m)	Farbe/ colour	Art./ ref.	€

51 PVC-Knickwinkel 20 x 20 mm

PVC bending angle 20 x 20 mm

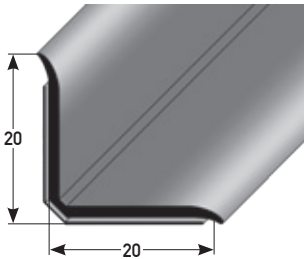

selbstklebend weich PVC auf Rolle self-adhesive soft PVC rolled	4	Rolle/ roll à 25 m	grau/ grey	57301-2	
			braun/ brown	57303-6	
			beige/ beige	57304-3	
			weiß/ white	57308-1	
			Eiche hell oak light	57305-0	

57 PVC-Sockelleisten 15 x 50 mm

PVC skirting 15 x 50 mm

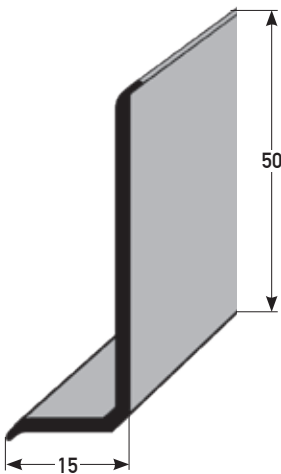

ohne Kleber weich PVC auf Rolle without adhesive soft PVC rolled	2	Rolle/ roll à 50 m	grau/ grey	58381-3	
			braun/ brown	58383-7	
			beige/ beige	58384-4	
			weiß/ white	58388-2	
			Eiche hell/ oak light	58385-1	
			Esche grau/ ash-tree-grey	58387-5	
			Buche/ beech	58389-9	
Ahorn/ maple	58420-9				

Verlegehinweis!

Behandeln Sie raue und saugende Untergründe mit Grundierung nach Herstellervorschrift vor. Fettige Stellen müssen entfettet bzw. isoliert werden.

Installation tip!

Treat rough and absorbent surfaces with primer. Follow the manufacturers directions. Greasy surfaces need to be degreased before installation.

433 PVC-Hohlkehldprofil 25 x 25 mm als Stützunterlage für Bodenbelagssockel

PVC hollow profile 25 x 25 mm
as floor to wall support

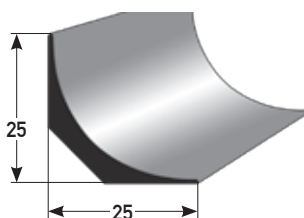

für einen optimalen Übergang der Bodenbeläge vom Boden zur Wand
for best edge linking carpets from floor to wall.



PVC-Treppenkanten

PVC stair nosings

Material/ material	L/ (m)	Stück/VE pcs/ unit	Farbe/ colour	Art./ ref.	€
--------------------	--------	--------------------	---------------	------------	---

361 PVC-Treppenkante 30 x 45 x 3 mm

PVC stair nosing 30 x 45 x 3 mm

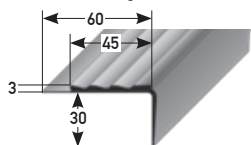

für Beläge bis 3 mm. weich PVC for floorings up to 3 mm. soft PVC	2,5	Karton/box à 30	grau/ grey	52800-5	
			schwarz/ black	52802-9	
			braun/ brown	52804-3	
			beige/ beige	52806-7	

362 PVC-Treppenkante 45 x 35 x 2 mm

PVC stair nosing 45 x 35 x 2 mm

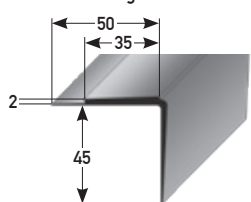

für Beläge bis 2 mm. weich PVC for floorings up to 2 mm. soft PVC	2,5	Karton/box à 30	grau/ grey	52808-1	
			schwarz/ black	52810-4	
			braun/ brown	52812-8	
			beige/ beige	52814-2	

363 PVC-Treppenkante 42 x 45 x 3 mm

PVC stair nosing 42 x 45 x 3 mm

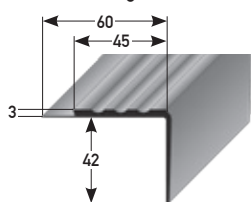

für Beläge bis 3 mm. weich PVC for floorings up to 3 mm. soft PVC	2,5	Karton/box à 25	grau/ grey	52816-6	
			schwarz/ black	52818-0	
			braun/ brown	52820-3	
			beige/ beige	52822-7	

364 PVC-Treppenkante 42 x 42 x 3 mm

PVC stair nosing 42 x 42 x 3 mm

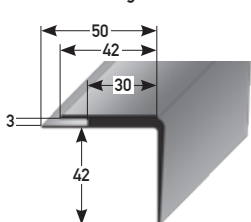

für Beläge bis 3 mm. weich PVC for floorings up to 3 mm. soft PVC	2,5	Karton/box à 20	grau/ grey	52824-1	
			schwarz/ black	52826-5	
			braun/ brown	52828-9	
			beige/ beige	52830-2	

366 PVC-Treppenkante 42 x 57 mm

PVC stair nosing 42 x 57 mm

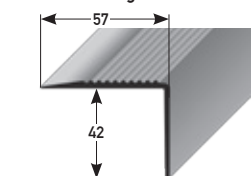

weich PVC soft PVC	2,5	Karton/box à 30	grau/ grey	52840-1	
			schwarz/ black	52842-5	
			braun/ brown	52844-9	
			beige/ beige	52846-3	

12. Zubehör

12. accessories

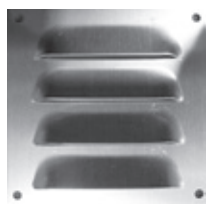
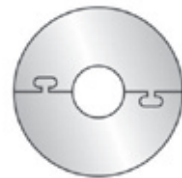

12. ZUBEHÖR / 12. ACCESSORIES

Achtung! Bitte beachten Sie die Verlegehinweise in Abschnitt 13.
Attention! Please note the installation tips on section 13.

Klebezubehör / adhesive accessories

Breite / width (mm)	Länge / length (m) Rolle / roll á	Art. / ref.	€/Rolle / roll
---------------------	--------------------------------------	-------------	----------------

Spezialverlegeband 50 mm

special tape 50 mm

50 mm	25 m	15024-4	
-------	------	---------	--

beidseitig klebender Acrylatkleber mit Gewebeträger, weitgehend weichmacherbeständig
double-sided acrylat adhesive with fabric support, mostly plasticizer-resistant

Verlegeband super 35 mm

tape super 35 mm

35 mm	50 m	15026-8	
-------	------	---------	--

beidseitig klebend, extreme Klebkraft, z. B. für Sockelleisten
double-sided extremely strong, e. g. for skirtings

Verlegeband

tape

45 mm	50 m	15030-5	
-------	------	---------	--

beidseitig klebend z. B. für Sockelleisten
double sided for e. g. for skirtings

Flachklebeband 22 mm

flat tape 22 mm



22 mm	100 m	15040-4	
-------	-------	---------	--

beidseitig klebend für Metallprofile, 1 Klebstoffstreifen 18 mm breit, 0,4 mm dick, auf Basis Synthesekautschuk
double-sided for metall profiles, 1 adhesive strip 18 mm wide, 0.4 mm thick, based on synthetic rubber

Flachschnurklebeband 27 mm

flat corded tape 27 mm

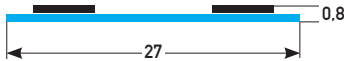

27 mm	250 m	15062-6	
-------	-------	---------	--

beidseitig klebend für Metallprofile, 2 Klebstoffstreifen, 6 mm breit, 0,8 mm dick
double-sided for metall profiles, 2 adhesive strips, 6 mm wide, 0.8 mm thick

Rundschnurklebeband 28 mm

corded tape 28 mm

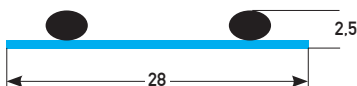

28 mm	100 m	15052-7	
-------	-------	---------	--

beidseitig klebend für Metallprofile, 2 Klebstoffstreifen, 2,5 mm Durchmesser
double-sided for metall profiles, 2 adhesive strips, 2.5 mm diameter

Grundierung für Metallprofile

primer for metall profiles



Art. / ref.	€/Stk. / pcs.
71956-4	auf Anfrage

Für die Klebmontage empfehlen wir die Verwendung eines geeigneten Primers.
Gerne beraten wir Sie dahingehend.

We recommend using a suitable primer for adhesive mounting.
We would be happy to advise you on this.

Montagekleber (Basis MSX-Polymer)

installation glue (based on MSX polymer)

Art. / ref.	€/Stk. / pcs.
22245-3	

Kartusche „FIX ALL FLEXI“ 470 g, weiß
cartridge „FIX ALL FLEXI“ 470 g, white

22257-6	
---------	--

Kartusche „FIX ALL CRISTAL“ 300 g, transparent
cartridge „FIX ALL CRISTAL“ 300 g, transparent



22258-3	
---------	--

Kartusche „FIX ALL TURBO“ 430 g, weiß
cartridge „FIX ALL TURBO“ 430 g, white



Spanplattenschrauben PZD 1 / TORX TX10

chipboard screws cross slot PZD 1 / TORX TX10

Größe / dimension	Material/Farbe material/colour	Btl./VE bags/unit	Stückzahl/ Beutel	 Linsenkopf/ button head		 Senkkopf/ countersunk head	
				Art./ref.	€/Btl./bag	Art./ref.	€/Btl./bag
3 x 20	Fe-Messing iron brass	30	50 SB	20031-4		20035-2	
		30	10 SB	20032-1		20036-9	
		30	100	20033-8		20037-6	
		6	500	20034-5		20038-3	
	Fe-Nickel iron nickel	30	50 SB	20041-3		20045-1	
		30	10 SB	20042-0		20046-8	
		30	100	20043-7		20047-5	
		6	500	20044-4		20048-2	
	Fe-bronze hell pulverbeschichtet bronze light powder coated	30	50 SB	16005-2		16025-0	
		30	10 SB	16010-6		16030-4	
		30	100	16015-1		16035-9	
		6	500	16020-5		16040-3	
Fe-bronze dunkel iron bronze dark	30	50 SB	20051-2		20055-0		
	30	10 SB	20052-9		20056-7		
	30	100	20053-6		20057-4		
	6	500	20054-3		20058-1		
3 x 25	Fe-Messing iron brass	30	50 SB	20065-9		20061-1	
		30	10 SB	20066-6		20062-8	
		30	100	20067-3		20063-5	
		6	500	20068-0		20064-2	
	Fe-Nickel iron nickel	30	50 SB	20075-8		20071-0	
		30	10 SB	20076-5		20072-7	
		30	100	20077-2		20073-4	
		6	500	20078-9		20074-1	
	Fe-bronze hell pulverbeschichtet bronze light powder coated	30	50 SB	16045-8		16065-6	
		30	10 SB	16050-2		16070-0	
		30	100	16055-7		16075-5	
		6	500	16060-1		16080-9	
Fe-bronze dunkel iron bronze dark	30	50 SB	20085-7		20081-9		
	30	10 SB	20086-4		20082-6		
	30	100	20087-1		20083-3		
	6	500	20088-8		20084-0		
3 x 30	Fe-Messing iron brass	30	50 SB	20091-8		20095-6	
		30	10 SB	20092-5		20096-3	
		30	100	20093-2		20097-0	
		6	500	20094-9		20098-7	
	Fe-Nickel iron nickel	30	50 SB	20101-4		20105-2	
		30	10 SB	20102-1		20106-9	
		30	100	20103-8		20107-6	
		6	500	20104-5		20108-3	
	Fe-bronze hell pulverbeschichtet bronze light powder coated	30	50 SB	16085-4		16105-9	
		30	10 SB	16090-8		16110-3	
		30	100	16095-3		16115-8	
		6	500	16100-4		16120-2	
Fe-bronze dunkel iron bronze dark	30	50 SB	20111-3		20115-1		
	30	10 SB	20112-0		20116-8		
	30	100	20113-7		20117-5		
	6	500	20114-4		20118-2		

Abpackungen à 500 Stück, sowohl im Beutel als auch im Karton erhältlich. Bitte bei der Bestellung angeben.
 Packs à 500 pcs. are available in bags and also in boxes. Please specify when you place your order.

Spanlattenschrauben, TORX TX10, Senkkopf

chipboard screws cross slot PZD 1/ TORX TX10

Abbildung illustration	Material/Farbe material/colour	Stückz./Btl. pcs./bag	Größe/dimension	Art./ref.	€/Btl./bag
	schwarz/black	Btl./bag à 100	3 x 20	72260-1	
			3 x 25	72262-5	
			3 x 30	72264-9	
	Fe-Nickel iron nickel	Btl./bag à 100	3,5 x 25	16000-7	
			3,5 x 30	16001-4	
			3,5 x 40	16002-1	

Emaille-beschichtete Schrauben, PZD 1/ TORX TX10, Senkkopf

enamel-coated screws PZD 1/ TORX TX10, countersunk head

Abbildung illustration	Material/Farbe material/colour	Stückz./Btl. pcs./bag	Größe/dimension	Art./ref.	€/Btl./bag
	dunkelgrau metallic/dark grey	Btl./bag à 100	3 x 25	40120-9	
	silber metallic/silver metallic			40270-1	

Profi-K-Spezialschraube, TX 10, Kopf 5,8 mm

professional-K screws 4 x 45, TX 10, head 5,8 mm

Abbildung illustration	Material/Farbe material/colour	Stückz./Btl. pcs./bag	Größe/dimension	Art./ref.	€/Btl./bag	
	Fe-Nickel iron-nickel	Btl./bag à 100	4x20	72516-9		
			4x25	72518-3		
			4x30	72520-6		
			4x35	72522-0		
	Fe-Messing iron brass		4x45	36640-9		
			Fe-bronze hell iron-bronze light	4x45	36630-0	
				4x45	36645-4	
			Fe-bronze dunkel iron-bronze dark	4x45	36650-8	

Edelstahlschrauben, Senkkopf, Kreuzschlitz, Beutel à 100 Stk.

stainless steel screw, countersunk head, cross slot, bag à 100 pcs.

Abbildung illustration	Größe/dimension	Art./ref.	€/100 Stk./pcs.	Art./ref.	€/100 Stk./pcs.
	3 x 20	39330-6		39360-3	
	3 x 25	39340-5		39365-8	
	3 x 30	39350-4		39370-2	
	4 x 40	39400-6		39380-1	
	4 x 45	39410-5		39390-0	
	4 x 50	39420-4			

Dübel

dowels

Abbildung illustration	Maß/size (mm)	Stk./Verpack. pcs./pack	Art./ref.	€/Btl./Kart. €/bag/box
	5 mm	Btl./bag à 20 SB	20151-9	
		Btl./bag à 100	20150-2	
		Btl./bag à 500	20160-1	
	6 mm	Btl./bag à 20 SB	20171-7	
		Btl./bag à 100	20170-0	
		Btl./bag à 500	20172-4	
	5 mm	Btl./bag à 100	20161-8	
	6 mm	Btl./bag à 100	20165-6	

Schrauben für Mini-APL- & SKD-System					
screws for MINI-APL + SKD -system					
		2,9 x 5,5 mm		2,9 x 9,0 mm	
Material / Farbe material / colour	Btl. / VE bags / unit	Art. / ref.	€/100 Stk. / pcs.	Art. / ref.	€/100 Stk. / pcs.
FE-verzinkt iron galvanized	1	20986-7		20991-1	
FE-vermessingt iron brass plated		20987-4		20992-8	
FE-bronze dunkel iron bronze dark		20988-1		20993-5	
FE-gelb verzinkt iron yellow galvanized		20989-8		20994-2	

Schrauben für APL- & SLP-System							
screws for APL + SLP-system							
		2,9 x 7 mm		2,9 x 11 mm		2,9 x 17 mm	
Material / Farbe material / colour	Btl. / VE bags / unit	Art. / ref.	€/100 Stk. / pcs.	Art. / ref.	€/100 Stk. / pcs.	Art. / ref.	€/100 Stk. / pcs.
FE-verzinkt iron galvanized	1	20971-3		70902-2		20981-2	
FE-vermessingt iron brass plated		20972-0		70904-6		20982-9	
FE-bronze dunkel iron bronze dark		20973-7		70906-0		20983-6	
FE-gelb verzinkt iron yellow galvanized		20974-4		70908-4		20984-3	

		2,9 x 7 mm		2,9 x 13 mm		2,9 x 17 mm	
Material / Farbe material / colour	Btl. / VE bags / unit	Art. / ref.	€/100 Stk. / pcs.	Art. / ref.	€/100 Stk. / pcs.	Art. / ref.	€/100 Stk. / pcs.
Edelstahl stainless steel	1	20975-1		70910-7		20985-0	

Extra Befestigungszubehör für Reparaturwinkel H15, H20, H38					
extra fixing accessories for repair angle H15, H20, H38					
	Maß / size (mm)	Material / Farbe material / colour	Stk. / Beutel pcs. / bag	Art. / ref.	€/Btl. / bags
Ringnägel rifled nails	2,2 / 2,4 x 27 mm	Fe-Nickel iron nickel plated	50	20181-6	
			100	20180-9	
			500	20182-3	
		Fe-Messing iron brass plated	50	20201-1	
			100	20200-4	
			500	20202-8	
		Fe-Bronze iron bronze plated	50	20211-0	
			100	20210-3	
			500	20212-7	

Wegmarkierungsronden aus 2 mm Edelstahl matt					
trail marker rondon out of 2 mm stainless steel matt					
	Durchmesser / diameter (mm)			Art. / ref.	€/Stk. / pcs.
Wegmarkierungsronden trail marker rondon	10			71400-2	
	15			71402-6	
	24			71404-0	



Leistenstifte

pins

Material / Farbe material / color	Maß / size (mm)	Stk. / Verpack. pcs. / pack	VE / unit	Art. / ref.	€ / Btl. / Kart. € / bag / box
--------------------------------------	--------------------	--------------------------------	-----------	----------------	-----------------------------------

1,5 mm Leistenstifte Stahl, gehärtet

1,5 mm pins steel, hardened



verzinkt galvanized	1,5 x 20	Karton à 1000 Stk. box à 1000 pcs.	5	20600-2	
	1,5 x 25			20610-1	
	1,5 x 30			20620-0	
	1,5 x 35			20630-9	
blank bare	1,5 x 20	Karton à 1000 Stk. box à 1000 pcs.	5	20640-8	
	1,5 x 25			20650-7	
	1,5 x 30			20660-6	
	1,5 x 35			20670-5	
vermessingt, lackiert brass plated, painted	1,5 x 25	Beutel à 100 Stk. bag à 100 pcs.	10	20680-4	
	1,5 x 30			20685-9	
	1,5 x 35			20690-3	
	1,5 x 25	Karton à 1000 Stk. box à 1000 pcs.	5	20681-1	
	1,5 x 30			20686-6	
	1,5 x 35			20691-0	

1,4 mm Leistenstifte Stahl, gehärtet

1,4 mm pins steel, hardened



mit geschlagener Spitze
für normale Beanspruchung
with hammered tip, for normal use

verzinkt galvanized	1,4 x 20	Kart. / box à 1000	5	20300-1	
		Btl. / bag à 1000	5	20302-5	
		Btl. / bag à 100	10	20301-8	
	1,4 x 25	Kart. / box à 1000	5	20350-6	
		Btl. / bag à 1000	5	20352-0	
		Btl. / bag à 100	10	20351-3	
	1,4 x 30	Kart. / box à 1000	5	20400-8	
		Btl. / bag à 1000	5	20402-2	
		Btl. / bag à 100	10	20401-5	
1,4 x 35	Kart. / box à 1000	5	20450-3		
	Btl. / bag à 1000	5	20452-7		
	Btl. / bag à 100	10	20451-0		

„ELOXAL-FIX“ Schleifreiniger, mittel, mit Körnung 120

zur Beseitigung von leichten Oberflächenverunreinigungen eloxierter Profile
(nicht geeignet für eine durchbrochene Eloxalschicht)

Art./ref.	€/Stk./pcs.
22281-1	

„ELOXAL-FIX“ cleaning block,
medium, with grain size 120 for
removing facile surface
contaminants at anodized profiles
(not suitable for a perforated
anodized coating)



Andere Abmaße auf Anfrage
Other dimensions on request.

Türstopper

door stopper

Maß / size (mm)	Stück / Verpack. pcs. / pack	VE unit	Art. / ref.	€ / Stk. / pcs.
-----------------	------------------------------	---------	-------------	-----------------

249 hochwertiger Türstopper für Wandmontage

high quality door stopper for wall installation

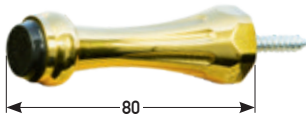
 Gesamttiefe **80 mm**, Schlüsselweite 24 mm / depth: 80 mm wrench opening: 24 mm

Messing brass	Karton à 10 Stück / box à 10 pcs.	1 Kart. / box	20598-2	
	SB-Beutel à 1 Stk. bag à 1 pcs.	10 St. / pcs	20599-9	
vernickelt nickel plated	Karton à 10 Stück / box à 10 pcs.	1 Kart. / box	20360-5	
	SB-Beutel à 1 Stk. bag à 1 pcs.	10 St. / pcs	20361-2	

79 hochwertiger Türstopper montagefertig

high quality door stopper

 Gesamthöhe **35 mm**, Durchmesser 28 mm / height 35 mm, diameter 28 mm

Messing brass	Karton à 10 Stück / box à 10 pcs.	1 Kart. / box	20590-6	
	SB-Beutel à 1 Stk. bag à 1 pcs.	10 St. / pcs	20592-0	
vernickelt nickel plated	Karton à 10 Stück / box à 10 pcs.	1 Kart. / box	20591-3	
	SB-Beutel à 1 Stk. bag à 1 pcs.	10 St. / pcs	20593-7	

248 Türstopper schwere Ausführung

door stopper, heavy

 Gesamthöhe **44 mm**
Durchmesser 38 mm
height 44 mm, diameter 38 mm

Messing brass	Karton à 10 Stück / box à 10 pcs.	1 Kart. / box	20594-4	
	SB-Beutel à 1 Stk. bag à 1 pcs.	10 St. / pcs	20596-8	
vernickelt nickel plated	Karton à 10 Stück / box à 10 pcs.	1 Kart. / box	20595-1	
	SB-Beutel à 1 Stk. bag à 1 pcs.	10 St. / pcs	20597-5	

 andere Abmessungen auf Anfrage
other dimensions on demand

Heizrohrrosetten aus 3 mm Edelstahl matt

heating pipe rosettes, 3 mm stainless steel matt

		A x B x C (mm)		Art. / ref.	€/Stück / pcs.
278 Heizrohrrosette Komplettkreis heating pipe rosette full circle		50 x 12 mm		14400-7	
		50 x 15 mm		14402-1	
		50 x 18 mm		14404-5	
		50 x 22 mm		14406-9	
279 Heizrohrrosette mit Wandteil heating pipe rosette with wall trim		50 x 12 mm		14416-8	
		50 x 15 mm		14418-2	
		50 x 18 mm		14420-5	
		50 x 22 mm		14422-9	
280 Zwischenstück kombinierbar, für Doppelrohre insert pieces, for combination for double pipes		50 x 12 x 50 mm		14408-3	
		50 x 15 x 50 mm		14410-6	
		50 x 18 x 50 mm		14412-0	
		50 x 22 x 50 mm		14414-4	

C = Abstand der Heizrohre / distance between heating pipes

Lüftungsbleche aus Aluminium

aluminum vents

* Auslaufartikel / discontinued item

Lüftungsblech / vents

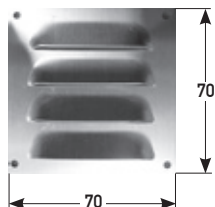

70 x 70 mm

110 x 110 mm

150 x 150 mm

Farbe / colour	VE / unit	Art. / ref.	€/St. / pcs.	SB-Verpackung / self-service pack			€ Beutel / bag
				VE / unit	St. / Btl. / pcs. / bag	Art. / ref.	
silberfarbig eloxiert silver anodized	25	21013-9		10 Btl. / bag	à 2 St. / pcs.	21014-6	
					à 4 St. / pcs.	21015-3	
					à 2 St. / pcs.	21001-6	
goldfarbig eloxiert gold anodized		21000-9		à 4 St. / pcs.	21002-3		
weiß, PVC-beschichtet white, PVC-coated		21025-2		à 2 St. / pcs.	21026-9		
				à 4 St. / pcs.	21027-6		
weiß, PVC-beschichtet white, PVC-coated	10	21305-5					
Kupfer antik PVC-beschichtet* antique copper, PVC-coated		21300-0*					
weiß, PVC-beschichtet white, PVC-coated	10	21315-4					
Kupfer antik PVC-beschichtet* antique copper, PVC-coated		21310-9*					

Lüftungsblech / vents ø 70 mm

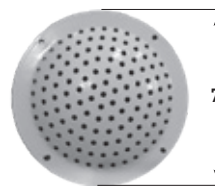

silberfarbig eloxiert silver anodized	25	21070-2		10 Btl. / bag	à 2 St. / pcs.	21071-9	
					à 4 St. / pcs.	21072-6	
					à 2 St. / pcs.	21051-1	
goldfarbig eloxiert gold anodized		21050-4		à 4 St. / pcs.	21052-8		
weiß, PVC-beschichtet white, PVC-coated		21056-6		à 2 St. / pcs.	21057-3		
				à 4 St. / pcs.	21058-0		
Kupfer antik PVC-beschichtet* antique copper, PVC-coated		21053-5*		à 2 St. / pcs.	21054-2*		
				à 4 St. / pcs.	21055-9*		

Lüftungsblech / vents ø 60 mm

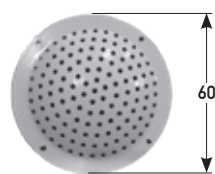

silberfarbig eloxiert silver anodized	25	21063-4		10 Btl. / bag	à 2 St. / pcs.	21064-1	
					à 4 St. / pcs.	21065-8	
					à 2 St. / pcs.	21061-0	
goldfarbig eloxiert gold anodized		21060-3		à 4 St. / pcs.	21062-7		
weiß, PVC-beschichtet white, PVC-coated		21040-5		à 2 St. / pcs.	21041-2		
				à 4 St. / pcs.	21042-9		
Kupfer antik PVC-beschichtet* antique copper, PVC-coated		21043-6*		à 2 St. / pcs.	21044-3*		
				à 4 St. / pcs.	21045-0*		

Lüftungsblech / vents ø 50 mm

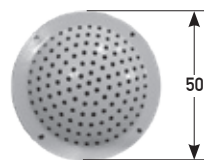

silberfarbig eloxiert silver anodized	25	21073-3		10 Btl. / bag	à 2 St. / pcs.	21074-0	
					à 4 St. / pcs.	21075-7	
					à 2 St. / pcs.	21031-3	
goldfarbig eloxiert gold anodized		21030-6		à 4 St. / pcs.	21032-0		
weiß, PVC-beschichtet white, PVC-coated		21036-8		à 2 St. / pcs.	21037-5		
				à 4 St. / pcs.	21038-2		
Kupfer antik PVC-beschichtet* antique copper, PVC-coated		21033-7*		à 2 St. / pcs.	21034-4*		
				à 4 St. / pcs.	21035-1*		

Lüftungsblech / vents 60 x 200 mm

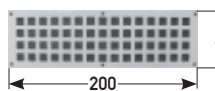

weiß, PVC-beschichtet white, PVC-coated	25	21190-7		10 Btl. / bag	à 2 St. / pcs.	21201-0	
--	----	---------	--	---------------	----------------	---------	--

Lüftungsblech / vents 60 x 400 mm

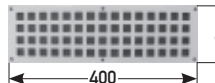

weiß, PVC-beschichtet white, PVC-coated	25	21240-9		10 Btl. / bag	à 2 St. / pcs.	21241-6	
--	----	---------	--	---------------	----------------	---------	--

13. Hinweise und AGB

13. hints + terms and conditions



Verlegehinweise

1. Für Edelstahlprodukte Unser Produkte werden, wenn nichts anderes angegeben ist, aus Edelstahl Werkstoff 1.4016 (poliert) und 1.4301(V2A) für den chemisch nicht belasteten Innen- und Außenbereich hergestellt. Für chemisch belastete Bereiche können wir auf Anfrage die Produkte auch aus V4A Werkstoff 1.4571 fertigen.

2 Für die Klebemontage Für die Klebemontage empfehlen wir die Verwendung eines geeigneten Primers. Gerne beraten wir Sie dahingehend.

3. Für Klebebänder Der Untergrund muss fest, trocken, staub- und fettfrei sein! Alle Klebebänder sind besonders umweltfreundlich, da lösungsmittelfrei!

Spezialverlegeband: als Untergrund eignen sich alle Flächen mit glatten, festen Oberflächen wie Gips, Keramik, Metall, Holz sowie festhaftende Tapete oder Farbanstrich

Verlegeband Super: speziell für rauhe, poröse Oberflächen wie Mauerwerk, Beton oder Putz (sofern nicht absandend)

4. Für selbstklebende Produkte

Der Untergrund muss trocken, staub- und fettfrei, sowie gerade und tragfähig sein, um einen Klebekontakt von 100% zu erreichen. Ungeübte sollten vorab das Profil mit Trägerpapier mehrfach trocken auflegen.

Notfalls Richtmarkierungen oder Anschläge verwenden, da die Profile in der Regel nur ein Mal verklebt werden können.

Bei Temperaturen über 80°C wird der Kleber stark elastisch bis flüssig. Klebereste kann man mit Nitroverdünnung entfernen.

Trägerpapier nun abziehen und aufkleben, dabei Klebebahn nicht mit Fingern berühren.

Verschiedene Faktoren können abstoßend wirken, wie z.B. Zementschleier, Teppichimprägnierung, Bodenbelagspflege, ausdünstende Beschichtungen, Restfeuchte.

Bitte Informationen beim jeweiligen Materiallieferanten einholen.

Bei Einsatz von Wölbprofilen im Fussboden + Objektbelastung kann es zum sogen. „Walkereffekt“ kommen.

Gibt das Profil beim Betreten in der Mitte nach unten nach (Kleber wird gewalzt), wird durch die Wölbung bedingte Steifheit des Profils eine Hebelwirkung an den äusseren Enden nach oben erzeugt. Staub unterwandert den Kleber.

Aufgrund dessen sollten die Profile **bauseits zusätzlich seitlich mit Montagekleber „Fix All“ Art.-Nr. 22245-3 fixiert** werden.

Der „Walkereffekt“ betrifft auch Treppenkanten. Der Einsatz von Selbstklebeband wird hier nicht empfohlen.

Der Kleber bleibt dauerelastisch (wie bei Dehnungsfugen), ist aber für Verklebung unter Decken geeignet.

Senkrechte Wandverklebungen, sowie Sockelleisten müssen mit „Fix All“ Montagekleber gesichert werden.

Achtung: Viele Wandoberflächen sind abweisend!

Bitte Informationen beim jeweiligen Materiallieferanten einholen.

Der Einsatz von selbstklebenden Produkten bei Brandschutztüren unterliegt der Genehmigung durch den Türenhersteller (Gewährleistungsfrage).

Die Klebkraft kann beträchtlich erhöht werden, wenn Profil und Untergrund mit Heißluft erwärmt werden.

5. Für Gleitschutzeinlagen

Einlage 12/23/39 / 50 mm breit, selbstklebend

Die Klebenut der Treppenkantenprofile trocken, staub- und fettfrei machen (Richtlinien f. Selbstklebeprodukte).

Die Einlagen entsprechend der Profillänge ausrollen und vorschneiden. Schutzfolie nach und nach abziehen und Einlage mit Andrückrolle fest anpressen. Der Kleber der Gleitschutzeinlage hat nach

24 Stunden seine volle Klebkraft erreicht. Die Gleitschutzeinlage beim Verlegen nicht dehnen.

Den Überstand nicht abschneiden, da sich das Band auf die vorgeschchnittene Länge wieder zusammenzieht.

Reinigungsmittel, die den Kleber auflösen, sind nicht zu verwenden.

Einlage 27 mm breit, eben oder gerippt für Kombi-Winkel

Die Einlagen entsprechend der Profillänge ausrollen und vorschneiden.

Nun an das Profil anlegen und zentimeterweise eindrücken. Dabei nicht dehnen.

Es ist mit einer Einlagenstreckung zu rechnen. Die Einlage schrumpft nach einer gewissen Zeit in die vorgeschchnittene Länge zurück.

Bei sofortiger maßlicher Fertigstellung, besonders bei Gehrungsschnitten, ca. 50 mm der **beiden Enden (rechts und links) mit Sekunden- oder Kontaktkleber (PVC-P / Metall) fixieren.**

Gelegentliches Wechseln der Einlagen, je nach Verschleißgrad, sollte vorgesehen werden.

Installation tips

1. For stainless steel

Unless otherwise stated, our products are made of stainless steel material 1.4016 (polished) and 1.4301 (V2A) for interior and exterior areas that are not exposed to chemical loads. For chemically contaminated areas, we can also manufacture the products from V4A material 1.4571 on request.

2. For adhesive assembly

We recommend using a suitable primer for adhesive mounting. We would be happy to advise you on this.

3. For adhesive tapes

The surface should be strong, dry, free of dust and any grease!

Special tape:

suitable surfaces include smooth dry surfaces such as plaster, ceramic, metal, wood as well as glued wallpaper and painted walls

Tape super:

especially suitable for rough and porous surfaces such as bricks and concrete

All adhesive tapes are environmentally friendly as they do not contain solvents!

4. For all self-adhesive products

The surface should be dry, free of dust and grease as well as straight and stable in order to achieve 100 % adhesive contact. If you are not experienced, try profiles with the protective film.

Use markings or other tools to help. Profiles usually can only be glued once.

At temperatures above 80 °C the adhesive becomes very elastic and liquid.

Use nitro thinner to remove any adhesive leftovers.

Remove protective film and stick the profiles into position, without touching the adhesive surface.

Some factors can influence the strength of the adhesive bond: e.g. cement residue, carpet impregnation, vapours of coatings, humidity. For more information please ask the supplier.

The use of some profiles and heavy usage can lead to a „bulging effect“.

If the profile is bent down slightly by stepping on it in the middle, the adhesive is „walked“.

The outside edges of the profile are lifted slightly and dust can get on the adhesive

leaving the adhesive much less effective. [Fix the profiles laterally with installation glue to prevent this.](#)

„Fix All“ Ref-no. 22245-3. The „bulging effect“ may also occur with stair nosings, but the use of self-adhesive tape is not recommended here. Although the glue stays elastic, its use is not recommended under ceilings.

Vertical installations need to be secured with „Fix All“ installation glue. Attention: Many wall surfaces do not bond!

For more information please ask the supplier.

For usage involving fire doors it is required to get a prior permission by the manufacturer.

The adhesive strength can be substantially increased, if the profiles or surface is warmed with hot air.

5. For anti-slip inserts

[Insert 12/23/39/50 mm wide, self-adhesive](#)

The adhesive seam of the profiles needs to be free of dust, dirt and grease. Roll out the insert according to the profile's length and cut bit by bit. Remove the protective film and push the insert tightly on the profile with a roll. The adhesive will have reached its full strength after 24 h.

Do neither stretch the insert during installation nor cut any surplus length of the insert.

It will revert back to its original size after some time.

Do not use any cleaning agents, which dissolve the adhesive.

[PVC insert 27 mm wide, smooth or ribbed for combination stair nosing](#)

Roll out the inserts according to the length of the profiles and cut insert into the profile by pushing in 5 cm at a time, do not stretch the insert! Otherwise, it will revert back to its original length after some time.

After installing the insert, but especially when mitre cuts were used, [fix the ends of the inserts \(5 cm\) with contact adhesive or superglue](#). Please expect to change the inserts occasionally, depending on usage.



Liefer- und Zahlungsbedingungen

1. Allgemeine Produktbeschreibungen, Zeichnungen, Muster, Abbildungen und Maße sind unverbindlich. Die Angaben sind daher nur nach schriftlicher Bestätigung verbindlich. Dies betrifft auch Auskünfte, Ratschläge und Empfehlungen unserer Mitarbeiter. Produktionsbedingte Farbabweichungen, Konstruktions- oder Formänderungen bleiben unter Vorbehalt, sofern keine erheblichen Änderungen des Kaufgegenstandes entstehen.
2. Allen Lieferungen werden die z.Zt. der Lieferung geltenden Preise und Rabatte zugrunde gelegt. Der Käufer erkennt die vorliegenden Verkaufsbedingungen als verbindlich an.
3. Der Versand von Lagerware innerhalb Deutschlands erfolgt in der Regel innerhalb von 7 Werktagen (nach Vereinbarung auch kurzfristiger, Expresskosten werden vom Kunden getragen). Transportkosten und Lieferzeiten für Inselzustellungen sind separat zu erfragen. Der Besteller hat bei Versendung der Ware an den von ihm benannten Bestimmungsort, im Rahmen seiner Mitwirkungspflicht, die erforderlichen Voraussetzungen für die Entgegennahme der Ware bei Anlieferung vor Ort zu schaffen. Das von uns beauftragte Liefer- / Zustellungsunternehmen ist nicht verpflichtet, am jeweiligen Bestimmungsort in unzumutbarer Weise nach dem Empfänger zu forschen. Kann die Ware nicht termingemäß zugestellt werden, weil der Empfänger am Bestimmungsort nicht festgestellt werden kann, gehen dadurch entstehende Zeitverzögerungen und Kosten für weitere Anfahrten zu Lasten des Bestellers.
4. Aus versandtechnischen Gründen sind alle im Katalog mit 2,7 m ausgezeichneten Profile nur 2,69 m lang (Handelsbezeichnung bleibt weiterhin 2,7 m). Bei Bestellungen innerhalb Deutschlands ab 450 € netto erfolgt die Lieferung frei Haus. Unter 450 € wird eine Kostenpauschale von 25 € berechnet. Unter 75 € erheben wir zusätzlich einen Mindermengenaufschlag von 8 €. Diese Bedingungen gelten für Lieferungen bis 2,69 m Länge. Lieferungen über 2,69 m erfolgen nur mit Spedition. Die Transportkostenhöhe ergibt sich aus Gewicht und Länge der Sendung. Für Baustellenanlieferungen ist generell ein Telefonavis mit aktueller Telefonnummer auf Kundenkosten (+6 €) Pflicht, um Anlieferungsprobleme, Verzögerungen und Zusatzkosten zu vermeiden.
5. Die Zahlungsfrist beträgt 10 Tage 3 % Skonto oder 30 Tage netto. Für Vorauskasse, Nachnahme und Bankeinzug gelten 4 % Skonto. Bis zur vollständigen Bezahlung der gelieferten Ware bleibt diese Eigentum des Lieferanten. Bei Zahlungsverzug sind wir berechtigt Verzugszinsen entsprechend den gesetzlichen Bestimmungen zu berechnen.
6. Gerichtsstand und Erfüllungsort für beide Vertragsteile ist Sitz des Lieferanten. Schadenersatz- und Aufwendungsersatzansprüche des Käufers, gleich aus welchem Rechtsgrund, insbesondere wegen Verletzung von Pflichten aus einem Schuldverhältnis und aus unerlaubter Handlung, sind ausgeschlossen. Dies gilt nicht, soweit nach gesetzlichen Vorschriften oder Garantie zwingend gehaftet wird. Bei Reklamationen von Transportschäden bitten wir Sie für Begutachtungen die Verpackung aufzuheben.
7. Nach §§ 26 und 34 Bundesdatenschutzgesetz sind wir verpflichtet, Sie davon in Kenntnis zu setzen, dass wir Daten Ihrer Firma bei uns speichern und verarbeiten. Selbstverständlich sind davon nur solche Angaben betroffen, die geschäftsnotwendig sind und direkt aus unserer Geschäftsbeziehung stammen.
8. Warenrücknahme erfolgt nur nach ausdrücklicher Genehmigung durch uns. Die Rücksendung ist in jedem Fall franko und in transportsicherer Verpackung vorzunehmen. Bei Rücksendungen, die nicht auf unser Verschulden zurückzuführen sind, erheben wir eine Wiedereingliederungspauschale von 15%. Sonderanfertigungen werden nicht zurückgenommen.
9. Bei Sonderlängenzuschnitten in Einzellängenherstellung berechnen wir den anfallenden Materialverbrauch zuzüglich einem Arbeitsaufschlag von 15%. Ab einer Serienfertigung von 30 Stück je Profil und Länge entfällt der Arbeitsaufschlag (Ausnahme: Läuferstangen).
10. Alle Preise sind zuzüglich Mehrwertsteuer.
11. Dieser Katalog, inkl. Liefer- & Zahlungsbedingungen, tritt ab 01.01.2024 in Kraft. Ältere Kataloge und die bisherigen Liefer- & Zahlungsbedingungen verlieren damit ihre Gültigkeit. Wir behalten uns vor kurzfristig unterjährig einen Teuerungsauflschlag einzuführen.

Umsatzsteueridentnummer: DE 141030233

AG Chemnitz HRB 2292

ILN 40 17589 00000 6



Unsere Bankverbindungen:

Deutsche Bank

IBAN: DE59 8707 0000 0747 1758 00

BIC: DEUTDE8CXXX

Commerzbank Aue

IBAN: DE12 8708 0000 0660 3452 00

BIC: DRESDEFF870

terms and conditions

1. General product descriptions, drawings, pattern, illustrations and dimensions are not binding. The data are therefore binding only after written confirmation. This also applies to information, advice and recommendations of our employees. Production-related variations in colour, design or shape changes remain reserved, unless a significant change in the purchase item arises.
2. All deliveries are subject to the prices and discounts valid at the time of the delivery. The customer accepts the terms and conditions as legally binding.
3. Goods in stock are usually dispatched within 14 days (or sooner after prior agreement, the customer may be subject to additional charges). The customer should make suitable arrangements to receive the goods at the specified address. Deliveries usually require a signature. The delivery service may not search for the recipient at delivery time. If the goods cannot be delivered on time because the recipient cannot be determined at the destination, any resulting delays and costs for further delivery attempts will be borne by the customer.
4. For technical reasons, all the 2.7 m profiles in the catalog are only 2.69 m long (trade name remains 2.7 m). These terms apply to deliveries. Deliveries over 2.69 m are only possible with forwarding. The transport cost is calculated from the weight and length of the consignment. For deliveries to construction sites, a telephone notification with a current telephone number is generally required at the customer's expense (+6 €) in order to avoid delivery problems, delays and additional costs.
5. Payment within 10 days permits a 3 % discount. Payment within 30 days of the net amount. Prepayment, cash on delivery, or bankers draft are subject to a 4 % discount. Goods stay the property of the manufacturer until they are fully paid. For late payments we charge interest according to law.
6. Court of jurisdiction and place of fulfillment for both parties to a contract is the registered office of the supplier. In case of complaints about transport damages please retain the packaging for appraisals.
7. According to §§ 26 and 34 of the German Data Protection Act we are obliged to let you know that we store and process data of your business. We only store and process data which is necessary for conducting business and directly originate from our business relation.
8. Goods returns are only accepted after explicit prior permission by us. The return should be postage paid and the goods packed in suitable packaging. For returns which are not due to our mistakes we charge a 15% restocking fee. Custom made orders are not returnable.
9. Custom lengths are chargeable at cost of materials plus 15% extra labour costs. For custom orders of 30 pieces or more of a single profile and length, we waive the additional labour costs (exception: stair rods).
10. All prices are exclusive of VAT.
11. This catalog, including delivery and payment conditions, comes into force on 01.01.2024. Older catalogs and the previous terms of delivery and payment lose their validity. We reserve the right to introduce a surcharge at short notice during the year.

VAT registration number: DE 141030233

AG Chemnitz HRB 2292

ILN 40 17589 00000 6



Our bank details:

Deutsche Bank

IBAN: DE59 8707 0000 0747 1758 00

BIC: DEUTDE8CXXX

Commerzbank Aue

IBAN: DE12 8708 0000 0660 3452 00

BIC: DRESDEFF870



EDELSTAHL-TREPPENKANTEN (Werkstoff 1.4301)

Treppenkanten mit profilierter Riffelung 1,5 mm stark, **Rutschhemmung R10**

10 x 30 x 1,5 mm

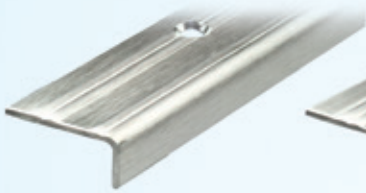

20 x 30 x 1,5 mm

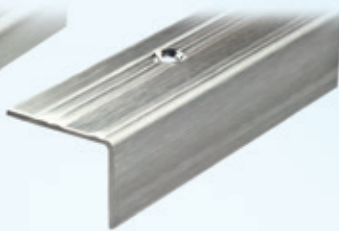

30 x 30 x 1,5 mm

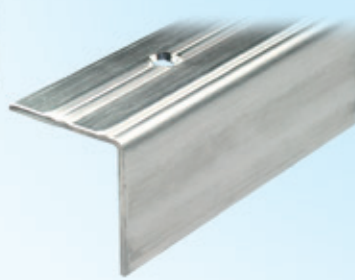

20 x 40 x 1,5 mm

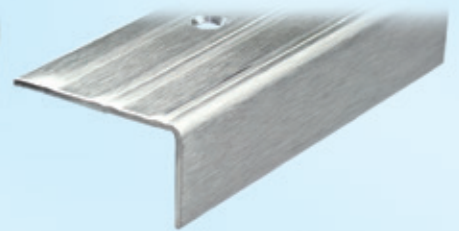

Treppenkanten mit gefräster Riffelung 3,0 mm stark

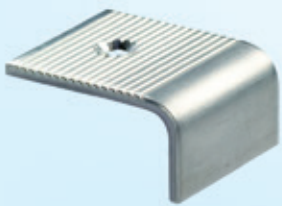

20 x 40 x 3 mm

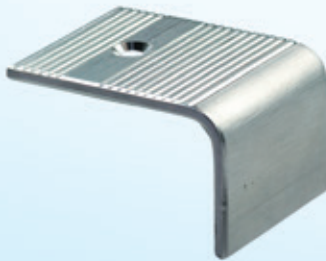

28 x 50 x 3 mm

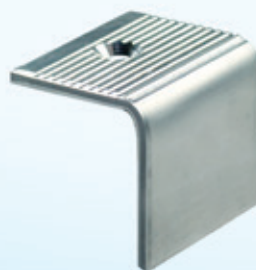

30 x 30 x 3 mm

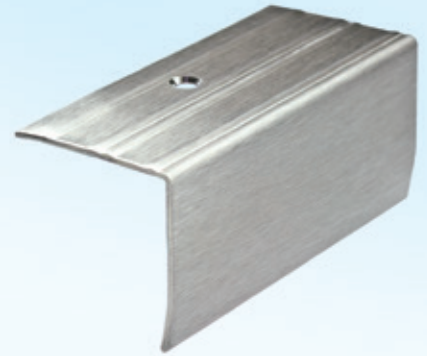

40 x 40 x 1,5 mm

Einschubprofile mit Nase 1,5 mm stark

Höhe des Einschubes nach Bedarf

Einschubprofil mit Nase

Sicherheitsriffelung 3,0 mm

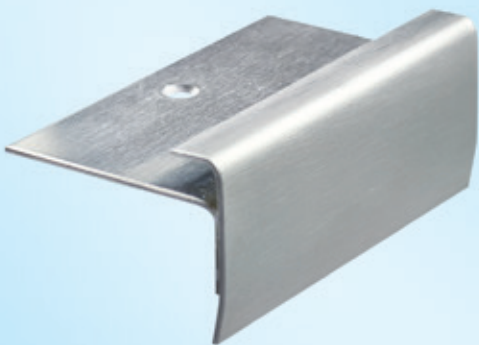

10 x 40 x 1,5 mm

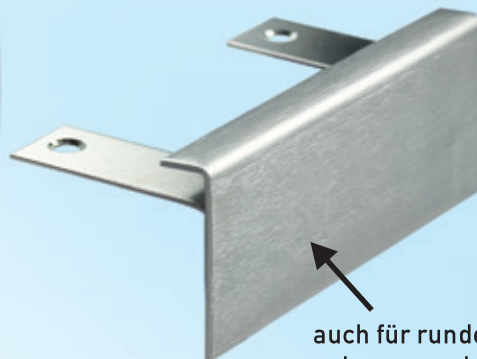

10 x 40 x 1,5 mm

auch für runde Stufen möglich,
gebogen nach Schablone,
Radius oder Skizze

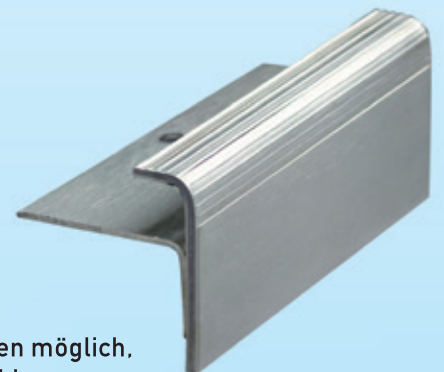

10 x 40 x 3 mm

EDELSTAHL-TREPPENKANTEN (Werkstoff 1.4301)

Treppenkanten mit Prägelochung 1,5 mm stark, **Rutschhemmung R12**

10 x 30 x 1,5 mm

10 x 30 x 1,5 mm (Anker)

20 x 40 x 1,5 mm

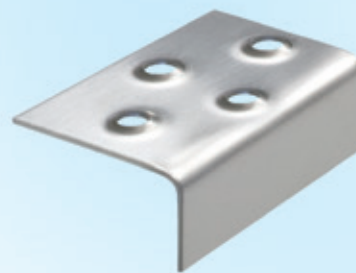
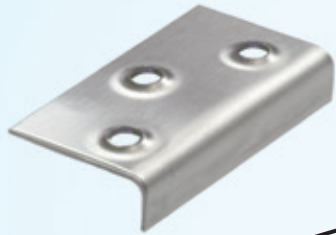

mit Anker: zum Einbetten in Beton oder zum nachträglichen Einkleben mit Spezialkleber (Diebstahlschutz)

ohne Anker: zum nachträglichen Verschrauben auf der Stufe

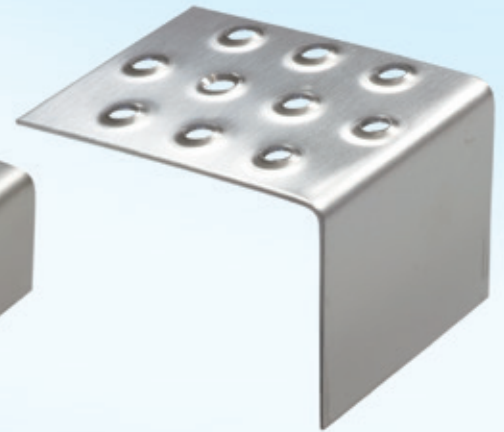
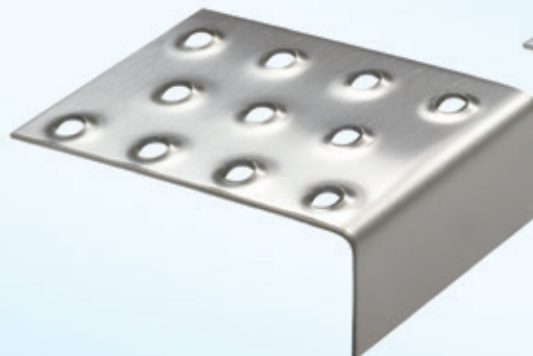
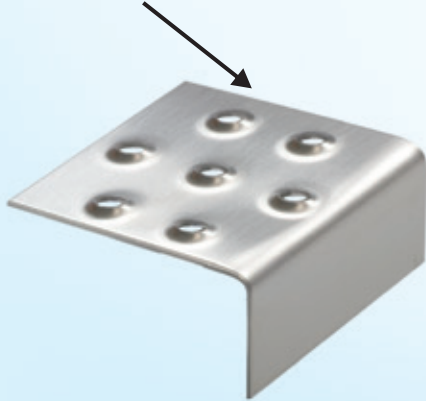

25 x 60 x 1,5 mm

25 x 80 x 1,5 mm

50 x 80 x 1,5 mm

Treppenkanten mit Prägelochung kommen bei Einrichtungen wie Bahnhöfen, Flughäfen, Skigebieten, Clubs, Diskotheken, Seniorenheimen, Krankenhäusern, Ämtern und Behörden zum Einsatz. Sie können aber auch hervorragend zur Treppensanierung eingesetzt werden.



Läuferstange 25 mm

Messing poliert,
lackiert

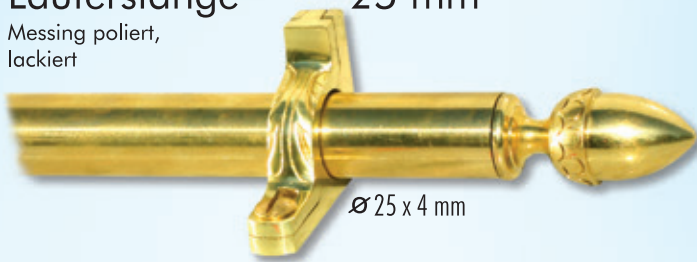

Läuferstange 10 mm

Messing poliert,
lackiert

Ø 10 x 0,8 mm
mit & ohne Stahlkern



Läuferstange 16 mm

Messing poliert,
lackiert

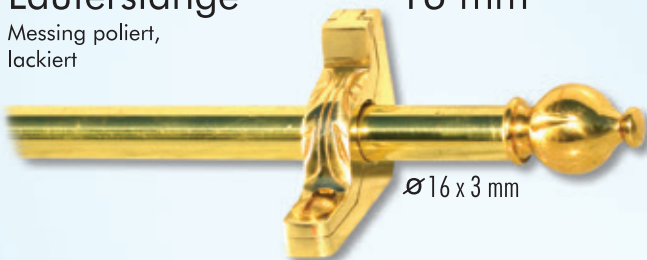

Läuferstange 10 mm

Edelstahl poliert

Ø 10 x 1,5 mm



Läuferstange 10 mm

Weiß beschichtet

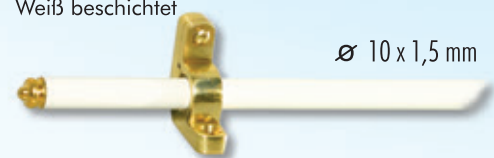

Läuferstange 16 mm

Edelstahl
matt geschliffen

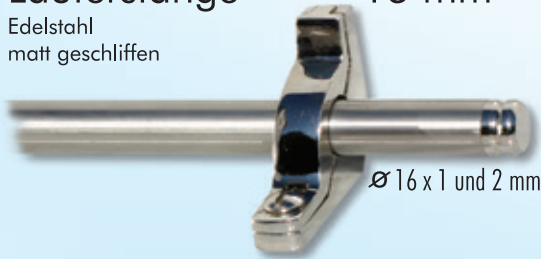

Läuferstange 10 mm

Schwarz matt

Ø 10 x 1,5 mm



Dreikantläuferstange 16 mm

Messing poliert & lackiert,
Messing vernickelt



Läuferstange 10 mm

Kupfer antik

Ø 10 x 1,5 mm



Läuferstange 13 mm

Messing poliert & lackiert,
Edelstahl poliert und matt geschliffen
Ø 13 x 1 mm
mit & ohne Stahlkern



Läuferstange 10 mm

Edelstahl
matt geschliffen

Ø 10 x 1,5 mm

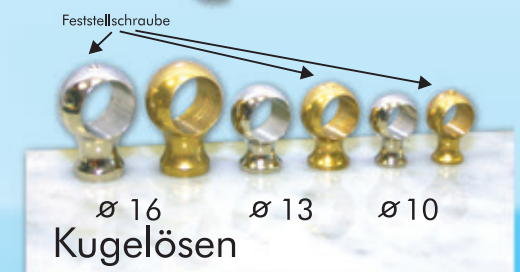
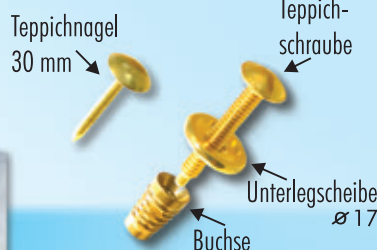



PROFILE ZUM BIEGEN

Artikel, die mit diesen Zeichen versehen sind, stanzen und biegen wir für Sie nach Angabe des Radius oder nach Schablone.



ausklinken

+



biegen

Treppenkanten

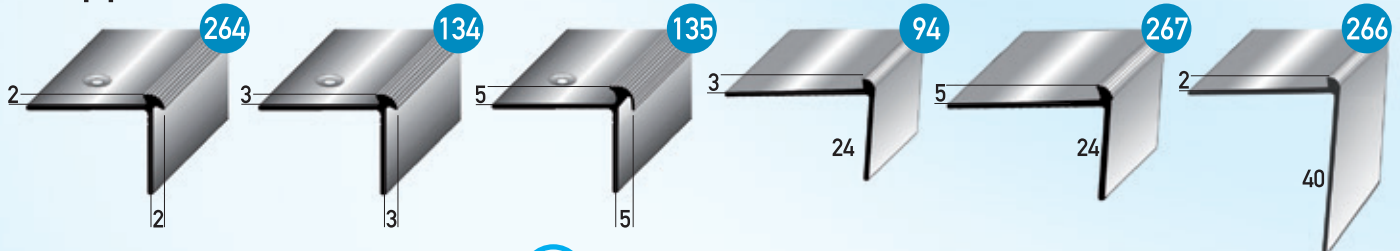

Einschubprofile

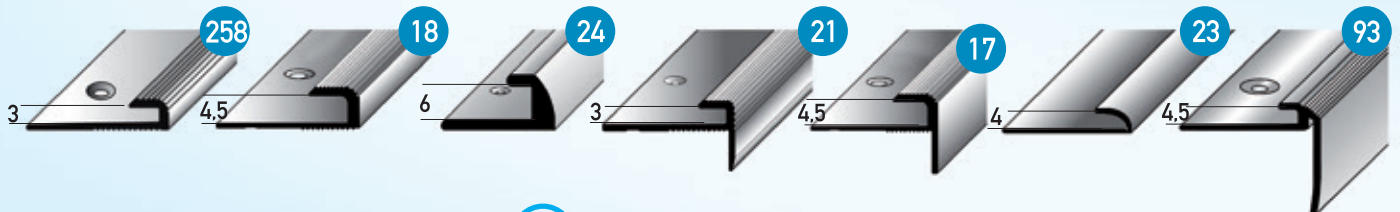

Einfäßschienen



Profile für Laminat / Parkett

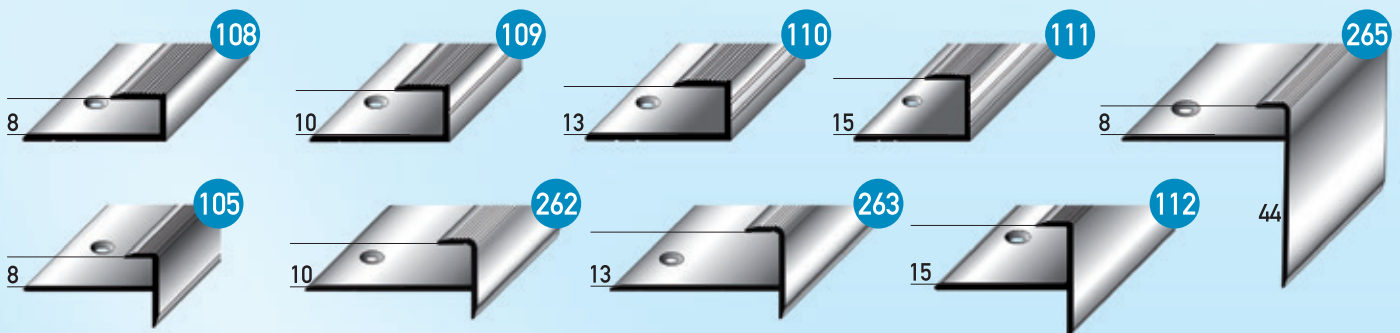

T-Profile

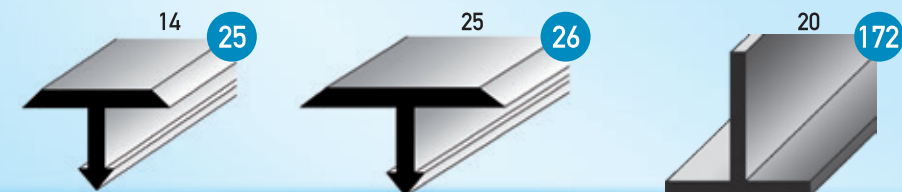

Treppenkanten mit abriebfester und nachleuchtender Spezialemailierung

für bodennahe Leitsysteme nach BGR 216

Krankenhäuser, Seniorenheime, öffentl. Gebäude, Schiffe, Flughäfen, Tiefgaragen, Hotels usw.

20 x 40 mm

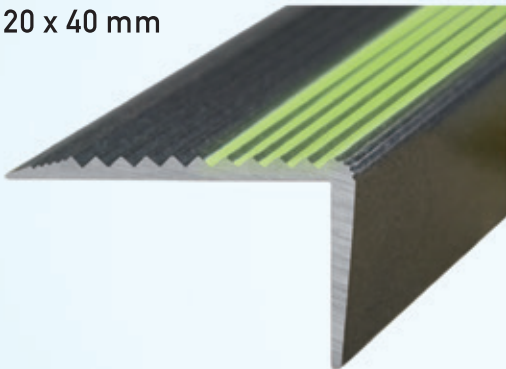

Leuchtzeit:

1 Stunde stark bei einer Mindestbeleuchtung von 100 Lux für ca. 5 min.

Alu-Profil mit lang nachleuchtendem Email, unbegrenzt oft wiederholbarer Nachleuchteffekt. Vollständige Beschichtung möglich - auch für andere Profile. Eigenschaften:

abriebfest, desinfizierbar, keimabweisend, witterungsbeständig.

Das Material besteht aus ungiftigem und gefähndungsfreiem Erdalkalialuminat und ist als Aluschrott recyclingfähig.

Schwarz
20 x 40

Grün
20 x 40

Rot
20 x 40

Treppenkante mit LED-Beleuchtung

für Krankenhäuser, Seniorenheime, öffentliche Gebäude, Schiffe, Flughäfen, Tiefgaragen, Hotels, Gaststätten, Diskotheken, usw.

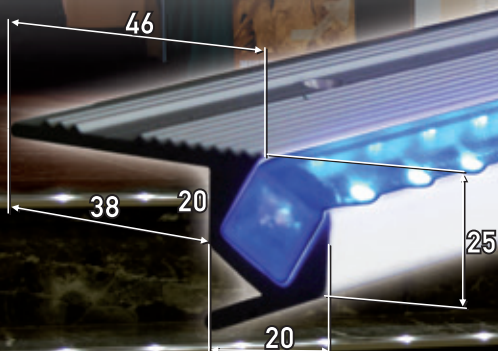

Blau
20 x 40

Gold
20 x 40

Profil-Farben: Silber, Gold, Bronze hell, Bronze dunkel, Edelstahlfarbig

LED-Farben: transparent, blau, rot, grün, gelb, lila - auf Wunsch mit Dimmer

Beleuchtungsleiste: 12V = 10 LED/lfm., alternativ 12 V = 30 LED/lfm.

Preise auf Anfrage

Silber
metallisch
20 x 40

Dunkelgrau
20 x 40



Bohren / drilling



Profilieren / profiling



Abkanten / folding

**Nachleuchtende Treppenkanten
luminescent stair nosings**

**LED-beleuchtete Treppenkanten
LED-illuminated stair nosings**

**Edelstahlbeschichtete Treppenkanten
mit abriebfester Spezialemailierung
stainless steel coated stair nosings
with abrasion-resistant special enamelling**

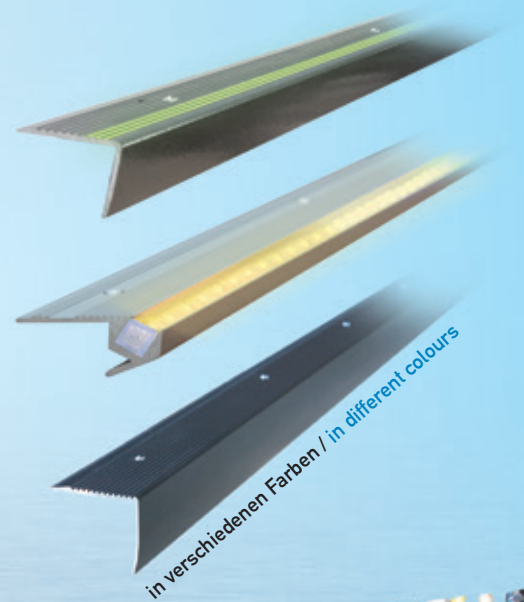

**Jedes Profil in Folie eingeschumpft,
mit Schrauben, Dübel und EAN-Code versehen.**
Every profile is shrink-wrapped in foil
with screws, dowels and European Article Number (EAN)



Auer Metallprofile GmbH
Muldenstraße 2
D-08280 Aue / Sachs.

Tel. +49 (0) 3771 / 28 68-0
Fax +49 (0) 3771 / 28 68-13
www.Auer-Metallprofile.de
info@Auer-Metallprofile.de



Unser Service für Sie:

Our service for you:



Kurze Lieferzeiten
(48 Stunden in Deutschland möglich)
short delivery times
(48 hours intrastate possible)



Keine Mindestabnahmemenge
minimum purchase quantity



Zuschnitte für Sonderlängen
special cuts of lengths



Abkantprofile nach Skizze
folded profiles according to your sketch



Biegen von Profilen
bending of profiles



Oberflächenbearbeitung
(vergolden, schleifen, polieren)
surface processing
(gilding, grinding, polishing)



**Flexible Farbgestaltung mit Eloxal-,
Emaille- und RAL-Farben**
Flexible colour design with anodized, enamel
and RAL colours

